



Catalog | June 2016

Electronic relays and controls

The whole assortment for monitoring and controlling devices

Electronic relays and controls

News



Liquid level monitoring relays in new housing

ABB's liquid level monitoring relays are used for regulation and control of liquid levels and ratios of mixtures of conductive fluids. The assortment includes single function and multifunctional devices which can be used for overflow, dry-running protection of pumps, filling and draining applications as well as max. and min. level alarm. A range of accessories like different electrodes complete the offer.

The new housing provides two different connection terminals: The proven double-chamber cage connection terminals and the Easy Connect Technology with Push-in terminals.



The slim line of interface relays and optocouplers

The pluggable interface relays and optocouplers of the CR-S Range are used for electrical isolation, amplification and signal matching between the electronic controlling, e.g. PLC, iPC or field bus systems and the sensor / actuator level. The CR-S Range combines the flexibility of a modular system and the ability of switching high currents on a small footprint thus can be used in applications where space saving is essential.



Universal Motor Controller UMC100.3 now available with additional analog temperature module A111

The intelligent ABB Motor Controllers for motor protection, motor control, fieldbus and Ethernet communication and fault diagnosis. Due to the benefits it provides, the UMC is used worldwide in many segments and in Projects with several thousand motor controllers. Beside the proven UMC100 the new UMC100.3 offers even more capabilities like 24 V DC or 110-220 V AC/DC supply voltage and fieldbus communication interfaces. Different modules like the newest analog and temperature module A111 extend the functional scope.



Short form catalog

The smaller brother of this binder. It includes all necessary information to select a product.

Electronic relays and controls

Further marketing tools and technical data



Selection app

Finding the right product within a large product range could be a difficult task. Electronic relays and controls selection tool will help you quickly and easily select your products in few easy steps.

Android version



iOS version

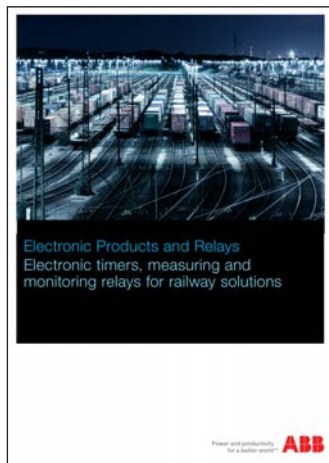

Rail brochure

Selected products of the electronic timers and measuring and monitoring relays comply to the latest rail standards NF F 16-101/102, EN 45545, EN 50155 and more standards which are relevant for railway applications.



Electronic relays and controls

Table of contents

Electronic timers	1/1	1
Measuring and monitoring relays	2/1	2
Primary switch mode power supplies	3/1	3
Analog signal converters, serial data converters	4/1	4
Interface relays and optocouplers	5/1	5
Logic relays	6/1	6
Index	7/1	7

Approvals and marks for the world market

















Overview

ABB low-voltage switching devices are developed and produced in accordance with the applicable regulations as stated in the international IEC publications, the European EN specifications and the national VDE standards.

In most countries, low-voltage switching devices are produced according to such regulations under the responsibility of the manufacturers. This is why the devices are not subject to further approval. However, for those devices which are intended for use in household or for public use our customers can request test reports of our internal laboratory for presentation to the various qualified local organizations. In other countries, approvals are prescribed by law.

For devices installed in ships, an approval issued by independent shipping companies, such as the GL, are demanded by the maritime insurance companies.

Marks of conformity and examples of approvals (device-dependent)

<p>International</p> <p>CB scheme </p> <p>The CB (Certification Body) Scheme is a system designed to facilitate international trade by establishing mutual acceptance of test reports among participating safety certification organizations (the National Certification Bodies) in more than 30 countries. The CB Scheme was established by the International Electrotechnical Committee for Conformity Testing to Standards for Electrical Equipment (IECEE).</p>	<p>Berufsgenossenschaft der Feinmechanik und Elektrotechnik (BGFE) </p> <p>The BG-PRÜFZERT sign is a voluntary safety mark, awarded by the BGFE following successful safety testing.</p> <hr/> <p>Explosion protection (EX) </p> <p>Explosion protection acc. to Directive 94/9/EG (ATEX 100a)</p> <hr/> <p>Swiss insurance institution (SUVA) </p> <p>Department accident prevention suvaPRO</p>	<p>China</p> <p>CCC (China Compulsory Certification) </p> <p>In China the CCC certification mark is a compulsory certification mark in the field of safety and quality for products sold on the Chinese market.</p> <hr/> <p>North America</p> <p>Canadian and US standards are more or less equivalent but considerably differ from the IEC and VDE regulations.</p>
<p>Europe</p> <p>Conformité Européen (CE) </p> <p>All devices which comply with the European low voltage directive and which are intended for sale within the European Union must have the CE sign applied. All products in this catalog are CE marked.</p> <p>The CE sign must not be confused with a certificate of quality issued by the EU. It is solely used to confirm that the respective product complies with the applicable European directives *). The CE sign is part of an administrative procedure to guarantee free movement of goods within the European Community.</p> <p>*) Directives: Low Voltage Directive 2006/95/EC EMC Directive 2004/108/EC Machinery Directive 98/37/EEC</p>	<p>Germanischer Lloyd (GL) </p> <p>Shipping approval</p> <hr/> <p>Lloyds Register </p> <p>Shipping approval</p> <hr/> <p>Russia</p> <p>In Russia, low-voltage switching devices are subject to certification and have to be provided with a sign.</p> <hr/> <p>Eurasian Conformity </p> <p>EAC certification is mandatory for many products. This certification is based on a safety test (IEC standards with Russia-specific deviations) and an EMC test.</p> <hr/> <p>Russian Maritime Register of Shipping RMRS </p> <p>Shipping approval</p>	<p>USA</p> <p>Underwriters Laboratories (UL) Listing </p> <p>Released for installation in systems and for sale as individual component in the USA.</p> <hr/> <p>Recognition </p> <p>Released for installation in systems, if the respective system has been completely mounted and wired by qualified personnel.</p> <hr/> <p>Canada</p> <p>Canadian Standards Association (CSA) </p>
<p>Verband der Elektrotechnik Elektronik Informationstechnik (VDE) </p> <p>Applicable for technical instruments covered by the German Gerätesicherheitsgesetz (GSG) as well as for single parts and electrical wiring devices.</p>	<p>Australia, New Zealand</p> <p>RCM Mark </p> <p>The RCM Mark certifies compliance with the Australian EMC requirements. The Mark is also recognized in New Zealand.</p>	<p>USA and Canada</p> <p>The combined UL signs for the USA and Canada are recognized by the authorities of both countries. Devices with this certificate meet the requirements of both countries.</p> <p>Listing </p> <p>Recognition </p>

Find Electronic relays and controls product information and documentation on our web page

The following steps will guide you to the **documentation** and **product search** section of the Electronic relays and controls portfolio on www.ABB.com.

Enter <http://new.abb.com/low-voltage/products/electronicrelays> in your internet browser.
You will be redirected to the following page:

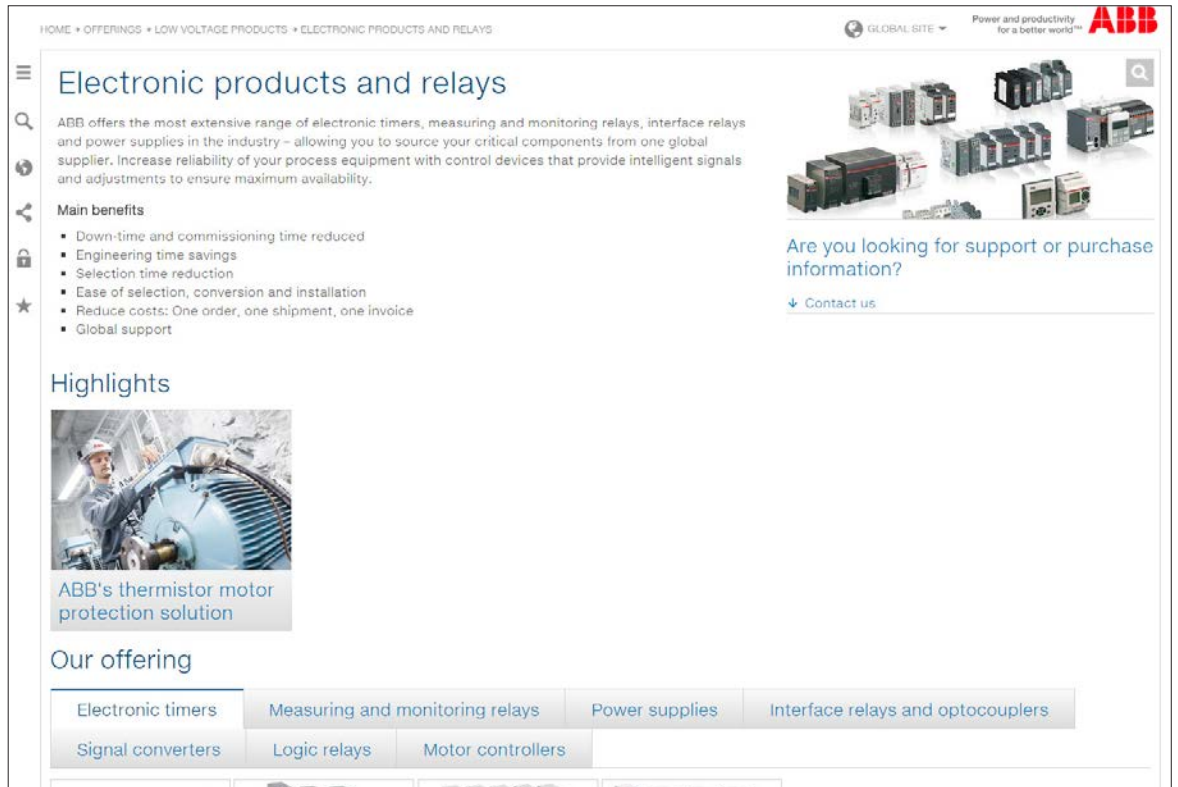

Latest information about the Electronic relays and controls product range could be found in the **Highlights** section.

In the lower area of the web page you can find the **Our offering** section.

The assortment of the Electronic relays and controls range is listed here as shown in the screenshot below:

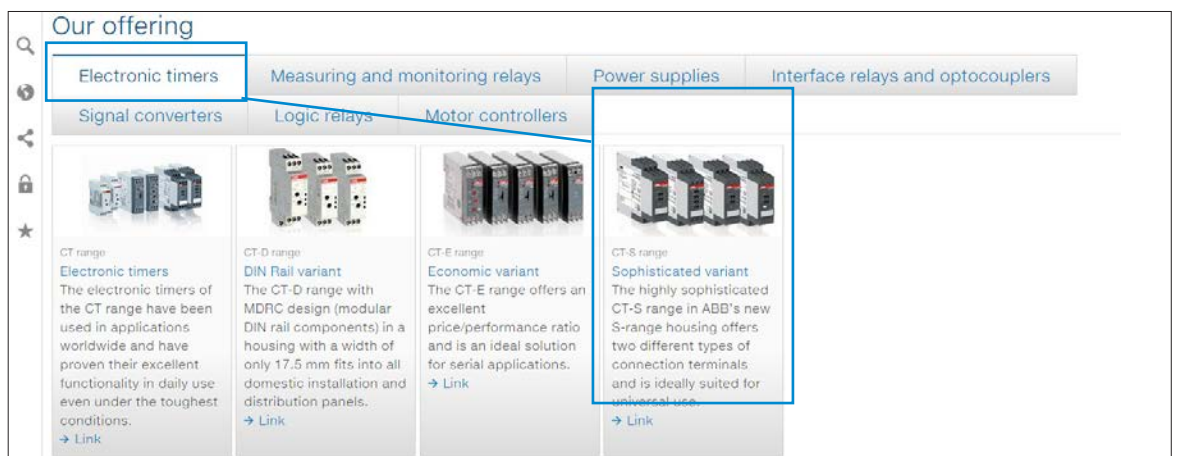

Select the register of the relevant product group to see all the products related to the product group.

Choose a product range from which you want to see the documentation or from which you want to choose a specific product.

In this example the **CT-S range** from the register **Electronic timers** has been selected as shown on the screenshot.

Find Electronic relays and controls product information and documentation on our web page

You will be redirected to the following page:

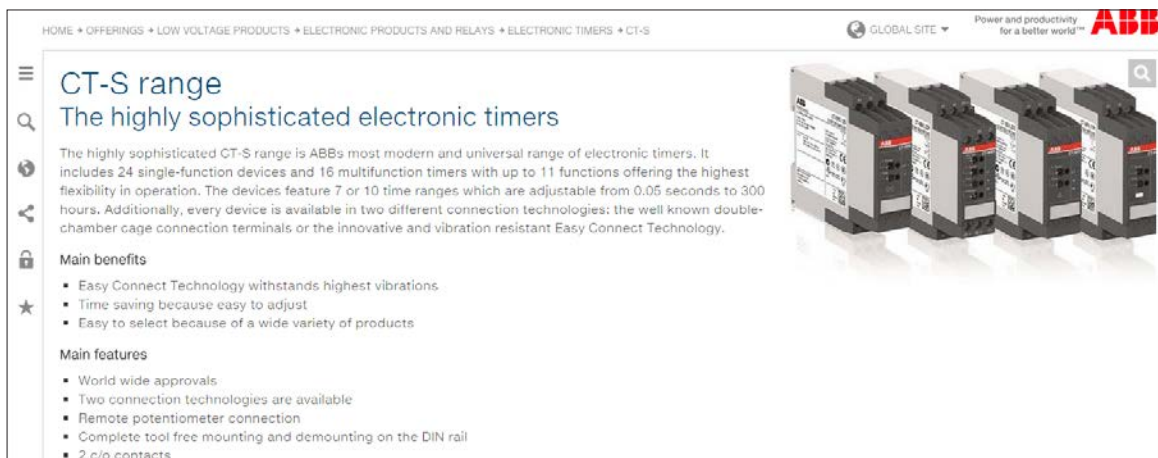

Latest information about the Electronic relays and controls product range could be found in the **Highlights** sections.

In the lower area of the web page you can find the **Products and documents** section.

The functions to choose a product or a document are listed here as in the screenshot below:

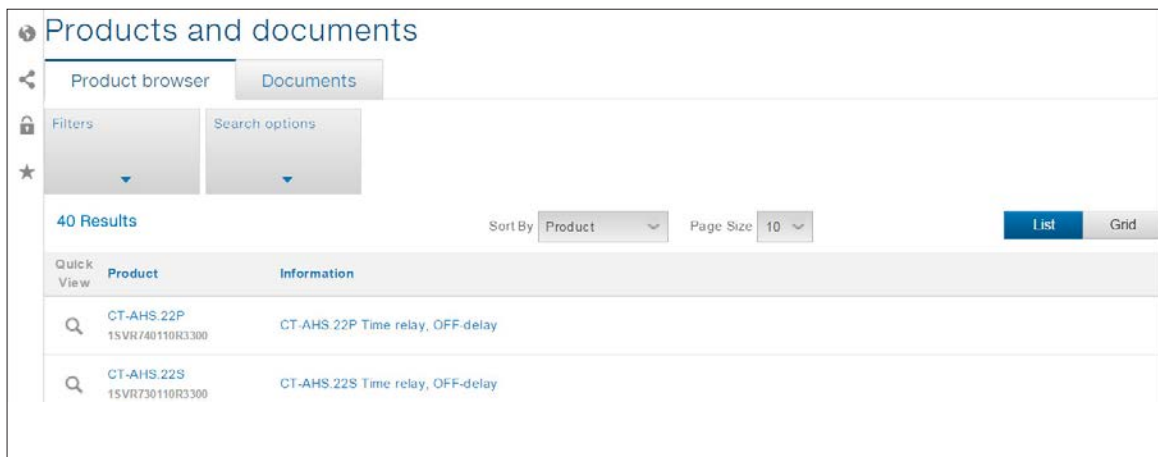

To search for a product continue **on page 9**.

To search for documentation continue **on page 10**.

Find Electronic relays and controls product information and documentation on our web page

How to find the right product

Click on **Filters** to see the different search attributes for the selected product range.
The filter section will be expanded as shown below.

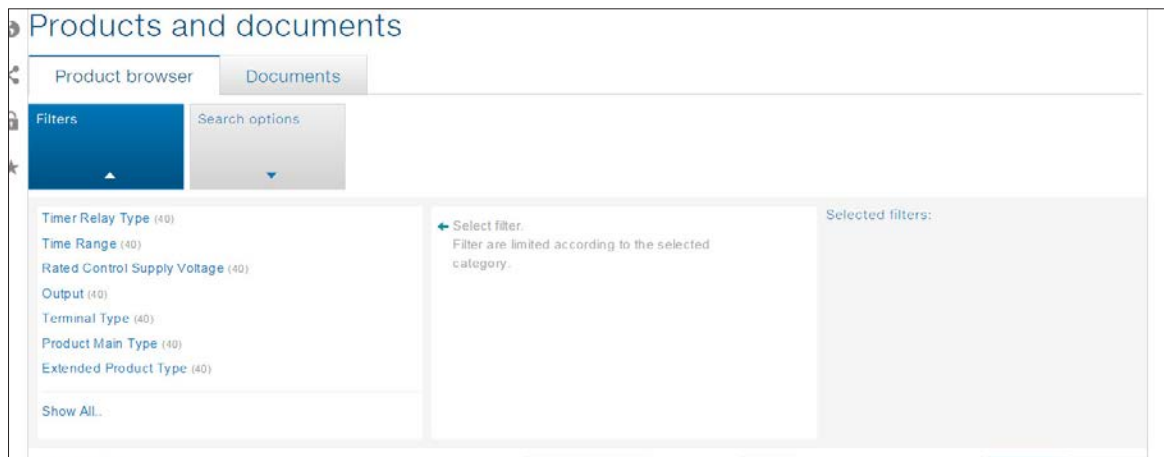

The different product filters are shown.
Click on the filter attribute to continue the product search process.
In this example **Output** has been chosen.

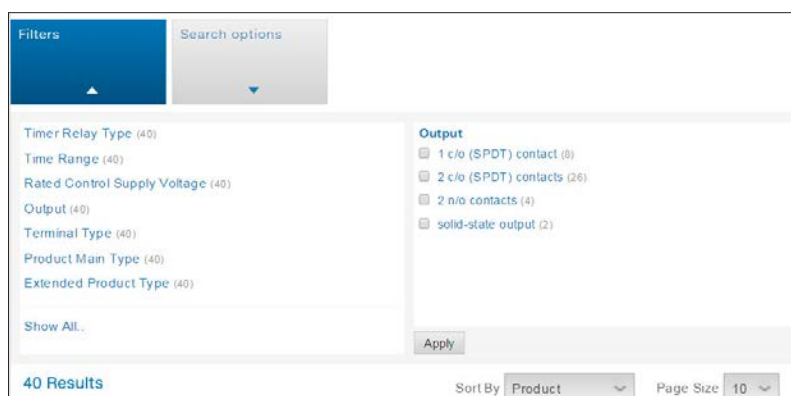

In the right part mark the corresponding check box to narrow down the search. You can also select several check boxes.
Click on **Apply** to submit your filter.
The search results are now listed according to your selection.
Proceed this approach with different filters until the right product is listed.
Click on the product in the **Result section** to get the dedicated product information listed in your browser.

Find Electronic relays and controls product information and documentation on our web page

How to find the right documentation

Click on **Documents** to see the different types of documentation for the product.
The document section will be expanded as shown below.

The screenshot shows a web interface titled "★ Products and documents". It has two tabs: "Product browser" and "Documents", with "Documents" being the active tab. Below the tabs is the heading "Download related documents for CT-S". Underneath, there is a section for "Available documents:" with links for "Advanced search" and "Documents in all languages". On the left side, there is a vertical list of document categories: "Show all (50)", "Popular documents (5)", "Brochure (3)", "Catalogue (1)", "Certificate (14)", "Data sheet (20)", "Declaration of conformity (5)", and "Instruction (7)". The "Popular documents (5)" category is selected, indicated by a right-pointing arrow. The main content area on the right displays a list of five documents, each with a title, a brief description, the language(s), date, and size, and a PDF download icon.

Document Type	Count
Show all	50
Popular documents	5
Brochure	3
Catalogue	1
Certificate	14
Data sheet	20
Declaration of conformity	5
Instruction	7

Document Title	Language(s)	Date	Size	Format
Data sheet - Electronic timer CT-SDS 22P; CT-SDS 22S	English	2012-08-28	1,31 MB	PDF
Instruction Sheet / Manual - CT-AHS, CT-ARS, CT-MBS, CT-MFS with screw or push-in terminals	English, Chinese, French, German, Italian, Russian, Spanish	2012-09-14	0,62 MB	PDF
RMRS Certificate - Electronic Timers CT-D, CT-E and CT-S range	English, Russian	2012-07-18	0,30 MB	PDF
Instruction Sheet / Manual - CT-MXS, CT-WBS with screw or push-in terminals	English, Chinese, French, German, Italian, Russian, Spanish	2011-07-19	0,59 MB	PDF
Data sheet - Electronic timer CT-APS 21P; CT-APS 21S suited for rail applications	English	2014-01-14	0,90 MB	PDF

On the left side select the type of document related to the product. In the example **Popular documents** has been selected.
In the right area click on the document related to the product.
The document is opened or downloaded, depending on the individual browser settings.

Electronic relays and controls catalog 2016

Notes

Electronic timers

Product group picture

1



Electronic timers

Table of contents

Electronic timers

Electronic timers	12
Type selection	13
Approvals and marks	14
CT-D range	16
Benefits and advantages	17
Ordering details	18
Connection diagrams	19
Technical data	20
Technical diagrams, Wiring notes, Dimensional drawings	22
CT-E range	24
Benefits and advantages	25
Ordering details	26
Connection diagrams	28
Connection diagrams, Technical diagrams	29
Technical data	30
Wiring notes, Dimensional drawings	32
CT-S range	34
Benefits and advantages	35
Ordering details - multifunctional	37
Ordering details - singlefunctional	38
Ordering details - Accessories	39
Connection diagrams	40
Technical data	42
Technical diagrams	45
Wiring notes, Dimensional drawings	46
Electronic timers	47
Timing functions	47

Electronic timers

Type selection



CT-D range in modular DIN rail housing

- Time ranges: 7 (0.05 s - 100 h)
- CT-SDD, CT-SAD: (0.05 s - 10 min)
- Wide and multi ranges of control supply voltage
- 1 or 2 c/o contacts
- CT-SDD, CT-SAD: 2 n/o contacts
- Control inputs: voltage-related triggering, polarized, capable of switching a parallel load

CT-E the economic range

- Multifunction devices: 8 (0.05 s - 100 h)
- Single-function devices: 0.05-1 s, 0.1-10 s, 0.3-30 s, 3-300 s, 0.3-300 min
- Wide, single and dual ranges of control supply voltage
- 1 c/o contact
- CT-SDE: 1 n/o contact and 1 n/c contact
- CT-MKE, CT-EKE, CT-AKE: 1 thyristor
- voltage-related triggering, polarized
- CT-MFE, CT-AHE, CT-AWE: with auxiliary voltage

CT-S the high-performance range









- 10 (0.05 s - 300 h)
- CT-ARS, CT-SDS: 7 (0.05 s - 10 min)
- Wide, single and multi ranges of control supply voltage
- 1 or 2 c/o contacts
- CT-MVS.21, CT-MFS, CT-MBS: 2nd c/o contact selectable as inst. contact
- CT-SDS: 2 n/o contacts
- voltage-related triggering, non-polarized, capable of switching a parallel load
- CT-MFS, CT-MBS, CT-AHS: volt-free triggering

		multifunctional	single-functional	multifunctional	single-functional	multifunctional	single-functional
Timing function		CT-D		CT-E		CT-S	
☒ ON-delay		CT-MFD	CT-ERD	CT-MFE, CT-MKE	CT-ERE, CT-EKE	CT-MVS, CT-MFS, CT-MBS, CT-WBS	CT-ERS
■ OFF-delay		CT-MFD	CT-AHD	CT-MFE	CT-AHE, CT-ARE, CT-AKE	CT-MVS, CT-MFS, CT-MBS	CT-APS, CT-AHS, CT-ARS
☒■ ON- and OFF-delay						CT-MVS, CT-MXS, CT-MFS, CT-MBS	
1☒ Impulse-ON		CT-MFD	CT-VWD	CT-MFE, CT-MKE	CT-VWE	CT-MVS, CT-MFS, CT-MBS, CT-WBS	
1■ Impulse-OFF		CT-MFD			CT-AWE	CT-MVS, CT-MFS, CT-MBS	
1☒■ Impulse-ON and OFF						CT-MXS	
☒ Impulse starting with ON		CT-MFD	CT-EBD	CT-MFE, CT-MKE		CT-MFS, CT-MBS, CT-WBS	
■ Impulse starting with OFF		CT-MFD		CT-MFE, CT-MKE	CT-EBE	CT-MFS, CT-MBS, CT-WBS	
☒ Impulse starting with ON or OFF						CT-MVS	
☒ Pulse generator starting with ON or OFF			CT-TGD			CT-MXS	
☒ Pulse former		CT-MFD		CT-MFE		CT-MVS, CT-MFS, CT-MBS	
△ Star-delta change-over			CT-SDD, CT-SAD				CT-SDS
△ Impulse Star-delta change-over with impulse					CT-SDE	CT-MVS.2x, CT-MFS, CT-MBS	
△ Impulse twice ON-delayed					CT-YDE		
☒+ ☒ Impulse further functions (depending on device)						CT-MVS, CT-MXS, CT-MFS, CT-MBS, CT-WBS	

A detailed explanation of the different timing functions can be found at "Timing functions" on page 47.

Electronic timers

Approvals and marks

		CT-D	CT-E	CT-S
	UL508, CAN/CA C22.2 No. 14	All	All	All
	CB Scheme	All except: CT-MFD.21, CT-ERD.22, CT-AHD.22, CT-TGD.22, CT-SDD.22, CT-SAD.22	All except: CT-MKE, CT-EKE, CT-AKE	All
	EAC	All	All	All
	CCC	All	All except: CT-MKE, CT-EKE, CT-AKE	All
	RMRS	All except: CT-SDD.22, CT-SAD.22	All	All
	Germanischer Lloyd	-	All	All available Pending for: CT-ARS.11
	Communauté Européenne	All	All	All
	RCM	All available Pending for: CT-MFD.21, CT-ERD.22, CT-AHD.22, CT-TGD.22, CT-SDD.22, CT-SAD.22	All	All

CT-D range Product group picture

1



CT-D range

Table of contents

CT-D Range

CT-D range	16
Benefits and advantages	17
Ordering details	18
Connection diagrams	19
Technical data	20
Technical diagrams, Wiring notes, Dimensional drawings	22

CT-D range

Benefits and advantages

1

Characteristics

- Diversity:
 - 2 multifunction timers
 - 10 single-function timers
- Control supply voltages:
 - Wide range: 12-240 V AC/DC
 - Multi range: 24-48 V DC, 24-240 V AC
- 7 time ranges from 0.05 s to 100 h or
4 time ranges from 0.05 s to 10 min
- Width of only 17.5 mm
- Light-grey housing in RAL 7035
- Devices with:
 - 1 c/o contact (250 V / 6 A) or 2 c/o contacts (250 V / 5 A)
 Control input: voltage-related triggering, polarized, capable of switching parallel loads
- Approvals / Marks (partly pending, details see "Approvals and marks" on page 14)



¹⁾ Only for devices with 1 c/o (SPDT) contact

Benefits

Direct reading scales ①

Direct setting of the time delay without any additional calculation provides accurate time delay adjustment.

LEDs for status indication ②

All actual operational states are displayed by front-face LEDs, thus simplifying commissioning and troubleshooting.

Switching currents

The CT-D range timers allow an output load of up to 6 A on devices with 1 c/o contact and up to 5 A on devices with 2 c/o contacts.

Connection terminals ③

Wide terminal spacing allows connection of wires: 2 x 1.5 mm² (2 x 16 AWG) with wire end ferrules or 2 x 2.5 mm² (2 x 14 AWG) without ferrules.

Width 17.5 mm ④

With their width of 17.5 mm only, the CT-D range timers are ideally suited for installation in distribution panels.

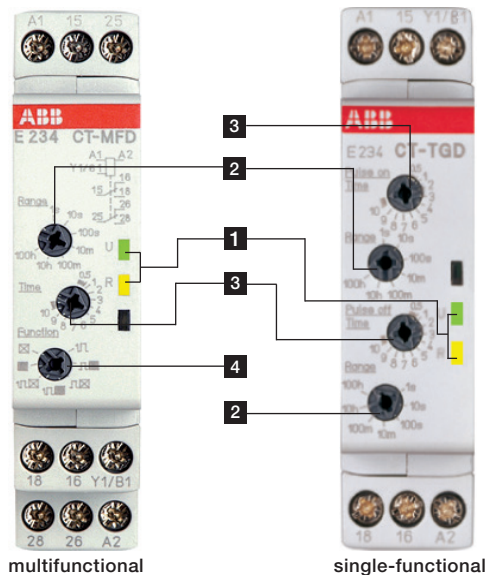

Operating controls

① LEDs for status indication

- U - green LED: control supply voltage applied
- timing
- R, R1, R2 - yellow LED: output relay energized

② Time range adjustment

③ Fine adjustment of the time delay

④ Preselection of the timing function

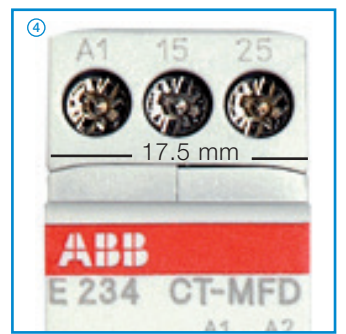
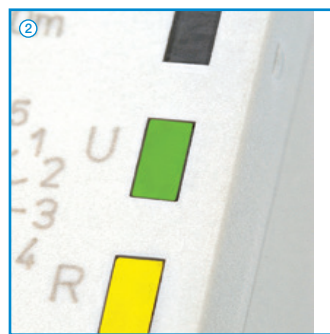

CT-D range

Ordering details



CT-MFD.12



CT-ERD.22

Description

The CT-D range in MDRC design with a width of only 17.5 mm fits into all domestic installation and distribution panels.

The CT-D range represents a link between industry and the installation types. For maximum flexibility in operation, 10 single-function as well as 2 multifunction devices with 7 timing functions are available. The devices offer 4 or 7 time ranges from 0.05 seconds up to 100 hours. Their wide input range allows the use in applications worldwide.

Ordering details

Timing function	Rated control supply voltage	Time ranges	Control input	Output	Type	Order code	Price	Weight
							1 pce	(1 pce) kg (lb)
Multi ¹⁾	24-240 V AC 24-48 V DC	7 (0.05 s - 100 h)	■	1 c/o	CT-MFD.12	1SVR500020R0000		0.060 (0.132)
Multi ¹⁾	12-240 V AC/DC	7 (0.05 s - 100 h)	■	2 c/o	CT-MFD.21	1SVR500020R1100		0.065 (0.143)
ON-delay			-	1 c/o	CT-ERD.12	1SVR500100R0000		0.060 (0.132)
			-	2 c/o	CT-ERD.22	1SVR500100R0100		0.065 (0.143)
OFF-delay		7 (0.05 s - 100 h)	■	1 c/o	CT-AHD.12	1SVR500110R0000		0.060 (0.132)
			■	2 c/o	CT-AHD.22	1SVR500110R0100		0.065 (0.143)
Impulse-ON	24-240 V AC 24-48 V DC		-		CT-VWD.12	1SVR500130R0000		0.060 (0.132)
Flasher starting with ON			-	1 c/o	CT-EBD.12	1SVR500150R0000		
Pulse generator		2x7 (0.05 s - 100 h)	■		CT-TGD.12 ²⁾	1SVR500160R0000		0.060 (0.132)
			■	2 c/o	CT-TGD.22 ²⁾	1SVR500160R0100		0.065 (0.143)
Star-delta change-over		4 (0.05 s - 10 min)	-		CT-SDD.22 ³⁾	1SVR500211R0100		0.065 (0.143)
			-	2 c/o	CT-SAD.22 ⁴⁾	1SVR500210R0100		

¹⁾ Functions: ON-delay, OFF-delay with auxiliary voltage, Impulse-ON, Impulse-OFF with auxiliary voltage, Flasher starting with ON, Flasher starting with OFF, Pulse former

²⁾ ON and OFF times adjustable independently: 2 x 7 time ranges 0.05 s - 100 h

³⁾ Transition time 50 ms fixed

⁴⁾ Transition time adjustable

■ Control input with voltage-related triggering
- no triggering

Synonyms

used expression	alternative expression(s)	used expression	alternative expression(s)
1 c/o contact	SPDT	voltage-related	wet / non-floating
2 c/o contacts	DPDT	volt-free	dry / floating



Further documentation CT-D electronic timers on www.abb.com

CT-D range

Connection diagrams

1

CT-MFD.21

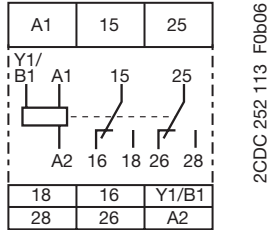

A1-A2 Supply: 12-240 V AC/DC
 A1-Y1/B1 Control input
 15-16/18 1. c/o contact
 25-26/28 2. c/o contact

CT-MFD.12

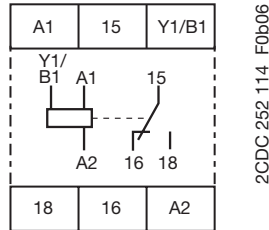

A1-A2 Supply: 24-48 V DC or 24-240 V AC
 A1-Y1/B1 Control input
 15-16/18 1. c/o contact

CT-ERD.22

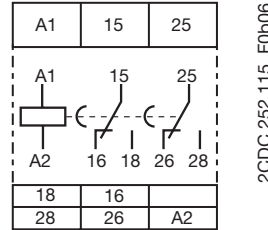

A1-A2 Supply: 24-48 V DC or 24-240 V AC
 15-16/18 1. c/o contact
 25-26/28 2. c/o contact

CT-ERD.12

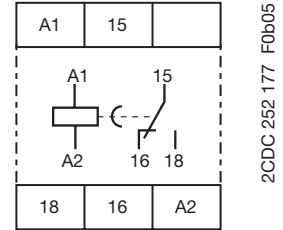

A1-A2 Supply: 24-48 V DC or 24-240 V AC
 15-16/18 1. c/o contact

CT-AHD.22

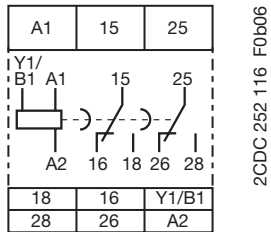

A1-A2 Supply: 24-48 V DC or 24-240 V AC
 A1-Y1/B1 Control input
 15-16/18 1. c/o contact
 25-26/28 2. c/o contact

CT-AHD.12

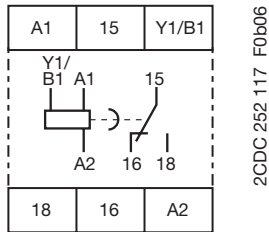

A1-A2 Supply: 24-48 V DC or 24-240 V AC
 A1-Y1/B1 Control input
 15-16/18 1. c/o contact

CT-VWD.12

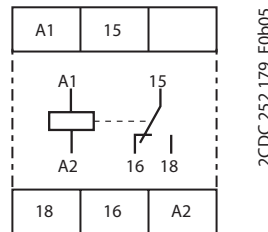

A1-A2 Supply: 24-48 V DC or 24-240 V AC
 15-16/18 1. c/o contact

CT-EBD.12

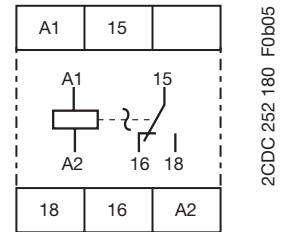

A1-A2 Supply: 24-48 V DC or 24-240 V AC
 15-16/18 1. c/o contact

CT-TGD.22

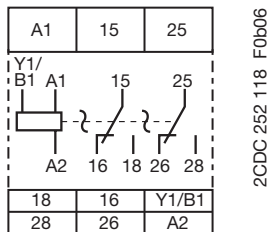

A1-A2 Supply: 24-48 V DC or 24-240 V AC
 A1-Y1/B1 Control input
 15-16/18 1. c/o contact
 25-26/28 2. c/o contact

CT-TGD.12

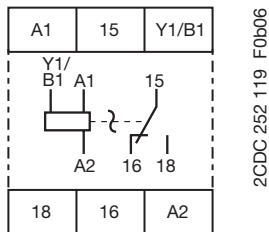

A1-A2 Supply: 24-48 V DC or 24-240 V AC
 A1-Y1/B1 Control input
 15-16/18 1. c/o contact

CT-SDD.22

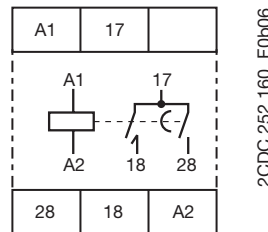

A1-A2 Supply: 24-48 V DC or 24-240 V AC
 17-18 1. n/o contact (star contactor)
 17-28 2. n/o contact (delta contactor)

CT-SAD.22

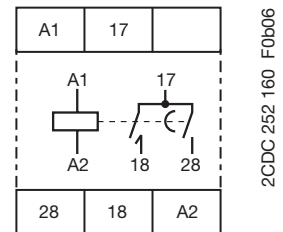



A1-A2 Supply: 24-48 V DC or 24-240 V AC
 17-18 1. n/o contact (star contactor)
 17-28 2. n/o contact (delta contactor)

CT-D range

Technical data

Data at $T_a = 25\text{ °C}$ and rated values, unless otherwise indicated

	CT-D with 1 c/o contact	CT-D with 2 c/o contacts	CT-MFD.21
Input circuit - Supply circuit			
Rated control supply voltage U_s	24-240 V AC / 24-48 V DC		12-240 V AC/DC
Rated control supply voltage U_s tolerance	-15...+10 %		
Rated frequency	DC or 50/60 Hz		
Frequency range AC	47-63 Hz		
Typical current / power consumption	see data sheet		
Power failure buffering time	min. 20 ms		
Release voltage	> 10 % of the minimum rated control supply voltage U_s		
Input circuit - Control circuit			
Control input, control function	A1-Y1/B1	start timing external	
Kind of triggering		voltage-related triggering	
Resistance to reverse polarity		yes	
Parallel load / polarized		yes / yes	
Maximum cable length to the control inputs		50 m - 100 pF/m	
Minimum control pulse length		20 ms	
Control voltage potential		see rated control supply voltage	
Current consumption of the control input		see data sheet	
Timing circuit			
Time ranges	7 time ranges 0.05 s - 100 h	1.) 0.05-1 s 2.) 0.5-10 s 3.) 5-100 s 4.) 0.5-10 min 5.) 5-100 min 6.) 0.5-10 h 7.) 5-100 h	
	4 time ranges 0.05 s - 10 min (CT-SDD, CT-SAD)	1.) 0.05-1 s 2.) 0.5-10 s 3.) 5-100 s 4.) 0.5-10 min	
Recovery time		< 50 ms	
Accuracy within the rated control supply voltage tolerance		$\Delta t < 0.005\% / V$	
Accuracy within the temperature range		$\Delta t < 0.06\% / \text{°C}$	
Repeat accuracy (constant parameters)		$\Delta t < \pm 0.5\%$	
Setting accuracy of time delay	IEC/EN 61812-1	$\pm 10\%$ of full-scale value	
Star-delta transition time	CT-SDD / CT-SAD	fixed 50 ms / adjustable: 20 ms, 30 ms, 40 ms, 50 ms, 60 ms, 80 ms or 100 ms	
Star-delta transition time tolerance	CT-SDD / CT-SAD	$\pm 3\text{ ms}$	
Indication of operational states			
Control supply voltage / timing	U: green LED	 : control supply voltage applied  : timing	
Relay energized (1 c/o contact / 2 c/o contacts or inst. contact)	R: yellow LED	 : output relay energized	
Operating elements and controls			
Adjustment of the time range		front-face rotary switch, direct reading scales	
Fine adjustment of the time value		front-face potentiometer	
Preselection of the timing function at multifunction devices		front-face rotary switch, direct reading scales	
Adjustment of the transition time	CT-SAD	front-face potentiometer	
Output circuit			
Kind of output	15-16/18 15-16/18; 25-26/28 17-18; 17-28	Relay, 1 c/o contact - -	- Relay, 2 c/o contacts Relay, 2 n/o contacts (CT-SDD, CT-SAD)
Contact material		AgNi alloy, Cd free	
Rated operational voltage U_o		250 V	
Minimum switching voltage / minimum switching current		12 V / 100 mA	
Maximum switching voltage / maximum switching current		250 V AC / 6 A	
Rated operational current I_o (IEC/EN 60947-5-1)	AC-12 (resistive) at 230 V AC-15 (inductive) at 230 V DC-12 (resistive) at 24 V DC-13 (inductive) at 24 V	6 A 3 A 6 A 2 A	5 A 3 A 5 A 2 A
AC rating (UL 508)	utilization category (Control Circuit Rating Code) max. rated operational voltage	B 300 300 V AC	n/o: B 300 n/c: C 300
	Maximum continuous thermal current at B300	5 A	n/o: 5 A
	Maximum continuous thermal current at C300	-	n/c: 2.5 A
	max. making/breaking apparent power at B300	3600 VA / 360 VA	n/o: 3600/360 VA
	max. making/breaking apparent power at C300	-	n/c: 1800/180 VA
Mechanical lifetime		30 x 10 ⁶ switching cycles	
Electrical lifetime		0.1 x 10 ⁶ switching cycles	
Max. fuse rating to achieve short-circuit protection (IEC/EN 60947-5-1)	n/c contact n/o contact	6 A fast-acting 10 A fast-acting	6 A fast-acting

CT-D range

Technical data

1

		CT-D with 1 c/o contact	CT-D with 2 c/o contacts	CT-MFD.21
General data				
Mean time between failures (MTBF)		on request		
Duty time		100%		
Dimensions (W x H x D)		17.5 x 70 x 58 mm (0.69 x 2.76 x 2.28 in)	17.5 x 80 x 58 mm (0.69 x 3.15 x 2.28 in)	
Weight		see ordering details		
Mounting		DIN rail (IEC/EN 60715), snap-mounting without any tool		
Mounting position		any		
Minimum distance to other units	horizontal / vertical	no / no		
Degree of protection	housing / terminals	IP50 / IP20		
Electrical connection				
Wire size	fine-strand with(out) wire end ferrule	2 x 0.5-1.5 mm ² (2 x 20-16 AWG) 1 x 0.5-2.5 mm ² (1 x 20-14 AWG)		
	rigid	2 x 0.5-1.5 mm ² (2 x 20-16 AWG) 1 x 0.5-4 mm ² (1 x 20-12 AWG)		
Stripping length		7 mm (0.28 in)		
Tightening torque		0.5-0.8 Nm (4.43-7.08 lb.in)		
Environmental data				
Ambient temperature range	operation / storage	-20 ... +60 °C / -40 ... +85 °C		
Climatic class	IEC/EN 60068-2-30	3K3		
Relative humidity range		25-85%		
Shock (half-sine)	IEC/EN 60068-2-27	150 m/s ² , 11 ms		
Isolation data				
Rated impulse withstand voltage U _{imp} between all isolated circuits	IEC/EN 60664-1	type test: 4 kV; 1.2/50 µs		
Pollution category	IEC/EN 60664-1	3		
Overvoltage category	IEC/EN 60664-1	III		
Rated insulation voltage U _i	input circuit / output circuit	300 V		
	output circuit 1 / output circuit 2	not available	300 V	300 V
Basic insulation (IEC/EN 61140)	input circuit / output circuit	300 V		
Protective separation (IEC/EN 61140, EN 50178)	input circuit / output circuit	250 V		
Power-frequency withstand voltage test (test voltage)	between all isolated circuits	routine test: 2.5 kV; 50 Hz; 1 s type test: 2.5 kV; 50 Hz; 60 s		
Standards				
Product standard		IEC/EN 61812-1		
Low Voltage Directive		2006/95/EC		
EMC Directive		2004/108/EC		
RoHS Directive		2011/65/EC		
Electromagnetic compatibility				
Interference immunity to		IEC/EN 61000-6-1, IEC/EN 61000-6-2		
electrostatic discharge	IEC/EN 61000-4-2	Level 3 (6 kV / 8 kV)		
radiated, radio-frequency, electromagnetic field	IEC/EN 61000-4-3	Level 3 (10 V / m)		
electrical fast transient / burst	IEC/EN 61000-4-4	Level 3 (2 kV / 5 kHz)		
surge	IEC/EN 61000-4-5	Level 4 (2 kV L-L)		
conducted disturbances, induced by radio-frequency fields	IEC/EN 61000-4-6	Level 3 (10 V)		
Interference emission		IEC/EN 61000-6-3, IEC/EN 61000-6-4		
high-frequency radiated	IEC/CISPR 22, EN 55022	Class B		
high-frequency conducted	IEC/CISPR 22, EN 55022	Class B		

Product certifications and declarations see "Approvals and marks" on page 14.

CT-D range

Technical diagrams, Wiring notes, Dimensional drawings

Technical diagrams

Load limit curves

AC load (resistive)

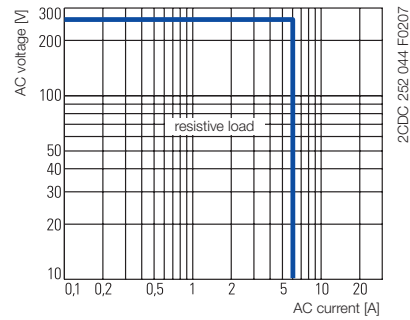

CT-D.1x

DC load (resistive)

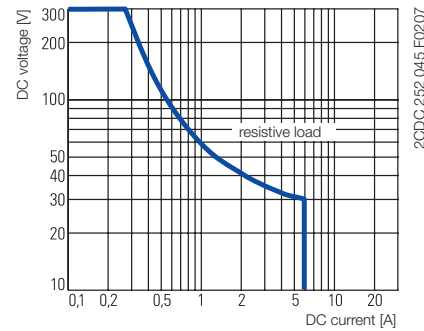

CT-D.1x

Derating factor F for inductive AC load

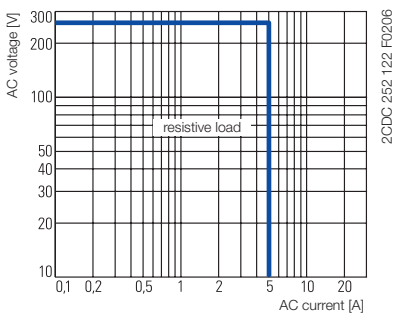
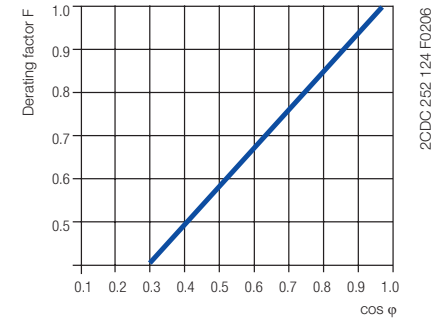

CT-D.2x

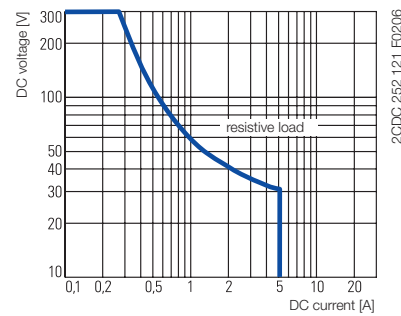

CT-D.2x

Contact lifetime

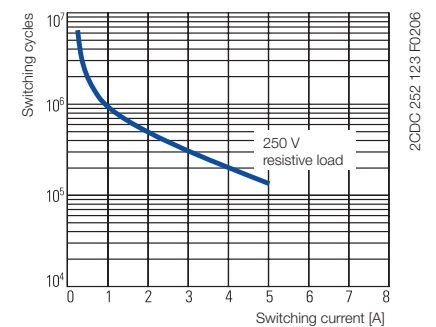

Wiring notes for devices with control input

A parallel load to the control input is possible

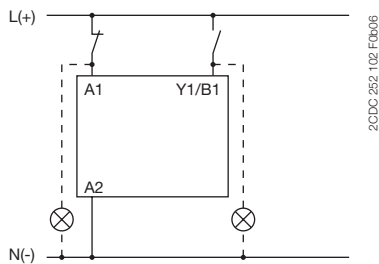

Dimensional drawings

dimensions in mm

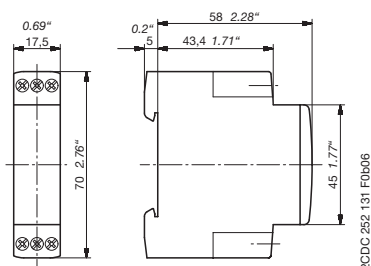

CT-D devices with 1 c/o contact or 2 n/o contacts

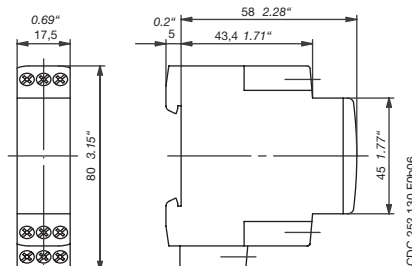

CT-D devices with 2 c/o contacts

CT-E range

Product group picture

1



CT-E range

Table of contents

CT-E Range

CT-E range	24
Benefits and advantages	25
Ordering details	26
Connection diagrams	28
Connection diagrams, Technical diagrams	29
Technical data	30
Wiring notes, Dimensional drawings	32

CT-E range

Benefits and advantages

1

Characteristics

- Diversity:
 - 2 multifunction timers
 - 56 single-function timers
- Control supply voltages:
 - Dual range: 24 V AC/DC
 - Single range: 110-130 V AC, 220-240 V AC
 - Wide range: 24-240 V AC/DC (CT-MFE)
- Time ranges
 - 5 single ranges: 0.05-1 s, 0.1-10 s, 0.3-30 s, 3-300 s, 0.3-30 min
 - 8 time ranges: 0.05 s - 100 h (CT-MFE)
- Devices with 1 c/o (SPDT) contact (250 V / 4 A) or solid-state output for high switching frequencies (thyristor 0.8 A)
- Approvals / Marks (details see "Approvals and marks" on page 14)
 -

Benefits

Direct reading scales ①

Direct setting of the time delay without any additional calculation provides accurate time delay adjustment.

LEDs for status indication ②

All actual operational states are displayed by front-face LEDs, thus simplifying commissioning and troubleshooting.

Connection screws in M3 (PoziDrive 1) ③

Easy and fast tightening and release of the connection screws with pozidrive, pan- or crosshead screwdriver.

Solid-state output ④

Devices with solid-state output are the perfect solution for high operation cycles.

Synonyms

used expression	alternative expression(s)	used expression	alternative expression(s)
1 c/o contact	SPDT	voltage-related	wet / non-floating
2 c/o contacts	DPDT	volt-free	dry / floating

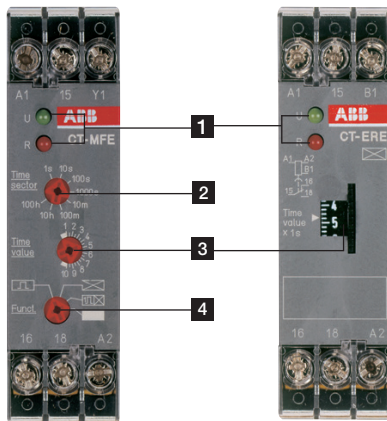

Operating controls

① LEDs for status indication

U - green LED: control supply voltage applied
 R2: red LED: output relay energized

② Time range adjustment (only multifunctional devices)

③ Fine adjustment of the time delay

④ Preselection of the timing function (only multifunctional devices)

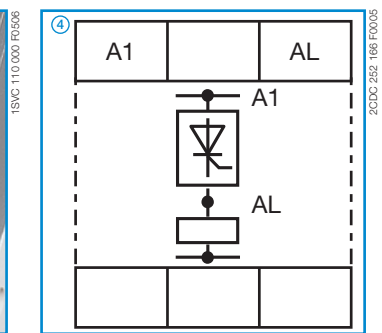
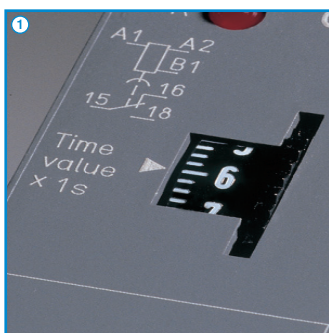

CT-E range

Ordering details



CT-MFE



CT-AHE

Description

The CT-E range with its excellent price/performance ratio offers an ideal solution for serial applications. 56 single-function devices with 5 different time ranges as well as 2 multifunction timers with 6 functions and 8 time ranges offer the highest possible flexibility for almost every application. For high operating cycles, contact-free CT-E timers with solid-state output are available.

Ordering details

Timing function	Rated control supply voltage	Time ranges	Control Input	Output	Type	Order code	Price 1 pce	Weight (1 pce) kg (lb)
Multi ¹⁾	24-240 V AC/DC	8 (0.05 s - 100 h)	■	1 c/o	CT-MFE	1SVR550029R8100		0.08 (0.18)
		0.1-10 s				1SVR550107R1100		
ON-delay	24 V AC/DC, 220-240 V AC	0.3-30 s	-	1 c/o	CT-ERE	1SVR550107R4100		0.08 (0.18)
		3-300 s				1SVR550107R2100		
		0.3-30 min				1SVR550107R5100		
	110-130 V AC	0.1-10 s			1SVR550100R1100			
		0.3-30 s			1SVR550100R4100			
		3-300 s			1SVR550100R2100			
OFF-delay	24 V AC/DC	0.1-10 s		1 c/o	CT-AHE	1SVR550118R1100		0.08 (0.18)
		0.3-30 s				1SVR550118R4100		
		3-300 s				1SVR550118R2100		
	110-130 V AC	0.1-10 s	■		1SVR550110R1100			
		0.3-30 s			1SVR550110R4100			
		3-300 s			1SVR550110R2100			
OFF-delay ²⁾	220-240 V AC	0.1-10 s		1 c/o	CT-ARE	1SVR550111R1100		0.08 (0.18)
		0.3-30 s				1SVR550111R4100		
		3-300 s				1SVR550111R2100		
	24 V AC/DC, 220-240 V AC	0.1-10 s			1SVR550127R1100			
		0.3-30 s			1SVR550127R4100			
		3-300 s			1SVR550127R2100			
Impulse-ON	110-130 V AC	0.1-10 s		1 c/o	CT-VWE	1SVR550137R1100		0.08 (0.18)
		0.3-30 s				1SVR550137R4100		
		3-300 s				1SVR550137R2100		
	24 V AC/DC	0.1-10 s			1SVR550130R1100			
		0.3-30 s			1SVR550130R4100			
		3-300 s			1SVR550130R2100			
Impulse-OFF ²⁾	110-130 V AC	0.05-1 s		1 c/o	CT-AWE	1SVR550158R3100		0.08 (0.18)
		220-240 V AC				1SVR550150R3100		
							1SVR550151R3100	

1) Functions: ON-delay, OFF-delay with auxiliary voltage, Impulse-ON, Flasher starting with ON, Flasher starting with OFF, Pulse former

2) without auxiliary voltage, True Off-delay timer

■ Control input with voltage-related triggering
- no triggering



Further documentation CT-E electronic timers on www.abb.com

CT-E range

Ordering details

1



CT-MFE



CT-AHE

Description

The CT-E range with its excellent price/performance ratio offers an ideal solution for serial applications. 56 single-function devices with 5 different time ranges as well as 2 multifunction timers with 6 functions and 8 time ranges offer the highest possible flexibility for almost every application. For high operating cycles, contact-free CT-E timers with solid-state output are available.

Ordering details

Timing function	Rated control supply voltage	Time ranges	Control Input	Output	Type	Order code	Price 1 pce	Weight (1 pce) kg (lb)
Multi ¹⁾	24-240 V AC/DC	8 (0.05 s - 100 h)	■	1 c/o	CT-MFE	1SVR550029R8100		0.08 (0.18)
ON-delay	24 V AC/DC, 220-240 V AC	0.1-10 s	-	1 c/o	CT-ERE	1SVR550107R1100		0.08 (0.18)
		0.3-30 s	-			1SVR550107R4100		
		3-300 s	-			1SVR550107R2100		
	0.3-30 min	-	1SVR550107R5100					
	110-130 V AC	0.1-10 s	-			1SVR550100R1100		
		0.3-30 s	-			1SVR550100R4100		
3-300 s		-	1SVR550100R2100					
OFF-delay	24 V AC/DC	0.1-10 s	-	1 c/o	CT-AHE	1SVR550118R1100		0.08 (0.18)
		0.3-30 s	-			1SVR550118R4100		
		3-300 s	-			1SVR550118R2100		
	110-130 V AC	0.1-10 s	-			1SVR550110R1100		
		0.3-30 s	■			1SVR550110R4100		
		3-300 s	-			1SVR550110R2100		
220-240 V AC	0.1-10 s	-	1SVR550111R1100					
	0.3-30 s	-	1SVR550111R4100					
	3-300 s	-	1SVR550111R2100					
OFF-delay ²⁾	24 V AC/DC, 220-240 V AC	0.1-10 s	-	1 c/o	CT-ARE	1SVR550127R1100		0.08 (0.18)
		0.3-30 s	-			1SVR550127R4100		
	110-130 V AC	0.1-10 s	-			1SVR550120R1100		
Impulse-ON	24 V AC/DC, 220-240 V AC	0.1-10 s	-	1 c/o	CT-VWE	1SVR550137R1100		0.08 (0.18)
		0.3-30 s	-			1SVR550137R4100		
		3-300 s	-			1SVR550137R2100		
	110-130 V AC	0.1-10 s	-			1SVR550130R1100		
		0.3-30 s	-			1SVR550130R4100		
Impulse-OFF ²⁾	24 V AC/DC	-	-	1 c/o	CT-AWE	1SVR550158R3100		0.08 (0.18)
	110-130 V AC	0.05-1 s	-			1SVR550150R3100		
	220-240 V AC	-	-			1SVR550151R3100		

¹⁾ Functions: ON-delay, OFF-delay with auxiliary voltage, Impulse-ON, Flasher starting with ON, Flasher starting with OFF, Pulse former

²⁾ without auxiliary voltage, True Off-delay timer

■ Control input with voltage-related triggering
- no triggering



Further documentation CT-E electronic timers on www.abb.com

CT-E range

Connection diagrams

CT-MFE

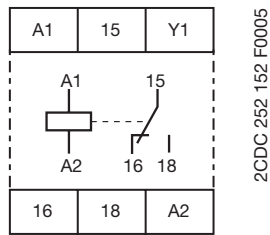

A1-A2 Supply: 24-240 V AC/DC
 A1-Y1 Control input
 15-16/18 c/o contact

CT-ERE

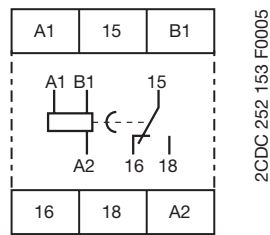

A1-A2 Supply: 220-240 V AC or 110-130 V AC
 A1-B1 Supply: 24 V AC/DC
 15-16/18 c/o contact

CT-AHE¹⁾

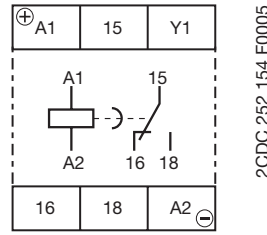

A1-A2 Supply: 24 V AC/DC or 110-240 V AC or 220-240 V AC
 A1-Y1 Control input
 15-16/18 c/o contact

CT-ARE

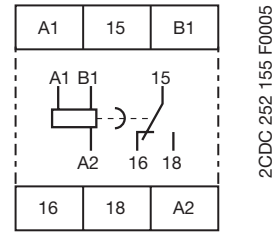

A1-A2 Supply: 220-240 V AC or 110-130 V AC
 A1-B1 Supply: 24 V AC/DC
 15-16/18 c/o contact

CT-VWE

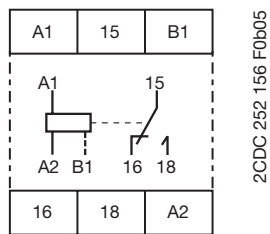

A1-A2 Supply: 220-240 V AC or 110-130 V AC
 A1-B1 Supply: 24 V AC/DC
 15-16/18 c/o contact

CT-AWE

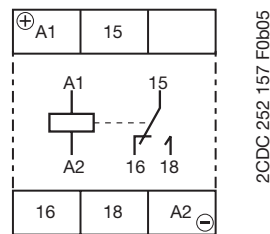

A1(+) - A2(-) Supply: 24 V AC/DC or 110-240 V AC or 220-240 V AC
 15-16/18 c/o contact

CT-AWE¹⁾

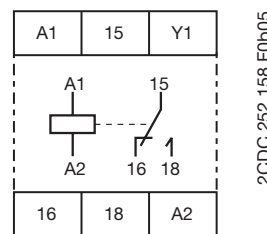

A1-A2 Supply: 24 V AC/DC or 110-240 V AC or 220-240 V AC
 A1-Y1 Control input
 15-16/18 c/o contact

CT-EBE

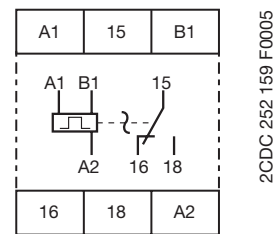

A1-A2 Supply: 220-240 V AC or 110-130 V AC
 A1-B1 Supply: 24 V AC/DC
 15-16/18 c/o contact

CT-YDE

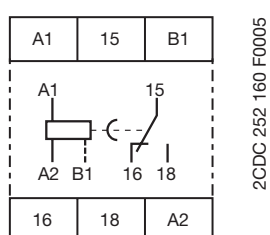

A1-A2 Supply: 220-240 V AC or 110-130 V AC
 A1-B1 Supply: 24 V AC/DC
 15-16/18 c/o contact

CT-SDE

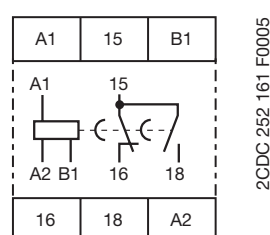

Device: 1SVR 550 217 R4100
 A1-A2 Supply: 220-240 V AC
 A1-B1 Supply: 24 V AC/DC
 15-16 n/c contact
 15-18 n/o contact with common contact

CT-SDE

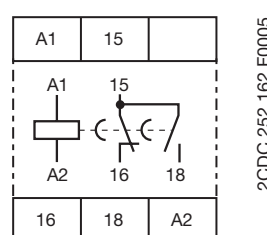

Devices: 1SVR 550 210 R4100, 1SVR 550 212 R4100
 A1-A2 Supply: 110-130 V AC or 380-415 V AC
 15-16 n/c contact
 15-18 n/o contact with common contact

CT-MKE

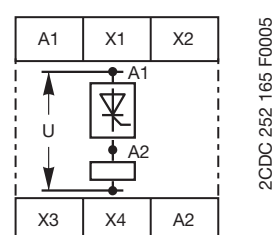

A1-A2 Supply: 24-240 V AC/DC
 A1-A2 Thyristor
 X1-X4 Timing function adjustment
 X2-X4 Timing function adjustment
 X3-X4 Time range adjustment
 (Details see function diagrams)

¹⁾ "Wiring notes, Dimensional drawings" on page 32

CT-E range

Connection diagrams, Technical diagrams

1

CT-EKE

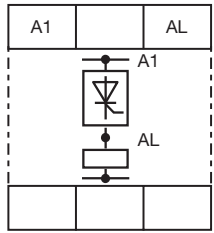

2CDC 252 166 F0005

A1-AL Supply: 24-240 V AC/DC
A1-AL Thyristor

CT-AKE

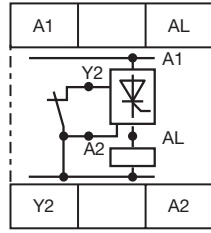

2CDC 252 167 F0005

A1-AL Supply: 24-240 V AC
A1-AL Thyristor
Y2-A2 Control input

Technical diagrams

Load limit curves AC load (resistive)

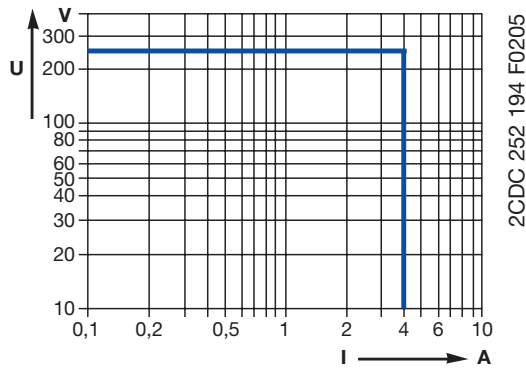

DC load (resistive)

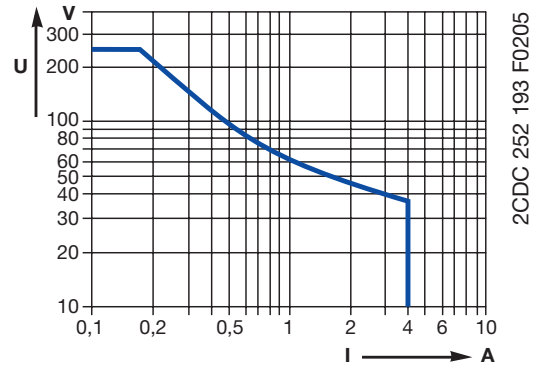

220 V 50 Hz AC1
360 cycles/h

Derating factor F for inductive AC load

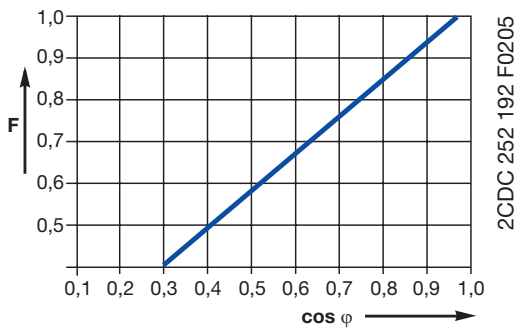

Contact lifetime

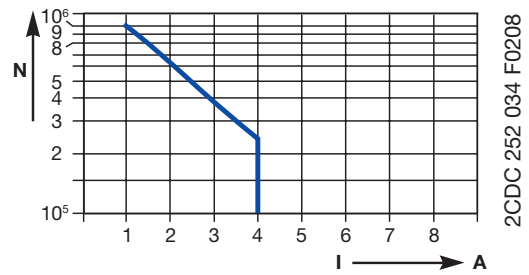

CT-E range

Technical data

Technical data

Data at $T_a = 25\text{ °C}$ and rated values, unless otherwise indicated

		CT-E (relays)	CT-E (solid-state)
Input circuit - Supply circuit			
Rated control supply voltage U_s	A1-A2, A1-AL	24-240 V AC/DC	
	A1-A2, A1-AL	24-240 V AC	
	A1-A2	110-130 V AC	-
	A1-A2	220-240 V AC	-
	A1-A2	380-415 V AC	-
	A1-B1	24 V AC/DC	-
Rated control supply voltage U_s tolerance		-15...+10 %	
Rated frequency	AC/DC versions	DC or 50/60 Hz	
	AC versions	50/60 Hz	
Typical current / power consumption	24-240 V AC/DC, 24-240 V AC	approx. 1.0-2.0 VA/W	
	110-130 V AC, 220-240 V AC	approx. 2.0 VA	-
	380-415 V AC	approx. 3.0 VA	-
	24 V AC/DC	approx. 1.0 VA/W	-
Minimum energizing time	CT-ARE, CT-AWE w/o aux. voltage	200 ms	-
Current consumption while timing			≤ 2 mA (24-60 V AC/DC) ≤ 8 mA (60-240 V AC/DC) (CT-AKE only AC)
Input circuit - Control circuit			
Kind of triggering		voltage-related triggering	-
Control input, Control function	A1-Y1	start timing external	-
Parallel load / polarized		no / yes ¹⁾	-
Minimum control pulse length		20 ms	-
Control voltage potential		see rated control supply voltage	-
Timing circuit			
Time ranges	1 of 5 time ranges per single-function device 8 time ranges 0.05 s - 100 h (CT-MFE)	0.05-1 s / 0.1-10 s / 0.3-30 s / 3-300 s / 0.3-30 min 1.) 0.05-1 s 2.) 0.5-10 s 3.) 5-100 s 4.) 50-1000 s 5.) 0.5-10 min 6.) 5-100 min 7.) 0.5-10 h 8.) 5-100 h	-
	2 time ranges 0.1-300 s (CT-MKE)	-	1.) 0.1-10 s 2.) 3-300 s
Recovery time		<50 ms CT-ARE: <200 ms CT-AWE, CT-SDE: <400 ms CT-YDE: <500 ms	CT-EKE: <50 ms CT-MKE: <100 ms CT-AKE: <300 ms
Accuracy within the rated control supply voltage tolerance		$\Delta t < 0.5\% / V$	
Accuracy within the temperature range		$\Delta t < 0.1\% / \text{°C}$ CT-MFE: $\Delta t < 0.06\% / \text{°C}$	-
Repeat accuracy (constant parameters)		$\Delta t < 1\%$	-
Star-delta transition time	CT-YDE / CT-SDE	50 ms / 30 ms	-
Output circuit			
Kind of output	15-16/18 CT-SDE: 15-16, 15-18	Relay, 1 c/o contact 1 n/c, 1 n/o contact with common contact	-
Contact material	A1-A2, A1-AL	-	Thyristor
Rated operational voltage U_o	IEC/EN 60947-1	AgCdO 250 V	-
Maximum switching voltage		250 V AC, 250 V DC	
Rated operational current I_o (IEC/EN 60947-5-1)	AC-12 (resistive) at 230 V AC-15 (inductive) at 230 V DC-12 (resistive) at 24 V DC-13 (inductive) at 24 V	4 A 3 A 4 A 2 A	- - - -

¹⁾ CT-MFE: yes / no

CT-E range

Technical data

1

		CT-E (relays)	CT-E (solid-state)
AC rating (UL 508)	Utilization category (Control Circuit Rating Code)	B 300	-
	max. rated operational voltage	300 V AC	-
	Maximum continuous thermal current at B300	5 A	-
	max. making/breaking apparent power at B300	3600 VA / 360 VA	-
Mechanical lifetime		30 x 10 ⁶ switching cycles	-
Electrical lifetime	at AC-12, 230 V, 4 A	0.1 x 10 ⁶ switching cycles	-
Max. fuse rating to achieve short-circuit protection (IEC/EN 60947-5-1)	n/c contact	10 A fast-acting, CT-ARE: 5 A	-
	n/o contact	10 A fast-acting, CT-ARE: 5 A	-
Minimum load current		-	CT-MKE: 20 mA CT-EKE, CT-AKE: 10 mA
Maximum load current		-	CT-MKE: 0.8 A at T _a = 20 °C CT-EKE, CT-AKE: 0.7 A
Load current reduction / Derating		-	10 mA/°C
Maximum surge current		-	CT-MKE: ≤ 20 A for t ≤ 20 ms CT-EKE, CT-AKE: ≤ 15 A
Voltage drop in connected state		-	≤ 3 V
Cable length between solid-state timer and connected load at 50 Hz and a cable capacity of 100 pF/m :	at 24 V AC	-	220 m / 22 nF
	at 42 V AC	-	100 m / 10 nF
	at 60 V AC	-	65 m / 6.5 nF
	at 110 V AC	-	50 m / 5 nF
	at 240 V AC	-	22 m / 2.2 nF
General data			
Duty time		100%	
Dimensions (W x H x D)		22.5 x 78 x 78.5 mm (0.886 x 3.07 x 3.09 in)	
Weight		approx. 80 g (0.176 lb)	
Mounting		DIN rail (IEC/EN 60715)	
Mounting position		any	
Minimum distance to other units	horizontal / vertical	no / no	
Degree of protection	housing / terminals	IP50 / IP20	
Electrical connection			
Wire size	fine-strand with wire end ferrule	2 x 0.75-1.5 mm ² (2 x 18-16 AWG)	
	fine-strand without wire end ferrule	2 x 1-1.5 mm ² (2 x 18-16 AWG)	
	rigid	2 x 0.75-1.5 mm ² (2 x 18-16 AWG)	
Stripping length		10 mm (0.39 in)	
Tightening torque		0.6-0.8 Nm (5.31-7.08 lb.in)	
Environmental data			
Ambient temperature ranges	operation / storage	-20...+60 °C / -40...+85 °C	
Damp heat	IEC/EN 60068-2-30	24 h cycle, 55 °C, 93 % rel., 96 h	
Operational reliability	IEC/EN 60068-2-6	6 g	
Mechanical resistance	IEC/EN 60068-2-6	10 g	
Isolation data			
Rated impulse withstand voltage U _{imp} between all isolated circuits	IEC/EN 60664-1	type test: 4 kV; 1.2/50 μs	-
Pollution category	IEC/EN 60664-1	3	
Overvoltage category	IEC/EN 60664-1	III	
Power-frequency withstand voltage (test voltage) between all isolated circuits		routine test: 2.5 kV; 50 Hz; 1 s type test: 2.5 kV; 50 Hz; 60 s	-
Basic insulation (IEC/EN 61140)	input circuit / output circuit	300 V	-
Rated insulation voltage U _i	input circuit / output circuit	300 V (supply up to 240 V) 500 V (supply up to 440 V)	-
Test voltage between all isolated circuits	routine test	2.5 kV, 50 Hz, 1 s	-
Standards			
Product standard		IEC 61812-1, EN 61812-1 + A11, DIN VDE 0435 Teil 2021	
Low Voltage Directive		2006/95/EC	
EMC Directive		2004/108/EC	
Electromagnetic compatibility			
Interference immunity to electrostatic discharge	IEC/EN 61000-4-2	IEC/EN 61000-6-2 Level 3 (6 kV / 8 kV)	
radiated, radio-frequency electromagnetic field	IEC/EN 61000-4-3	Level 3 (10 V/m)	
electrical fast transient / burst surge	IEC/EN 61000-4-4	Level 3 (2 kV / 5 kHz)	
conducted disturbances, induced by radio-frequency fields	IEC/EN 61000-4-5	Level 4 (2 kV L-L)	
	IEC/EN 61000-4-6	Level 3 (10 V)	
Interference emission		IEC/EN 61000-6-4	

Product certifications and declarations see "Approvals and marks" on page 14.

CT-E range

Wiring notes, Dimensional drawings

Wiring notes

for single-function devices with control contact (CT-AHE, CT-AWE with auxiliary voltage)

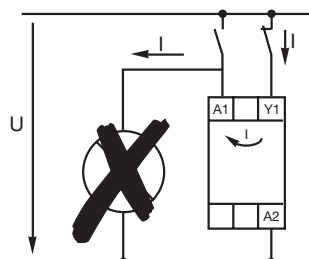

2CDC 252 200 F0b05

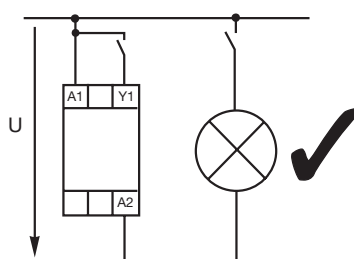

2CDC 252 199 F0b05

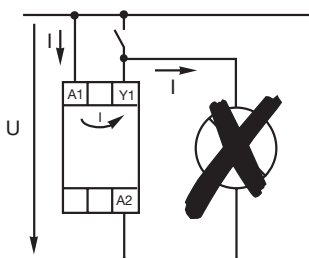

2CDC 252 198 F0b05

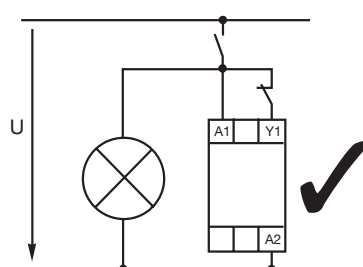

2CDC 252 201 F0b05

Dimensional drawing Dimensions in mm

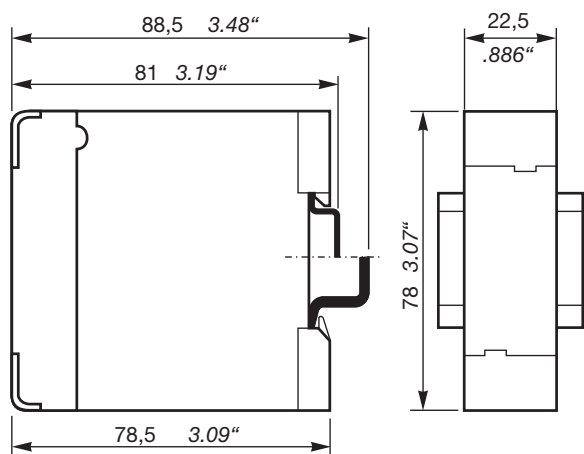

2CDC 252 189 F0b05

CT-S range

Product group picture

1



CT-S range

Table of contents

CT-S Range

CT-S range	34
Benefits and advantages	35
Ordering details - multifunctional	37
Ordering details - singlefunctional	38
Ordering details - Accessories	39
Connection diagrams	40
Technical data	42
Technical diagrams	45
Wiring notes, Dimensional drawings	46
Timing functions	47

CT-S range

Benefits and advantages

1

Characteristics

- Diversity:
 - 8 multifunction timers
 - 11 single-function timers
 - Control supply voltages:
 - Multi range: 24-48 V DC, 24-240 V AC
 - Wide range: 24-240 V AC/DC
 - Single range: 380-440 V AC
 - Innovative connection technology
 - Double-chamber cage connection terminals
 - Easy Connect Technology
 - Devices with:
 - 1 or 2 c/o (SPDT) contacts
 - 2nd c/o contact can be selected as instantaneous contact ¹⁾
 - Remote potentiometer connection ¹⁾
 - Control input with volt-free or voltage-related triggering e.g. to start timing, pause timing
 - Extended operating temperature range down to -40 °C ¹⁾
 - Sealable transparent cover for protection against unauthorized changes of time values
 - Integrated marker label
 - Approvals / Marks (partly pending, details see "Approvals and marks" on page 14)
 - 
- ¹⁾ selected devices

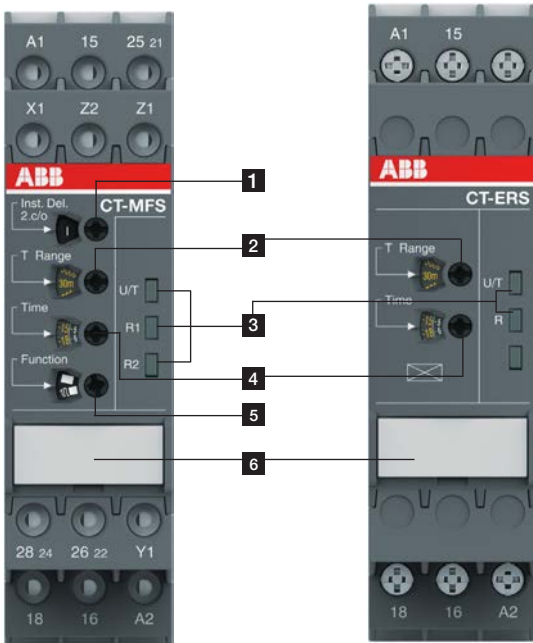

Operating controls



1 2nd contact as an instantaneous contact

2 Preselection of the time range

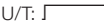
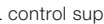
3 Indication of operational states

U/T:  control supply voltage applied /  timing
 R:  Output relay energized

4 Fine adjustment of time delay

5 Preselection of timing function

6 Marker label

CT-S range

Benefits and advantages

Easy Connect Technology ①

Tool-free wiring and excellent vibration resistance. Push-in terminals provide connection of wires up to $2 \times 0.5 - 1.5 \text{ mm}^2$ ($2 \times 20 - 16 \text{ AWG}$), rigid or fine-strand with or without wire end ferrules. The extended type designators for products with push-in terminals are indicated by a **P** following the extended type designator e.g. CT-xxS.xx**P**.

Double-chamber cage connection terminals ②

Double-chamber cage connection terminals provide connection of wires up to $2 \times 0.5-2.5 \text{ mm}^2$ ($2 \times 20-14 \text{ AWG}$) rigid or fine-strand, with or without wire end ferrules. Potential distribution does not require additional terminals. The extended type designators for products with double-chamber cage connection terminals are indicated by a **S** following the extended type designator e.g. CT-xxS.xx**S**.

Time range preselection and fine adjustment ③

Direct assignment of the preselected time range to the fine adjustment potentiometer scale by multicolor scales.

Higher utility class ④

The Easy Connect Technology provides excellent vibration resistance with gas tight push-in terminals – the right solution for harsh environment. Selected products of the electronic timers and measuring and monitoring relays comply to the latest rail standards NF F 16-101/102, EN 45545, EN 50155 and more standards which are relevant for railway applications. Find more information in the rail brochure 2CDC110084B0201.

LEDs for status indication ⑤

All actual operational states are displayed by front-face LEDs, thus simplifying commissioning and troubleshooting.

Integrated marker label ⑥

Integrated marker labels allow the product to be marked quickly and simply. No additional marker labels are required.

Sealable transparent cover ⑦

Protection against unauthorized changes of time and threshold values. Available as an accessory.

Snap-On housing ⑧

Tool-free DIN rail installation and deinstallation of the electronic timer.

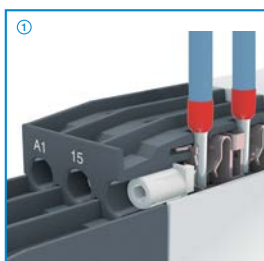

2CDC 253 025 F0011

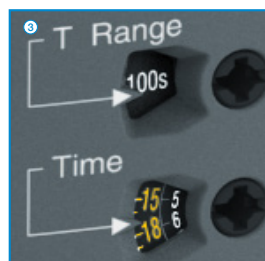

2CDC 253 035 F0011

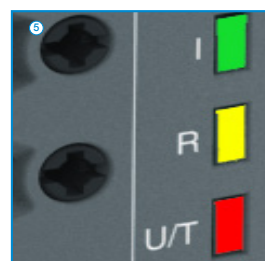

2CDC 252 006 F0012



2CDC 255 006 S0011

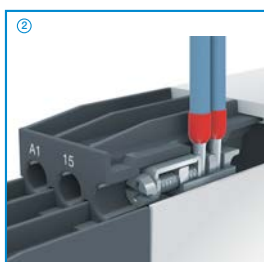

2CDC 253 025 F0011



2CDC 253 035 F0011



2CDC 253 007 F0012

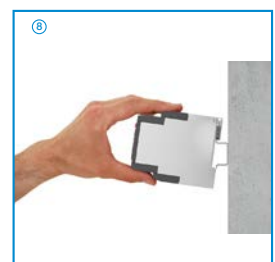

2CDC 253 013 F0013

CT-S range

Ordering details - multifunctional

1



CT-MVS.21P



CT-MBS.22P

Description

The high-performance CT-S range in ABB's new S-range housing offers two different types of connection terminals and is ideally suited for universal use. Two different connection technologies are available:

- Double-chamber cage connection terminals
- Easy Connect Technology

Accessories:

The CT-S range offers the possibility of using accessories such as a remote potentiometer to adjust the time delay or a sealable, transparent cover to protect against unauthorized changes of time and threshold values.

Ordering details

Timing function	Rated control supply voltage	Time ranges	Control input	Output	Type	Order code	Price	Weight
							1 pce	(1 pce) kg (lb)
Multi ⁵⁾	24- 240 V AC/DC	10 (0.05 s - 300 h)	■	2 c/o	CT-MVS.21S ^{1) 2) 3)}	1SVR730020R0200		0.148 (0.326)
					CT-MVS.21P ^{1) 2) 3)}	1SVR740020R0200		0.136 (0.30)
	24-48 V DC, 24-240 V AC	CT-MVS.22S			1SVR730020R3300		0.142 (0.313)	
		CT-MVS.22P			1SVR740020R3300		0.131 (0.289)	
		CT-MVS.23S			1SVR730021R2300		0.144 (0.317)	
		CT-MVS.23P			1SVR740021R2300		0.133 (0.293)	
380-440 V AC								
Multi ⁶⁾	24-48 V DC, 24-240 V AC	10 (0.05 s - 300 h)	■	1 c/o	CT-MVS.12S	1SVR730020R3100		0.107 (0.236)
					CT-MVS.12P	1SVR740020R3100		0.102 (0.225)
Multi ⁷⁾	24-48 V DC, 24-240 V AC	2x10 (0.05 s - 300 h)	■	2 c/o	CT-MXS.22S ^{*)}	1SVR730030R3300		0.142 (0.313)
					CT-MXS.22P ⁴⁾	1SVR740030R3300		0.131 (0.289)
Multi ⁸⁾	24- 240 V AC/DC	10 (0.05 s - 300 h)	□ / □	2 c/o	CT-MFS.21S ^{1) 2) 3)}	1SVR730010R0200		0.145 (0.32)
					CT-MFS.21P ^{1) 2) 3)}	1SVR740010R0200		0.133 (0.293)
	24-48 V DC, 24-240 V AC	10 (0.05 s - 300 h)			CT-MBS.22S ^{2) 3)}	1SVR730010R3200		0.14 (0.309)
					CT-MBS.22P ^{2) 3)}	1SVR740010R3200		0.129 (0.284)
Multi ⁹⁾	24-48 V DC, 24-240 V AC	10 (0.05 s - 300 h)	-	2 c/o	CT-WBS.22S	1SVR730040R3300		0.123 (0.271)
					CT-WBS.22P	1SVR740040R3300		0.115 (0.254)

- Control input with voltage-related triggering
- Control input with volt-free triggering
- / □ two control input with volt-free triggering
- no triggering
- S: screw connection
- P: push-in / easy connect

¹⁾ Extended temperature range -40 °C
²⁾ Remote potentiometer connection
³⁾ 2nd c/o contact selectable as instantaneous contact
⁴⁾ 2 remote potentiometer connections
⁵⁾ Functions: ON-delay, OFF-delay with auxiliary voltage, Impulse-ON, Impulse-OFF with auxiliary voltage, Symmetrical ON- and OFF-delay, Flasher starting with ON or OFF, Star-delta change-over with impulse, Pulse former, Accumulative ON-delay, ON/OFF-function
⁶⁾ Functions: ON-delay, OFF-delay with auxiliary voltage, Impulse-ON, Impulse-OFF with auxiliary voltage, Symmetrical ON- and OFF-delay, Flasher starting with ON or OFF, Pulse former, Accumulative ON-delay, ON/OFF-function
⁷⁾ Functions: Select function via DIP switches behind the marker label on the front of the unit, asymmetrical ON- and OFF-delay, Impulse-ON/OFF, Pulse generator starting with ON or OFF, Single pulse generator, ON/OFF-function
⁸⁾ Functions: ON-delay, OFF-delay with auxiliary voltage, Impulse-ON, Impulse-OFF with auxiliary voltage, Symmetrical ON- and OFF-delay, Flasher starting with ON, Flasher starting with OFF, Star-delta change-over with impulse, Pulse former, ON/OFF-function
⁹⁾ Functions: Flasher starting with ON, Flasher starting with OFF, Impulse-ON, ON-delay, fixed impulse with adjustable time delay, Adjustable impulse with fixed time delay, ON/OFF-function



Further documentation CT-S electronic timers on www.abb.com

CT-S range

Ordering details - singlefunctional



2CDC 251 030 V0011

CT-ERS.21P



2CDC 251 033 V0011

CT-AHS.22P



2CDC 251 040 V0011

CT-SDS.23P

Timing function	Rated control supply voltage	Time ranges	Control input	Output	Type	Order code	Price 1 pce	Weight (1 pce) kg (lb)		
ON-delay	24-240 V AC/DC	10 (0.05 s - 300 h)	-	2 c/o	CT-ERS.21S ¹⁾	1SVR730100R0300		0.13 (0.287)		
					CT-ERS.21P ¹⁾	1SVR740100R0300		0.121 (0.267)		
	CT-ERS.22S				1SVR730100R3300		0.121 (0.267)			
	CT-ERS.22P				1SVR740100R3300		0.113 (0.249)			
	CT-ERS.12S				1SVR730100R3100		0.106 (0.234)			
	CT-ERS.12P				1SVR740100R3100		0.101 (0.222)			
OFF-delay	24-240 V AC/DC	10 (0.05 s - 300 h)	■	2 c/o	CT-APS.21S ¹⁾	1SVR730180R0300		0.146 (0.322)		
					CT-APS.21P ¹⁾	1SVR740180R0300		0.125 (0.276)		
	CT-APS.22S				1SVR730180R3300		0.138 (0.304)			
	CT-APS.22P				1SVR740180R3300		0.127 (0.28)			
	CT-APS.12S				1SVR730180R3100		0.109 (0.24)			
	CT-APS.12P				1SVR740180R3100		0.103 (0.227)			
OFF-delay ⁵⁾	24-48 V DC, 24-240 V AC	10 (0.05 s - 300 h)	■	2 c/o	CT-AHS.22S	1SVR730110R3300		0.136 (0.30)		
					CT-AHS.22P	1SVR740110R3300		0.125 (0.276)		
	24-240 V AC/DC			7 (0.05 s - 10 min)	-	1 c/o	CT-ARS.11S	1SVR730120R3100		0.106 (0.234)
							CT-ARS.11P	1SVR740120R3100		0.10 (0.22)
Star-delta change-over ⁶⁾	24-48 V DC, 24-240 V AC	7 (0.05 s - 10 min)	-	2 c/o	CT-ARS.21S	1SVR730120R3300		0.124 (0.273)		
					CT-ARS.21P	1SVR740120R3300		0.115 (0.254)		
	380-440 V AC			CT-SDS.22S	1SVR730210R3300		0.114 (0.251)			
				CT-SDS.22P	1SVR740210R3300		0.108 (0.238)			
				2 n/o	CT-SDS.23S	1SVR730211R2300		0.118 (0.26)		
					CT-SDS.23P	1SVR740211R2300		0.112 (0.247)		

¹⁾ Extended temperature range -40 °C
²⁾ Remote potentiometer connection
³⁾ 2nd c/o contact selectable as instantaneous contact
⁴⁾ 2 remote potentiometer connections
⁵⁾ Without auxiliary voltage
⁶⁾ 50 ms transition time

■ Control input with voltage-related triggering
□ Control input with volt-free triggering
□ / □ two control input with volt-free triggering
- no triggering
S: screw connection
P: push-in / easy connect



Further documentation CT-S electronic timers on www.abb.com

CT-S range

Ordering details - Accessories

1



1SFC 151 138 V0001

MT-x50B

Remote potentiometer

50 k Ω \pm 20 % - 0.2 Ω , degree of protection IP66

Material	Diameter in mm	Type	Order code	Price 1 piece	Pack.- unit pieces	Weight 1 piece g / oz
Plastic, black	22.5	MT-150B	1SFA611410R1506		1	0.040
Plastic, chrome	22.5	MT-250B	1SFA611410R2506		1	0.040
Metal, chrome	22.5	MT-350B	1SFA611410R3506		1	0.048



Data sheet remote potentiometer



2CDC 252 042 F0009

30 mm adapters

30 mm adapter for attaching the potentiometer 22 mm in 30 mm mounting hole

Material	Type	Order code	Price 1 piece	Pack.- unit pieces	Weight 1 piece g / oz
Plastic, black	KA1-8029	1SFA616920R8029		1	
Metal, chrome	KA1-8030	1SFA616920R8030		1	

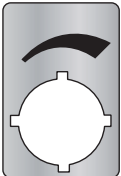

2CDC 252 043 F0209

Marker label 29.6 x 44.5 mm

Marker label

Caption	Type	Order code	Price 1 piece	Pack.- unit pieces	Weight 1 piece g / oz
Symbol (see illustration)	SK 615 562-87	GJD6155620R0087		1	0.002
Scale 0 - 10	SK 615 562-88	GJD6155620R0088		1	0.002
Scale 0 - 30	MA16-1060	1SFA611940R1060		1	0.002

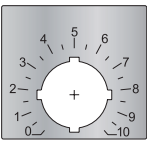

2CDC 252 044 F0209

Marker label with scale 0-10
48.5 x 44.5 mm

Accessories for CT-S in new housing (1SVR7...)

Description	Type	Order code	Price 1 piece	Pack.- unit pieces	Weight 1 piece g / oz
Adapter for screw mounting	ADP.01	1SVR430029R0100		1	0.018 (0.040)
Sealable transparent cover	COV.11	1SVR730005R0100		1	0.004 (0.009)
Marker label for devices w/o DIP switches	MAR.01	1SVR366017R0100		10	0.001 (0.002)
Marker label for devices with DIP switches	MAR.12	1SVR730006R0000		10	0.001 (0.002)

Accessories for CT-S in old housing (1SVR4...)

Description	Type	Order code	Price 1 piece	Pack.- unit pieces	Weight 1 piece g / oz
Adapter for screw mounting	ADP.01	1SVR430029R0100		1	0.018 (0.040)
Sealable transparent cover	COV.01	1SVR430005R0100		1	0.004 (0.009)
Marker label for devices w/o DIP switches	MAR.01	1SVR366017R0100		10	0.001 (0.002)
Marker label for devices with DIP switches	MAR.02	1SVR430043R0000		10	0.001 (0.002)



2CDC 255 006 80011

Sealable transparent cover for
CT-S in new housing

CT-S range

Connection diagrams

CT-MVS.21

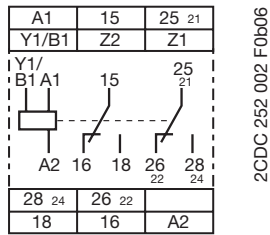

A1-A2 Supply: 24-240 V AC/DC
 A1-Y1/B1 Control input
 15-16/18 1. c/o contact
 25-26/28 2. c/o contact
 21-22/24 2. c/o contact as instantaneous contact
 Z1-Z2 Remote potentiometer connection

CT-MVS.22

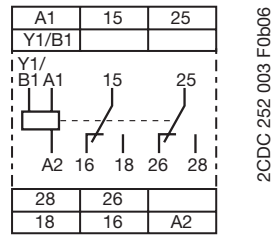

A1-A2 Supply: 224-48 V DC or 24-240 V AC
 A1-Y1/B1 Control input
 15-16/18 1. c/o contact
 25-26/28 2. c/o contact

CT-MVS.23

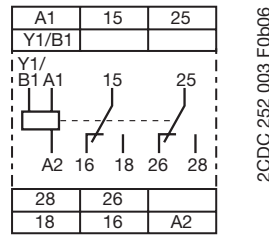

A1-A2 Supply: 380-440V AC
 A1-Y1/B1 Control input
 15-16/18 1. c/o contact
 25-26/28 2. c/o contact

CT-MVS.12

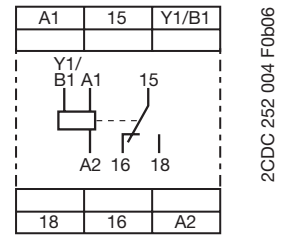

A1-A2 Supply: 24-48 V DC or 24-240 V AC
 A1-Y1/B1 Control input
 15-16/18 1. c/o contact

CT-MXS.22

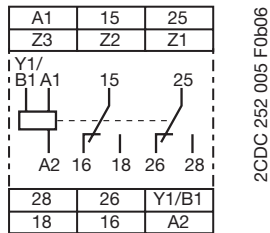

A1-A2 Supply: 24-48 V DC or 24-240 V AC
 A1-Y1/B1 Control input
 15-16/18 1. c/o contact
 25-26/28 2. c/o contact
 Z1-Z2 Remote potentiometer connection
 Z3-Z2 Remote potentiometer connection

CT-MFS.21

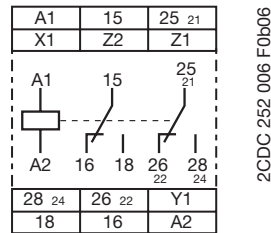

A1-A2 Supply: 24-240 V AC/DC
 15-16/18 1. c/o contact
 25-26/28 2. c/o contact
 21-22/24 2. c/o contact as instantaneous contact
 Y1-Z2 Control input
 X1-Z2 Control input
 Z1-Z2 Remote potentiometer connection

CT-MBS.22

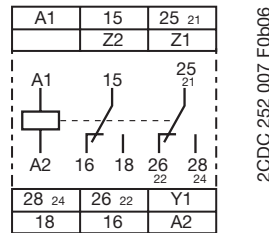

A1-A2 Supply: 24-48 V DC or 24-240 V AC
 15-16/18 1. c/o contact
 25-26/28 2. c/o contact
 21-22/24 2. c/o contact as instantaneous contact
 Y1-Z2 Control input
 Z1-Z2 Remote potentiometer connection

CT-WBS.22

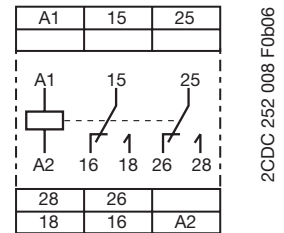

A1-A2 Supply: 24-48 V DC or 24-240 V AC
 15-16/18 1. c/o contact
 25-26/28 2. c/o contact

CT-ERS.21

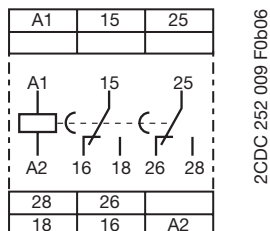

A1-A2 Supply: 24-240 V AC/DC
 15-16/18 1. c/o contact
 25-26/28 2. c/o contact

CT-ERS.22

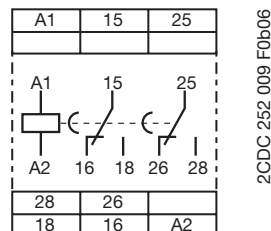

A1-A2 Supply: 24-48 V DC or 24-240 V AC
 15-16/18 1. c/o contact
 25-26/28 2. c/o contact

CT-ERS.12

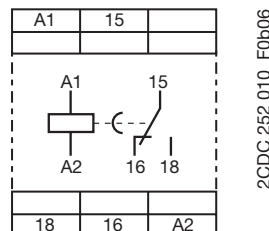

A1-A2 Supply: 24-48 V DC or 24-240 V AC
 15-16/18 1. c/o contact

CT-S range

Connection diagrams

1

CT-APS.21

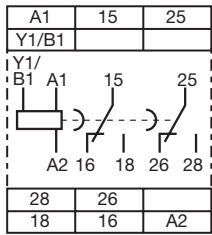

2CDC 252 011 F0b06

A1-A2 Supply: 24-240 V AC/DC
 A1-Y1/B1 Control input
 15-16/18 1. c/o contact
 25-26/28 2. c/o contact

CT-APS.22

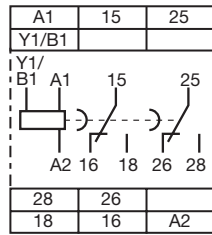

2CDC 252 011 F0b06

A1-A2 Supply: 24-48 V DC or 24-240 V AC
 A1-Y1/B1 Control input
 15-16/18 1. c/o contact
 25-26/28 2. c/o contact

CT-APS.12

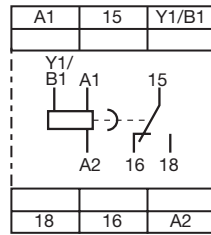

2CDC 252 012 F0b06

A1-A2 Supply: 24-48 V DC or 24-240 V AC
 A1-Y1/B1 Control input
 15-16/18 1. c/o contact

CT-AHS.22

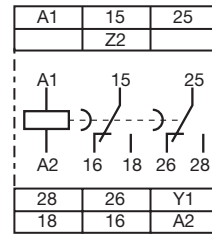

2CDC 252 013 F0b06

A1-A2 Supply: 24-48 V DC or 24-240 V AC
 Y1-Z2 Control input
 15-16/18 1. c/o contact
 25-26/28 2. c/o contact

CT-ARS.11

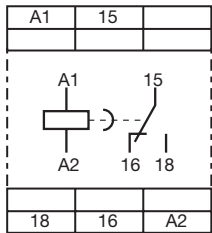

2CDC 252 014 F0b06

A1-A2 Supply: 24-240 V AC/DC
 15-16/18 1. c/o contact

CT-ARS.21

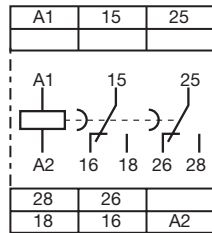

2CDC 252 015 F0b06

A1-A2 Supply: 24-240 V AC/DC
 15-16/18 1. c/o contact
 25-26/28 2. c/o contact

CT-SDS.22

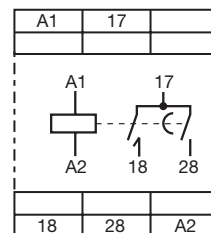

2CDC 252 016 F0b06

A1-A2 Supply: 24-48 V DC or 24-240 V AC
 17-18 1. n/o contact
 17-28 2. n/o contact

CT-SDS.23

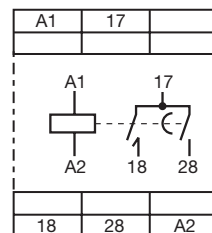

2CDC 252 016 F0b06

A1-A2 Supply: 380-440 V AC
 17-18 1. n/o contact
 17-28 2. n/o contact

CT-S range

Technical data

Data at $T_a = 25\text{ °C}$ and rated values, unless otherwise indicated

		CT-S
Input circuit - Supply circuit		
Rated control supply voltage U_s	CT-xxx.x1	24-240 V AC/DC
	CT-xxx.x2	24-48 V DC, 24-240 V AC
	CT-xxx.x3	380-440 V AC
	CT-xxx.x4	110-240 V AC
	CT-xxx.x5	220-240 V AC
	CT-xxx.x6	24 V AC/DC
	CT-xxx.x7	100-127 V AC or 110 V DC
	CT-xxx.x8	200-240V AC/DC
Rated control supply voltage U_s tolerance		-15...+10 %
Rated frequency		DC or 50/60 Hz
Frequency range AC		47-63 Hz
Typical current / power consumption		depending on device, see data sheet
Power failure buffering time	24 V DC	min. 15 ms
	230/400 V AC	min. 20 ms
Minimum energizing time		100 ms (CT-ARS)
Formatting time ¹⁾		5 min (CT-ARS)
Input circuit - Control circuit		
Kind of triggering	CT-MVS, CT-MXS, CT-APS	voltage-related triggering
Control input, Control function	A1-Y1/B1	start timing external
Parallel load / polarized		yes / no
Maximum cable length to the control input		50 m - 100 pF/m
Minimum control pulse length		20 ms
Control voltage potential		see rated control supply voltage
Current consumption of the control input	24 V DC	1.2 mA
	230 V AC	8 mA
	400 V AC	6 mA
Kind of triggering	CT-MFS, CT-MBS, CT-AHS	volt-free triggering
Control input, Control function	Y1-Z2	start timing external
	X1-Z2	pause timing / accumulative functions (CT-MFS)
Maximum switching current in the control circuit		1 mA
Maximum cable length to the control input		50 m - 100 pF/m
Minimum control pulse length		20 ms
No-load voltage at the control inputs		10-40 V DC
Remote potentiometer		
Remote potentiometer connections, Resistance value	Z1-Z2	50 k Ω (CT-MFS, CT-MBS, CT-MVS.21, CT-MXS)
	Z3-Z2	50 k Ω (CT-MXS)
Maximum cable length to remote potentiometer		2 x 25 m, shielded with 100 pF/m
Shield connection		Z2
Timing circuit		
Time ranges	10 time ranges 0.05 s - 300 h	1.) 0.05-1 s 2.) 0.15-3 s 3.) 0.5-10 s 4.) 1.5-30 s 5.) 5-100 s 6.) 15-300 s 7.) 1.5-30 min 8.) 15-300 min 9.) 1.5-30 h 10.) 15-300 h
	7 time ranges 0.05 s - 10 min (CT-SDS, CT-ARS)	1.) 0.05-1 s 2.) 0.15-3 s 3.) 0.5-10 s 4.) 1.5-30 s 5.) 5-100 s 6.) 15-300 s 7.) 0.5-10 min
Recovery time	24-240 V AC/DC	< 50 ms
	24-48 V DC, 24-240 V AC	< 80 ms
	380-440 V AC	< 60 ms
Accuracy within the rated control supply voltage tolerance		$\Delta t < 0.004\%$ / V
Accuracy within the temperature range		$\Delta t < 0.03\%$ / °C
Repeat accuracy (constant parameters)		< $\pm 0.2\%$
¹⁾ prior to first commissioning and after a six-month stop in operation		
Star-delta transition time		fixed 50 ms (CT-SDS, CT-MBS, CT-MFS, CT-MVS.2x)
Star-delta transition time tolerance		± 2 ms

CT-S range

Technical data

1

Indication of operational states		
Control supply voltage / timing	U/T: green LED	: control supply voltage applied / : timing
Control supply voltage	U: green LED	: control supply voltage applied
Relay state	R, R1, R2: yellow LED	: output relay energized
Output circuit		
Kind of output	15-16/18	relay, 1 c/o contact
	15-16/18; 25-26/28	relay, 2 c/o contacts
	15-16/18; 25(21)-26(22)/28(24)	relay, 2 c/o contacts, 2nd c/o contact selectable as inst. contact
	17-18; 17-28	relay, 2 n/o contacts (CT-SDS)
Contact material		Cd-free, on request
Rated operational voltage U _e	IEC/EN 60947-1	250 V
Minimum switching voltage / minimum switching current		12 V / 10 mA
Maximum switching voltage / maximum switching current		see load limit curves
Rated operational current I _e (IEC/EN 60947-5-1)	AC-12 (resistive) at 230 V	4 A
	AC-15 (inductive) at 230 V	3 A
	DC-12 (resistive) at 24 V	4 A
	DC-13 (inductive) at 24 V	2 A (CT-ARS; 1.5 A)
AC rating (UL 508)	Utilization category (Control Circuit Rating Code)	B 300
	max. rated operational voltage	300 V AC
	Maximum continuous thermal current at B300	5 A
	max. making/breaking apparent power at B300	3600 VA / 360 VA
Mechanical lifetime		30 x 10 ⁶ switching cycles
Electrical lifetime	at AC-12, 230 V, 4 A	0.1 x 10 ⁶ switching cycles
Max. fuse rating to achieve short-circuit protection (IEC/EN 60947-5-1)	n/c contact	6 A fast-acting
	n/o contact	10 A fast-acting
General data ²⁾		
MTBF		on request
Duty time		100%
Dimensions (W x H x D)	product dimensions	22.5 x 85.6 x 103.7 mm (0.89 x 3.37 x 4.08 in)
	packaging dimensions	97 x 109 x 30 mm (3.82 x 4.29 x 1.18 in)
Weight		depending on device, see ordering details
Mounting		DIN rail (IEC/EN 60715), snap-on mounting without any tool
Mounting position		any
Minimum distance to other units	vertical / horizontal	not necessary / not necessary
Material of housing		UL 94 V-0
Degree of protection	housing / terminals	IP50 / IP20
Electrical connection ²⁾		
Wire size	fine-strand with(out) wire end ferrule	Screw connection technology
		Easy Connect Technology (Push-in)
		1 x 0.5-2.5 mm ² (1 x 20-14 AWG) 2 x 0.5-1.5 mm ² (2 x 20-16 AWG)
	rigid	1 x 0.5-4 mm ² (1 x 20-12 AWG) 2 x 0.5-2.5 mm ² (2 x 20-14 AWG)
Stripping length		8 mm (0.32 in)
Tightening torque		0.6-0.8 Nm (5.31-7.08 lb.in)

²⁾ Data for all references 1SVR 730 xxx xxx and 1SVR 740 xxx xxx. For devices with 1SVR 430 xxx xxx please refer to the data sheet.

CT-S range

Technical data

Environmental data			
Ambient temperature ranges	operation / storage	-25...+60 °C / -40...+85 °C, -40...+60 °C / -40...+85 °C (CT-MVS.21, CT-MFS.21, CT-ERS.21, CT-APS.21)	
Damp heat (cyclic) (IEC/EN 60068-2-30)		6 x 24 h cycle, 55 °C, 95 % RH	
Vibration, sinusoidal (IEC/EN 60068-2-6)	functioning resistance	40 m/s ² , 10-58/60-150 Hz 60 m/s ² , 10-58/60-150 Hz, 20 cycles	
Vibration, seismic (IEC/EN 60068-3-3)	functioning	20 m/s ²	
Shock, half-sine (IEC/EN 60068-2-27)	functioning resistance	100 m/s ² , 11 ms, 3 shocks/direction 300 m/s ² , 11 ms, 3 shocks/direction	
Isolation data		CT-S with 1 c/o	CT-S with 2 c/o
Rated insulation voltage U _i	input circuit / output circuit	500 V	
	output circuit 1 / output circuit 2	not available	300 V
Rated impulse withstand voltage U _{imp} between all isolated circuits (IEC/EN 60664-1)		type test: 4 kV; 1.2/50 µs	
Power-frequency withstand voltage (test voltage) between all isolated circuits		routine test: 2.0 kV; 50 Hz; 1 s type test: 2.0 kV; 50 Hz; 60 s	
Basic insulation (IEC/EN 61140)	input circuit / output circuit	500 V	
Protective separation (IEC/EN 61140; EN 50178)	input circuit / output circuit	250 V	
Pollution degree	IEC/EN 60664-1	3	
Overvoltage category	IEC/EN 60664-1	III	
Standards			
Product standard		IEC 61812-1, EN 61812-1 + A11, DIN VDE 0435 part 2021	
Low Voltage Directive		2006/95/EC	
EMC Directive		2004/108/EC	
RoHS Directive		2011/65/EC	
Electromagnetic compatibility			
Interference immunity to		IEC/EN 61000-6-1, IEC/EN 61000-6-2	
electrostatic discharge	IEC/EN 61000-4-2	Level 3, 6 kV / 8 kV	
radiated, radio-frequency electromagnetic field	IEC/EN 61000-4-3	Level 3, 10 V/m (1 GHz) 3 V/m (2 GHz) 1 V/m (2.7 GHz)	
electrical fast transient / burst	IEC/EN 61000-4-4	Level 3, 2 kV / 5 kHz	
surge	IEC/EN 61000-4-5	Level 4, 2 kV A1-A2	
conducted disturbances, induced by radio-frequency fields	IEC/EN 61000-4-6	Level 3, 10 V	
harmonics and interharmonics	IEC/EN 61000-4-13	Class 3	
Interference emission		IEC/EN 61000-6-3, IEC/EN 61000-6-4	
high-frequency radiated	IEC/CISPR 22, EN 55022	Class B	
high-frequency conducted	IEC/CISPR 22, EN 55022	Class B	

Product certifications and declarations see "Approvals and marks" on page 14.

CT-S range

Technical diagrams

1

Technical diagrams

Load limit curves

AC load (resistive)

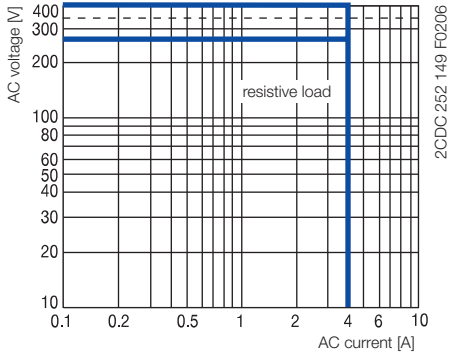

DC load (resistive)

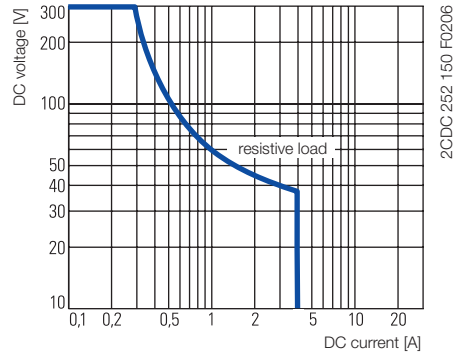

Derating factor F for inductive AC load

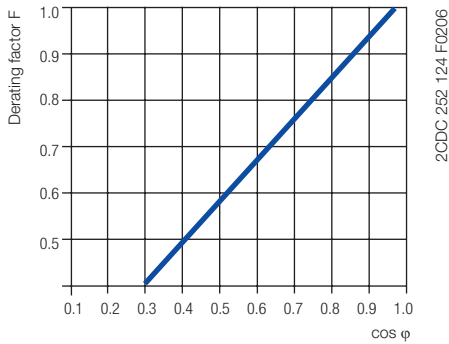

Contact lifetime

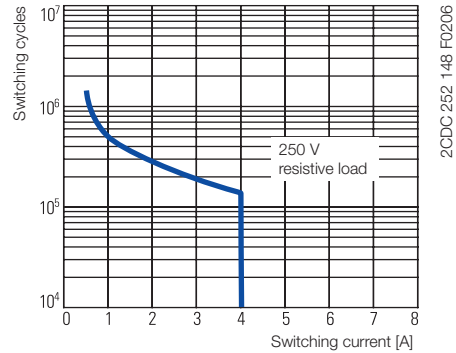

CT-S range

Wiring notes, Dimensional drawings

Wiring notes

Control inputs (volt-free triggering)

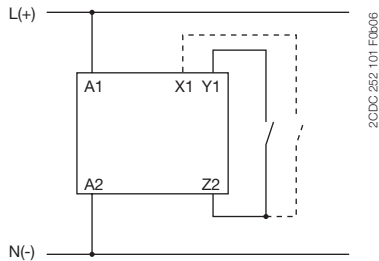

Triggering of the control inputs (volt-free) with a proximity switch (3 wire)

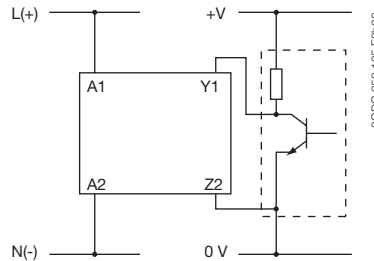

Control inputs (voltage-related triggering)

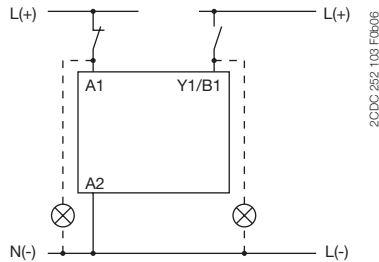
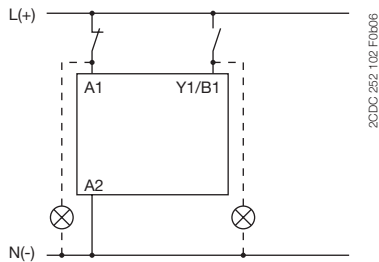

The control input Y1/B1 is triggered with electric potential against A2. It is possible to use the control supply voltage from terminal A1 or any other voltage within the rated control supply voltage range.

Remote potentiometer

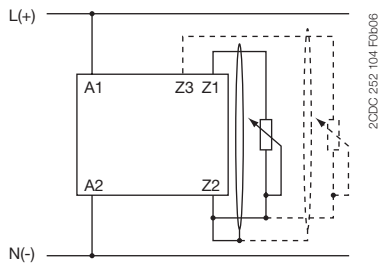

Dimensional drawing Dimensions in mm

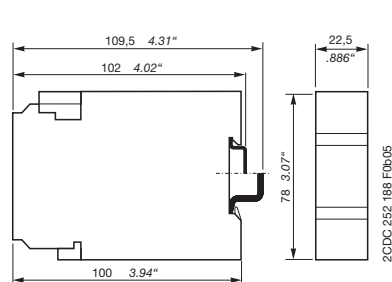

1SVR 430 xxx xxx

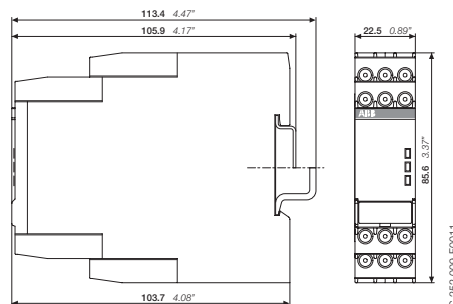

1SVR 730 xxx xxx, 1SVR 740 xxx xxx

Electronic timers

Timing functions

1

For a detailed overview of product specific timing functions please refer to the corresponding data sheet.

On delay functions

ON-delay



This function requires continuous control supply voltage for timing. Timing begins when control supply voltage is applied. When the selected time delay is complete, the output relay energizes. If control supply voltage is interrupted, the output relay de-energizes and the time delay is reset.

ON-delay accumulative



This function requires continuous control supply voltage for timing. Timing begins when control supply voltage is applied. When the selected time delay is complete, the output relay energizes. Timing can be paused by closing control input. The elapsed time t_1 is stored and continues from this time value when the control input is re-opened. If control supply voltage is interrupted, the output relay de-energizes and the time delay is reset.

OFF delay functions

OFF-delay with auxiliary voltage

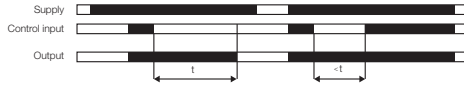

This function requires continuous control supply voltage for timing. If control input is closed, the output relay energizes immediately. If control input is opened, the time delay starts. When the selected time delay is complete, the output relay de-energizes. If control input recloses before the time delay is complete, the time delay is reset and the output relay does not change state. Timing starts again when control input A1-Y1/B1 re-opens. If control supply voltage is interrupted, the output relay de-energizes and the time delay is reset.

OFF-delay without auxiliary voltage



The OFF-delay function without auxiliary voltage does not require continuous control supply voltage for timing. Applying control supply voltage, energizes the output relay. If control supply voltage is interrupted, the OFF-delay starts. When timing is complete, the output relay de-energizes. If control supply voltage is re-applied before the time delay is complete, the time delay is reset and the output relay remains energized. Control supply voltage must be applied for the minimum energizing time (200 ms), for proper operation.

OFF-delay with auxiliary voltage (Delay on break)

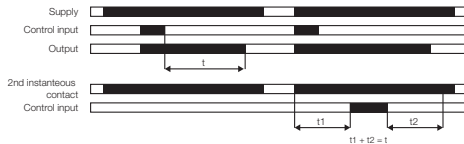

This function requires continuous control supply voltage for timing. If control input is closed, the output relay energizes immediately. If control input is opened, the time delay starts. When the selected time delay is complete, the output relay de-energizes. If control input closes before the time delay is complete, the time delay is reset and the output relay does not change state. Timing starts again when control input reopens. Pause timing / Accumulative OFF-delay: Timing can be paused by closing control input X1-Z2. The elapsed time t_1 is stored and continues from this time value when X1-Z2 is re-opened. This can be repeated as often as required. If control supply voltage is interrupted, the output relay de-energizes and the time delay is reset.

Impulse-ON functions

Impulse-ON (interval)



This function requires continuous control supply voltage for timing. The output relay energizes immediately when control supply voltage is applied and de-energizes after the set pulse time is complete. If control supply voltage is interrupted, the output relay de-energizes and the time delay is reset.

Electronic timers

Timing functions

Impulse-OFF functions

Impulse-OFF

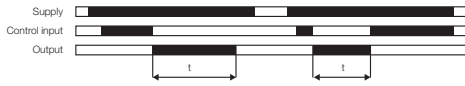

This function requires continuous control supply voltage for timing. The output relay energizes immediately when the control input is de-energized and the output de-energizes after the set pulse time is complete. If control supply voltage is interrupted, the output relay de-energizes and the time delay is reset.

Impulse-OFF without auxiliary voltage

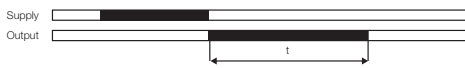

This function does not require continuous control supply voltage for timing. If control supply voltage is interrupted, the output relay energizes and the OFF time starts. When timing is complete, the output relay de-energizes. If control supply voltage is re-applied before the time delay is complete, the time delay is reset and the output relay de-energizes. Control supply voltage must be applied for the minimum energizing time (200 ms), for proper operation.

Impulse-OFF with auxiliary voltage (Trailing edge interval)

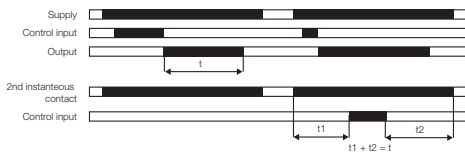

This function requires continuous control supply voltage for timing. If control supply voltage is applied, opening control input energizes the output relay immediately and starts timing. When the selected pulse time is complete, the output relay de-energizes. Closing control input, before the time delay is complete, de-energizes the output relay and resets the time delay. If control supply voltage is interrupted, the output relay de-energizes and the time delay is reset.

Impuls-ON and Impulse-OFF functions

Impulse-ON and impulse-OFF

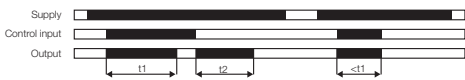

This function requires continuous control supply voltage for timing. If control supply voltage is applied, closing control input energizes the output relay immediately and starts the pulse time t_1 . When t_1 is complete, the output relay de-energize. Re-opening control input energizes the output relay immediately and starts the pulse time t_2 . When t_2 is complete, the output relay de-energizes. t_1 and t_2 are independently adjustable. If control input changes state before the pulse time is complete, the output relay de-energizes and the pulse time is reset. If control input changes state again, the interrupted pulse time restarts. If control supply voltage is interrupted, the output relay de-energizes and the time delay is reset.

Flasher starting with ON functions

Flasher starting with ON



Applying control supply voltage starts timing with symmetrical ON & OFF times. The cycle starts with an ON time first. If control supply voltage is interrupted, the output relay de-energizes and the time delay is reset.

Flasher with reset starting with ON

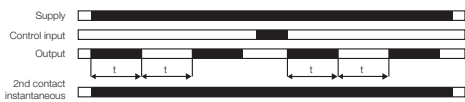

Applying control supply voltage starts timing with symmetrical ON & OFF times. The cycle starts with an ON time first. The time delay can be reset by closing control input. Opening control input starts the timer pulsing again with symmetrical ON & OFF times. If control supply voltage is interrupted, the output relay de-energizes and the time delay is reset.

Flasher starting with OFF functions

Flasher starting with OFF



Applying control supply voltage starts timing with symmetrical ON & OFF times. The cycle starts with an OFF time first. If control supply voltage is interrupted, the output relay de-energizes and the time delay is reset.

Flasher with reset starting with OFF

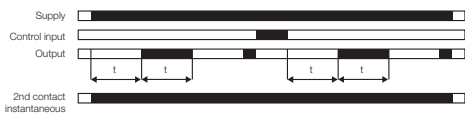

Applying control supply voltage starts timing with symmetrical ON & OFF times. The cycle starts with an OFF time first. The time delay can be reset by closing control input. Opening control input starts the timer pulsing again with symmetrical ON & OFF times. If control supply voltage is interrupted, the output relay de-energizes and the time delay is reset.

Flasher starting with ON or OFF functions

Flasher starting with ON or OFF



Applying control supply voltage starts timing with symmetrical ON / OFF times. If the control input is open during supply voltage is connected the cycle starts with an ON time first. If the control input is closed during supply voltage is connected the cycle starts with an OFF time first.

Electronic timers

Timing functions

1

Pulse former

Pulse former (single shot)



This function requires continuous control supply voltage for timing. Closing control input energizes the output relay immediately and starts timing. Operating the control input during the time delay has no effect. When the selected ON time is complete, the output relay de-energizes. After the ON time is complete, it can be restarted by closing control input. If control supply voltage is interrupted, the output relay de-energizes and the time delay is reset.

Single-pulse former

Single-pulse generator, starting with OFF

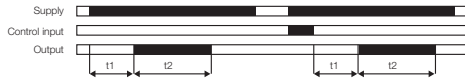

This function requires continuous control supply voltage for timing. Applying control supply voltage, or, if control supply voltage is already applied, opening control input energizes the output relay after the OFF time t_1 is complete. When the following ON time t_2 is complete, the output relay de-energizes. The ON & OFF times are independently adjustable. Closing control input with control supply voltage applied, de-energizes the output relay and resets the time delay. If control supply voltage is interrupted, the output relay de-energizes and the time delay is reset.

Impulse with delay

Fixed impulse with adjustable time delay



This function requires continuous control supply voltage for timing. The time delay t_1 starts when control supply voltage is applied. When t_1 is complete, the output relay energizes for the fixed impulse time t_2 of 500 ms. If control supply voltage is interrupted, the time delay is reset. The output relay does not change state.

Adjustable impulse with fixed time delay



This function requires continuous control supply voltage for timing. Applying control supply voltage starts the fixed time delay t_2 of 500 ms. When t_2 is complete, the output relay energizes and the selected pulse time t_1 starts. When t_1 is complete, the output relay de-energizes. If control supply voltage is interrupted, the pulse time is reset. The output relay does not change state.

ON- and OFF-delay

ON- and OFF-delay



This function requires continuous control supply voltage for timing. Closing the control input the ON delay starts. After the ON delay time is elapsed the output energizes. Opening the control input let the OFF delays time start. When the OFF delay time is elapsed the output de-energizes again. Operating the control input during timing will reset the respective timing function.

Symmetrical ON- and OFF-delay

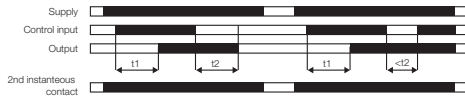

This function requires continuous control supply voltage for timing. Closing control input starts the ON-delay time t_1 . When timing is complete, the output relay energizes. Opening control input starts the OFF-delay time t_2 . When the OFF-delay t_2 is complete, the output relay de-energizes. If control input opens before the ON-delay t_1 is complete, the time delay is reset and the output relay remains de-energized. If control input closes before the OFF-delay time t_2 is complete, the time delay is reset and the output relay remains energized.

Asymmetrical ON- and OFF-delay

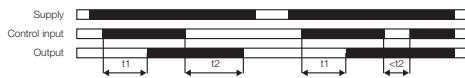

This function requires continuous control supply voltage for timing. Closing control input starts the ON-delay t_1 . When timing is complete, the output relay energizes. Opening control input starts the OFF-delay t_2 . When the OFF-delay is complete, the output relay de-energizes. The ON-delay and OFF-delay are independently adjustable. If control input opens before the ON-delay is complete ($<t_1$), the time delay is reset and the output relay remains de-energized. If control input closes before the OFF-delay is complete ($<t_2$), the time delay is reset and the output relay remains energized. If control supply voltage is interrupted, the output relay de-energizes and the time delay is reset.

Electronic timers

Timing functions

Further functions



This function is used for test purposes during commissioning and troubleshooting.
 If the selected max. value of the time range is smaller than 300 h (front-face potentiometer "Time sector" \neq 300 h), applying control supply voltage energizes the output relay immediately. Interrupting control supply voltage, de-energizes the output relay.
 If the selected max. value of the time range is 300 h (front-face potentiometer "Time sector" = 300 h) and control supply voltage is applied the output relay does not energize.

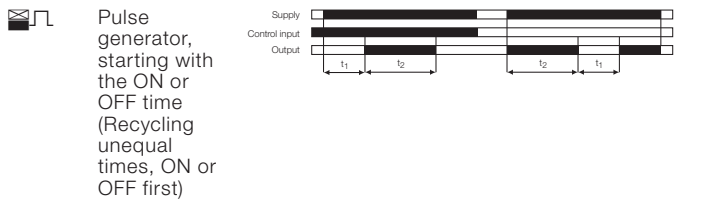

This function requires continuous control supply voltage for timing. Applying control supply voltage, with open control input, starts timing with an ON time first. Applying control supply voltage, with closed control input, starts timing with an OFF time first. If control supply voltage is interrupted, the output relay de-energizes and the time delay is reset.

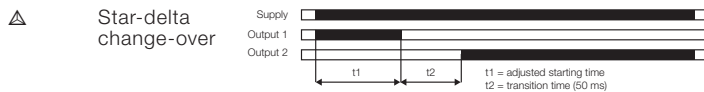

Applying control supply voltage energizes the star contactor and begins the set starting time. When the starting time is complete the star contactor de-energizes. Now, the fix transition time starts. When the transition time is complete, the delta contactor energizes.

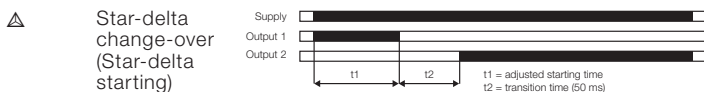

This function requires continuous control supply voltage for timing. Applying control supply voltage, energizes the star contactor and begins the set starting time t_1 . When the starting time is complete, the first output contact de-energizes the star contactor. When the transition time t_2 is complete, the second output contact energizes the delta contactor. The delta contactor remains energized as long as control supply voltage is applied.

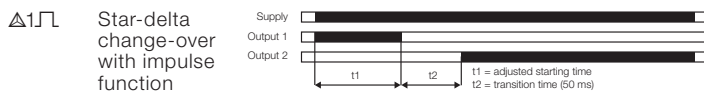

This function requires continuous control supply voltage for timing. Applying control supply voltage energizes the star contactor connected to output 1 and begins the set starting time t_1 . When the starting time is complete, the first output de-energizes the star contactor.
 Now, the fixed transition time t_2 of 50 ms starts. When the transition time is complete, the second output energizes the delta contactor. The delta contactor remains energized as long as control supply voltage is applied.

Measuring and monitoring relays

Product group picture

2



Measuring and monitoring relays

Table of contents

Measuring and monitoring relays

Measuring and monitoring relays	52
Current and voltage monitoring relays, single-phase	60
Three-phase monitoring relays	78
Grid feeding monitoring relays -	
Voltage and frequency monitoring functions	100
Insulation monitoring relays for unearthed supply systems	110
Motor load monitoring relays	124
Thermistor motor protection relays	136
Temperature monitoring relays.....	150
Liquid level monitors and controls.....	162
General technical data, Accessories, Current transformers	173

Measuring and monitoring relays

Benefits and advantages

CM-N range: Multifunctional



- 45 mm wide housing
- Output contacts: 2 c/o (SPDT) contacts
- Continuous voltage range (24-240 V AC/DC) or single-supply
- Setting and operation via front-face operating controls
- Adjustment of threshold values and switching hysteresis via direct reading scale
- Adjustable time delays
- Integrated and snap-fitted front-face marker label
- Sealable transparent cover (accessory)

CM-S range: Universal and multifunctional



- Only 22.5 mm wide housing
- Output contacts: 1 or 2 c/o (SPDT) contacts
- One supply voltage range or supplied by measuring circuit
- Setting and operation via front-face operating controls
- Adjustment of threshold values and switching hysteresis via direct reading scale
- Integrated and snap-fitted front-face marker
- Snap-on housing: The relays can be placed on a DIN rail tool-free - just snap it on or remove it tool-free
- Sealable transparent cover (accessory)

CM-E range: Economy



- Only 22.5 mm wide housing
- Output contacts: 1 c/o contact or 1 n/o contact
- One supply voltage range
- One monitoring function
- Cost-efficient solution for OEM applications
- Preset monitoring ranges

ABB's measuring and monitoring relays in a new housing

Benefits at a glance

Easy Connect Technology

New options:

Additionally to the existing well established screw connections a new innovative connection technology can be offered: Easy Connect Technology with push-in terminals.

Tool-free wiring:

The push-in terminals can be wired with rigid or fine stranded wires with wire end ferrules totally tool-free. The connection direction is exactly the same as the screw version.

Higher utility class:

The Easy Connect Technology provides excellent vibration resistance with gas tight push-in terminals – the right solution for harsh environment.

Extended features

Flammability:

The plastic housing material used meets the requirements for the highest flammability class. (UL94 V-0 rated)

Look and feel:

The new housing fits perfectly with ABB's control products offer.

Measuring and monitoring relays

Benefits and advantages

Higher utility class ①

The Easy Connect Technology provides excellent vibration resistance with gas tight push-in terminals – the right solution for harsh environment. Selected products of the electronic timers and measuring and monitoring relays comply to the latest rail standards NF F 16-101/102, EN 45545, EN 50155 and more standards which are relevant for railway applications. Find more information in the rail brochure 2CDC110084B0201.

Safety ②

The “real distance” is hidden. The clearance and the creepage distances of our products exceed international standards and substantially increase the safety of our products.

Easy Connect Technology ③

Tool-free wiring and excellent vibration resistance. Push-in terminals provide connection of wires up to 2 x 0.5 - 1.5 mm² (2 x 20 -16 AWG), rigid or fine-strand with or without wire end ferrules. The extended type designators for products with push-in terminals are indicated by a **P** following the extended type designator e.g. CM-xxS.xx**P**.

Double-chamber cage connection terminals ④

Double-chamber cage connection terminals provide connection of wires up to 2 x 0.5-2.5 mm² (2 x 20-14 AWG) rigid or fine-strand, with or without wire end ferrules. Potential distribution does not require additional terminals. The extended type designators for products with double-chamber cage connection terminals are indicated by a **S** following the extended type designator e.g. CM-xxS.xx**S**.

LED's for status indication ⑤

All actual operational states are displayed by front-face LEDs, thus simplifying commissioning and troubleshooting.

Integrated marker label ⑥

Integrated marker labels allow the product to be marked quickly and simply. No additional marker labels are required.

Sealable transparent cover ⑦

Protection against unauthorized changes of time and threshold values. Available as an accessory.

Snap-On housing ⑧

Tool-free DIN rail installation and deinstallation of the monitoring relay.

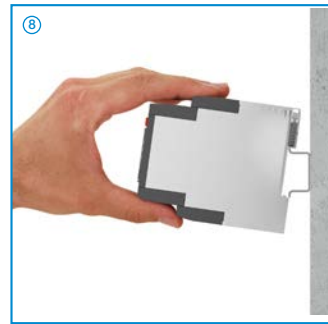
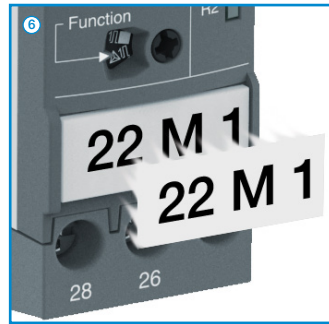
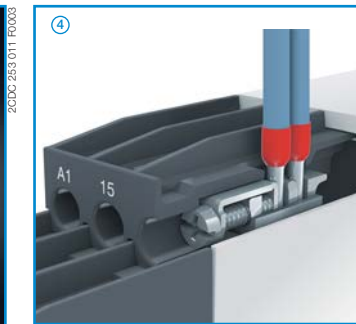
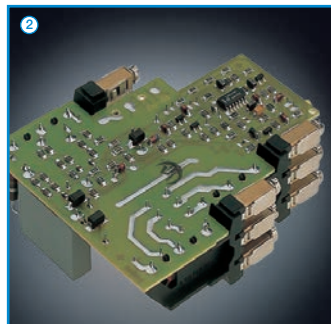
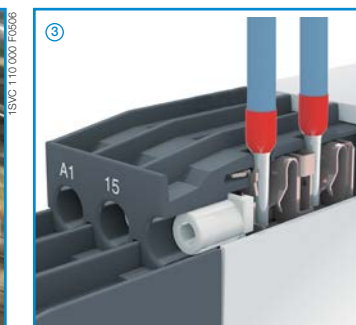
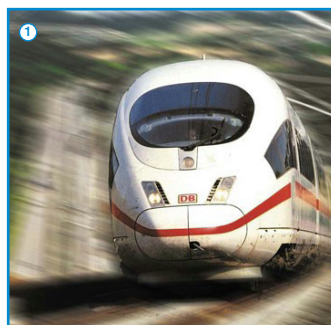

Measuring and monitoring relays

Assortment overview

2

Single-phase current and voltage monitoring

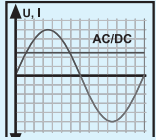

Current monitoring

- Monitoring of motor current consumption
- Monitoring of lighting installations and heating circuits
- Monitoring of transportation equipment overload
- Monitoring of locking devices, electromechanical brake gear and locked rotors

See „Ordering details - Current monitoring relays“ on page 64.

Voltage monitoring

- Speed monitoring of DC motors
- Monitoring of battery voltages and other supply networks

See “Ordering details - Voltage monitoring relays” on page 66.

Grid feeding monitoring relays

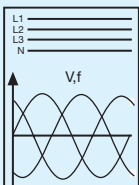

The CM-UFx range monitors all voltage and frequency parameters in a grid and ensures the safe feeding of decentral produced electrical energy into the grid.

- Monitoring of the voltage with up to 2 thresholds for over- and undervoltage
- Monitoring of the frequency with up to 2 thresholds for over- and underfrequency
- ROCOF (rate of change of frequency) and vector shift detection
- In compliance with several local standards

See „Ordering and selection“ on page 104.

Three-phase monitoring

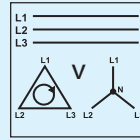

- Voltage monitoring of mobile three-phase equipment
- Protection of personnel and installations against phase reversal
- Monitoring of the supply voltage of machines and installations
- Protection of equipment against damage caused by unstable supply voltage
- Switching to emergency or auxiliary supply
- Protection of motors against damage caused by unbalanced phase voltages and phase loss

See “Ordering details - Singlefunctional” on page 82 or “Ordering details - Multifunctional” on page 84.

Motor load monitoring

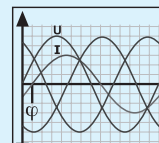

CM-LWN monitoring relays load states of single- and three-phase asynchronous motors.

- Detection of V-belt breaking
- Motor protection against overload
- Monitoring of filters for clogging
- Protection of pumps against dry running
- Detection of high pressure in conduit systems
- Monitoring for dulling blades in sawing and cutting machines

See “Ordering details” on page 126.

Measuring and monitoring relays

Assortment overview

Insulation monitoring

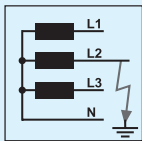

- Monitoring of electrically isolated supply mains for insulation resistance failure
- Detection of initial faults
- Protection against earth faults

See "Ordering details" on page 116.

Temperature monitoring

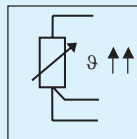

- Acquisition, messaging and regulation of temperatures of solid, liquid and gaseous media in processes and machines
- Motor and system protection
 - Control panel temperature monitoring
 - Frost monitoring
 - Temperature limits for process variables, e.g. in the packing or electroplating industry
 - Control of systems and machines like heating, air-conditioning and ventilation systems, solar collectors, heat pumps or hot water supply systems
 - Monitoring of servomotors with KTY sensors
 - Bearing and gear oil monitoring
 - Coolant monitoring

See "Ordering details" on page 154.

Thermistor motor protection

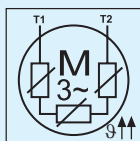

- CM-MSE and CM-MSS provide full protection of motors with integrated PTC resistor sensors.
- Protection of motors against thermal overload, e. g. caused by insufficient cooling, heavy load starting conditions, undersized motors, etc.

See "Ordering details" on page 140.

Liquid level monitoring and control

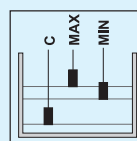

- Protection of pumps against dry running
- Protection against container overflow
- Control of liquid levels
- Detection of leaks
- Control of mixing ratios

See "Ordering details" on page 166.

Measuring and monitoring relays

Approvals and marks

2











■ existing □ pending		Current and voltage monitoring, single-phase								Three-phase monitoring													
		CM-SRS.1xS/P	CM-SRS.2xS	CM-SRS.MS/P	CM-SFS.2S/P	CM-ESS.1xS/P	CM-ESS.2xS	CM-ESS.MS/P	CM-EFS.2S/P	CM-PBE	CM-PVE	CM-PFE	CM-PFS.S/P	CM-PSS.x1S/P	CM-PVS.x1S/P	CM-PVS.81S/P	CM-PAS.x1S/P	CM-MPS.x1S/P	CM-MPS.x3S/P	CM-MPN.52S/P	CM-MPN.62S/P	CM-MPN.72S/P	
Approvals																							
	UL 508, CAN/CSA C22.2 No.14	■	■	■	■	■	■	■	■	■	■	■	■	■	■	■	■	■	■	■	■	■	■
	GL	■	■	■	■	■	■	■	■	■	■	■	■	■	■	■	■	■	■	■	■	■	■
	EAC	■	■	■	■	■	■	■	■	■	■	■	■	■	■	■	■	■	■	■	■	■	■
	CB scheme	■	■	■	■	■	■	■	■	■	■	■	■	■	■	■	■	■	■	■	■	■	■
	CCC	■	■	■	■	■	■	■	■	■	■	■	■	■	■	■	■	■	■	■	■	■	■
	RMRS	■	■	■	■	■	■	■	■	■	■	■	■	■	■	■	■	■	■	■	■	■	■
	Rail applications ¹⁾	■	■	■		■	■																
Marks																							
	CE	■	■	■	■	■	■	■	■	■	■	■	■	■	■	■	■	■	■	■	■	■	■
	RCM	■	■	■	■	■	■	■	■	■	■	■	■	■	■	■	■	■	■	■	■	■	■

■ existing □ pending		Insulation monitoring relays for ungrounded supply mains					Motor load monitoring			Tempera- ture monitoring			Grid feeding monitoring relays			
		CM-IWS.2S/P	CM-IWS.1S/P	CM-IWN.1S/P	CM-IWN.4,5,6.S/P	CM-IWN.S/P	CM-LWN			CM-TCS.xxS/P	C512	C513	CM-UFD.M22	CM-UFD.M31	CM-UFD.M33	CM-UFD.M34
Approvals																
	UL 508, CAN/CSA C22.2 No.14	■	■	■	■	■	■	■	■	■	■	■	■	■	■	■
	GL	■	■	■		■	■	■	■	■	■	■	■	■	■	■
	EAC	■	■	■	■	■	■	■	■	■	■	■	■	■	■	■
	CB scheme	■	■	■	■	■	■	■	■	■	■	■	■	■	■	■
	CCC	■	■	■	■	■	■	■	■	■	■	■	■	■	■	■
	RMRS	■	■	■	■	■	■	■	■	■	■	■	■	■	■	■
	Rail applications ¹⁾	■		■		■										
	CEI 0-21															
	G59/3 LV + G83/2, G59/3 HV															
	VDE-AR-N 4105 „Erzeugungsanlagen am Niederspannungsnetz“															
	BDEW „Erzeugungsanlagen am Mittelspannungsnetz“															
	DRRG standard of DEWA															
Marks																
	CE	■	■	■	■	■	■	■	■	■	■	■	■	■	■	■
	RCM	■	■	■	■	■	■	■	■	■	■	■	■	■	■	■

¹⁾ Applicable in rail application following the latest standards for rail applications: NF F 16-101/102 (I2/F2 classified), EN 45545 (Hazard Level 3), DIN 5510, EN 50155, IEC 60571. Further information is available in our rail segment brochure 2CDC110084B0201.

Measuring and monitoring relays

Approvals and marks

■ existing □ pending		Thermistor motor protection							Liquid level monitoring			
		CM-MSE	CM-MSS.x1S/P	CM-MSS.12S/P	CM-MSS.13S/P	CM-MSS.22S/P	CM-MSS.23S/P	CM-MSS.32S/P	CM-MSS.33S/P	CM-ENE MIN	CM-ENE MAX	CM-ENS.xxS/P
Approvals												
	UL 508, CAN/CSA C22.2 No.14	■	■	■	■	■	■	■	■	■	■	■
	GL		■	■	■	■	■	■	■			□
	EAC	■	■		■	■	■	■	■	■	■	■
	II (2) G D, PTB 02 ATEX 3080		■						■	■		
	CB scheme	■	■	■		■	■	■	■	■	■	
	CCC	■	■	■	■	■	■	■	■	■	■	■
	RMRS	■								■	■	□
	ATEX		■					■	■			
	DNV											□
Marks												
	CE	■	■	■	■	■	■	■	■	■	■	■
	RCM	■	■	■	■	■	■	■	■	■	■	■

Current and voltage monitoring relays, single-phase Product group picture

2

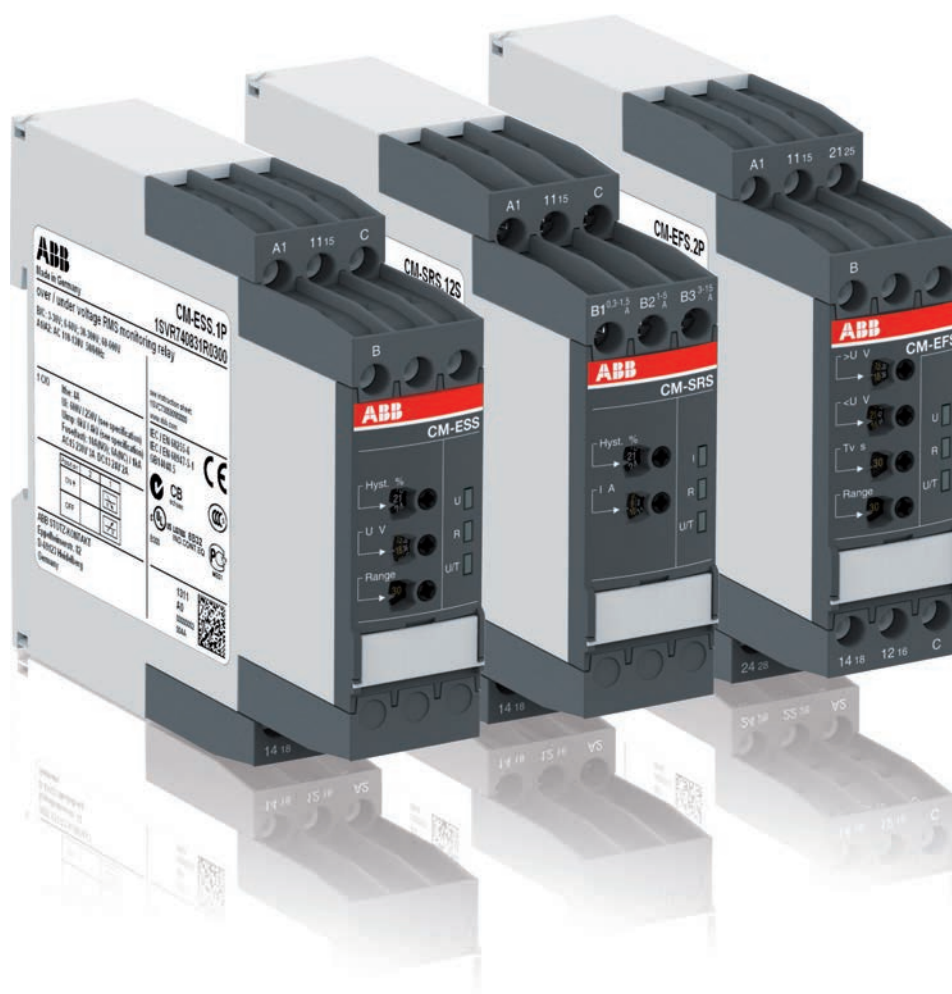

Current and voltage monitoring relays, single-phase

Table of contents

Current and voltage monitoring relays, single-phase

Current and voltage monitoring relays, single-phase	60
Benefits and advantages	61
Operating controls	62
Selection table - Current monitoring relays	63
Ordering details - Current monitoring relays	64
Selection table - Voltage monitoring relays	65
Ordering details - Voltage monitoring relays	66
Function diagrams	67
Connection diagrams, DIP switches	70
Technical data - Current monitoring relays	72
Technical data - Voltage monitoring relays	74

Current and voltage monitoring relays, single-phase

Benefits and advantages

2

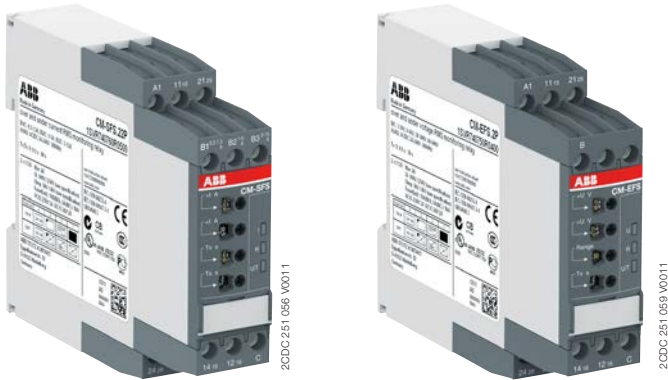

Characteristics current and voltage monitoring relays

- Monitoring of DC and AC currents: 3 mA to 15 A ¹⁾
- Monitoring of DC and AC voltages from 3-600 V
- TRMS measuring principle
- One device includes 3 measuring ranges
- One device includes 4 measuring ranges: 3-30 V; 6-60 V; 30-300 V; 60-600 V
- Over- and undercurrent monitoring¹⁾
- Over- and undervoltage monitoring¹⁾
- ON or OFF-delay configurable¹⁾
- Open- or closed-circuit principle configurable¹⁾
- Threshold values for >U and/or <U adjustable¹⁾
- Latching function configurable¹⁾
- Thresholds for >I and/or <I adjustable¹⁾
- Fixed hysteresis of 5 %¹⁾
- Start-up delay T_v adjustable 0; 0.1-30 s¹⁾
- Tripping delay T_v adjustable 0; 0.1-30 s¹⁾
- 1 x 2 c/o contacts (common signal) or 2 x 1 c/o contact (separate signals for >I and <I) configurable ¹⁾
- 1 x 2 c/o contacts (common signal) or 2 x 1 c/o contact (separate signals for >U and <U) configurable¹⁾
- 22.5 mm width
- 3 LEDs for the indication of operational states
- Approvals / Marks

/ CE ²⁾

¹⁾ depending on device

²⁾ Applicable in rail application following the latest standards for rail applications: NF F 16-101/102 (I2/F2 classified), EN 45545 (Hazard Level 3), DIN 5510, EN 50155, IEC 60571. Further information is available in our rail segment brochure 2CDC110084B0201.

Current monitoring, single-phase

The ABB current monitoring relays CM-SRS.xx reliably monitor the occurrence of currents that exceed or fall below the selected threshold value. The functions overcurrent or undercurrent monitoring can be preselected. Single- and multifunction devices for the monitoring of direct or alternating currents from 3 mA to 15 A are available.

Current window monitoring (I_{min} , I_{max})

The window monitoring relay CM-SFS.2x is available if the application requires the simultaneous monitoring of over- and undercurrents.

Voltage monitoring, single-phase

The ABB voltage monitoring relays CM-SRS.xx are used to monitor direct and alternating voltages within a range of 3-600 V. Over- or undervoltage detection can be preselected.

Voltage window monitoring (U_{min} , U_{max})

For the simultaneous detection of over- and undervoltages, the window monitoring relay CM-EFS.2 can be used.

Current and voltage monitoring relays, single-phase

Operating controls

Current monitoring relays

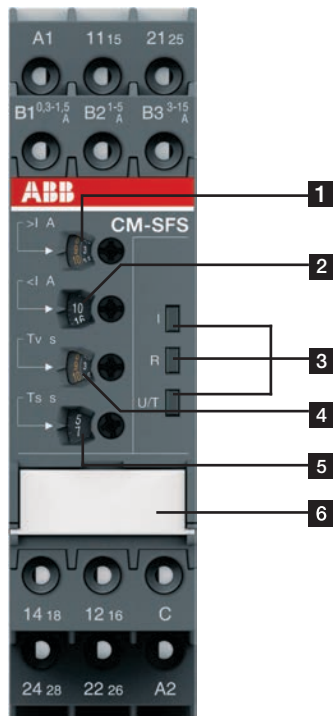

2CDC 253 018 F0013

- 1** Adjustment of the threshold value $>I$ for overcurrent
- 2** Adjustment of the threshold value $<I$ for undercurrent
- 3** Indication of operational states
 - U/T: green LED – control supply voltage/timing
 - R: yellow LED – relay status
 - I: red LED – over- / undercurrent

- 4** Adjustment of the tripping delay T_v
- 5** Adjustment of the start-up delay T_s
- 6** DIP switches (see DIP switch functions on page 2/20)
 - ON-delay
 - OFF-delay
 - Closed-circuit principle
 - Open-circuit principle
 - Latching function activated
 - Latching function not activated
 - 2x1 c/o (SPDT) contact
 - 1x2 c/o (SPDT) contacts

Voltage monitoring relays

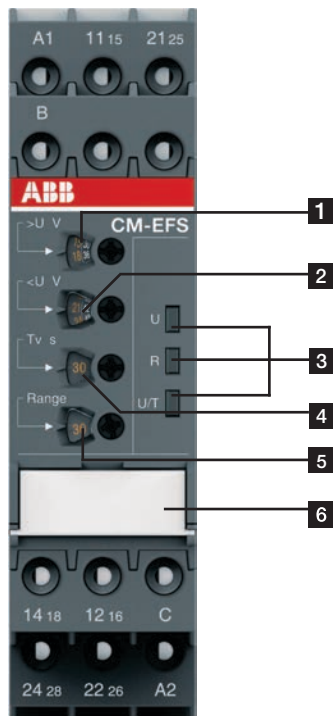

2CDC 253 014 F0013

- 1** Adjustment of the threshold value $>U$ for overvoltage
- 2** Adjustment of the threshold value $<U$ for undervoltage
- 3** Indication of operational states
 - U/T: green LED – control supply voltage/timing
 - R: yellow LED – relay status
 - U: red LED – over- / undervoltage

- 4** Adjustment of the tripping delay T_v
- 5** Adjustment of the measuring range
- 6** DIP switches (see DIP switch functions on page 2/20)
 - ON-delay
 - OFF-delay
 - Closed-circuit principle
 - Open-circuit principle
 - Latching function activated
 - Latching function not activated
 - 2x1 c/o (SPDT) contact
 - 1x2 c/o (SPDT) contacts

Current and voltage monitoring relays, single-phase

Selection table - Current monitoring relays

2

Type	Order number	1	2	3	4	5	6	7	8	9	10	11	12	13	14	15	16	17	18	19	20	21	22		
CM-SFS.11S	1SVR730840R0200																								
CM-SFS.11P	1SVR740840R0200																								
CM-SFS.11S	1SVR730841R0200																								
CM-SFS.11P	1SVR740841R0200																								
CM-SFS.11S	1SVR730841R1200																								
CM-SFS.11P	1SVR740841R1200																								
CM-SFS.12S	1SVR730840R0300																								
CM-SFS.12S	1SVR730841R0300																								
CM-SFS.21S	1SVR730841R1300																								
CM-SFS.21S	1SVR730840R0400																								
CM-SFS.21P	1SVR740840R0400																								
CM-SFS.21S	1SVR730841R0400																								
CM-SFS.21P	1SVR740841R0400																								
CM-SFS.21S	1SVR730841R1400																								
CM-SFS.21P	1SVR740841R1400																								
CM-SFS.22S	1SVR730840R0500																								
CM-SFS.22S	1SVR730841R0500																								
CM-SFS.M1S	1SVR730840R0600																								
CM-SFS.M1P	1SVR740840R0600																								
CM-SFS.M2S	1SVR730840R0700																								
CM-SFS.21S	1SVR730760R0400																								
CM-SFS.21P	1SVR740760R0400																								
CM-SFS.22S	1SVR730760R0500																								

Rated control supply voltage U_s	1	2	3	4	5	6	7	8	9	10	11	12	13	14	15	16	17	18	19	20	21	22		
24 - 240 V AC/DC	■	■																						
110 - 130 V AC			■	■																				
220 - 240 V AC					■	■																		

Measuring ranges AC/DC	1	2	3	4	5	6	7	8	9	10	11	12	13	14	15	16	17	18	19	20	21	22	
3 - 30 mA	■	■	■	■	■	■																	
10 - 100 mA	■	■	■	■	■	■																	
0.1 - 1 A	■	■	■	■	■	■																	
0.3 - 1.5 A							■	■	■														
1 - 5 A							■	■	■														
3 - 15 A							■	■	■														

Monitoring function	1	2	3	4	5	6	7	8	9	10	11	12	13	14	15	16	17	18	19	20	21	22		
Over- or undercurrent	■	■	■	■	■	■	■	■	■	■	■	■	■	■	■	■	■	■	■	■	■	■	■	
Window current monitoring																						■	■	■
Latching																						sel	sel	sel
Open circuit or closed circuit principle																						sel	sel	sel

Timing functions for tripping delay	1	2	3	4	5	6	7	8	9	10	11	12	13	14	15	16	17	18	19	20	21	22			
ON delay, 0.1 - 30 s											adj	adj	adj	adj	adj	adj	adj	adj	adj	adj	adj	adj	adj		
ON or OFF delay, 0.1 - 30 s																							sel	sel	sel

Output	1	2	3	4	5	6	7	8	9	10	11	12	13	14	15	16	17	18	19	20	21	22	
c/o contact	1	1	1	1	1	1	1	1	1	2	2	2	2	2	2	2	2	2	2	2	2	2	2

Connection type	1	2	3	4	5	6	7	8	9	10	11	12	13	14	15	16	17	18	19	20	21	22	
Push-in terminals		■		■		■		■		■		■		■		■		■		■		■	
Double-chamber cage connection terminals	■		■		■		■		■		■		■		■		■		■		■		■

adj: adjustable
sel: selectable

Current and voltage monitoring relays, single-phase

Ordering details - Current monitoring relays



CM-SRS.22S

2CDC 251 054 V0011



CM-SFS.22P

2CDC 251 056 V0011

Description

The CM range current monitoring relays protect single-phase mains (DC or AC) from over- and undercurrent from 3 mA to 15 A.

Ordering details

Description	Type	Order code	Price 1 pce	Weight (1 pce) kg (lb)
CM-SRS.11S		1SVR730840R0200		0.145 (0.320)
		1SVR730841R0200		0.161 (0.355)
CM-SRS.11P		1SVR730841R1200		0.161 (0.355)
		1SVR740840R0200		0.137 (0.302)
CM-SRS.11P		1SVR740841R0200		0.153 (0.337)
		1SVR740841R1200		0.153 (0.337)
CM-SRS.12S		1SVR730840R0300		0.137 (0.302)
		1SVR730841R0300		0.168 (0.370)
CM-SRS.12S		1SVR730841R1300		0.168 (0.370)
		1SVR730840R0400		0.152 (0.335)
CM-SRS.21S		1SVR730841R0400		0.179 (0.395)
		1SVR730841R1400		0.179 (0.395)
CM-SRS.21P		1SVR740840R0400		0.141 (0.311)
		1SVR740841R0400		0.168 (0.370)
CM-SRS.21P		1SVR740841R1400		0.168 (0.370)
		1SVR730840R0500		0.144 (0.399)
CM-SRS.22S		1SVR730841R0500		0.181 (0.399)
		1SVR730841R1500		0.181 (0.399)
CM-SRS.M1S		1SVR730840R0600		0.153 (0.337)
CM-SRS.M1P		1SVR740840R0600		0.142 (0.313)
CM-SRS.M2S		1SVR730840R0700		0.155 (0.342)
CM-SFS.21S		1SVR730760R0400		0.150 (0.331)
CM-SFS.21P		1SVR740760R0400		0.139 (0.306)
CM-SFS.22S		1SVR730760R0500		0.158 (0.348)

See "Selection table - Current monitoring relays" on page 63.

S: screw connection
P: push-in connection



Further documentation single-phase monitoring relays on www.abb.com

Current and voltage monitoring relays, single-phase

Selection table - Voltage monitoring relays

2

Type	Order number	1SVR730830R0300	1SVR740830R0300	1SVR730831R0300	1SVR740831R0300	1SVR730831R1300	1SVR740831R1300	1SVR730830R0400	1SVR740830R0400	1SVR730831R0400	1SVR740831R0400	1SVR730831R1400	1SVR740831R1400	1SVR730830R0500	1SVR740830R0500	1SVR730750R0400	1SVR740750R0400
Rated control supply voltage U_s																	
24 - 240 V AC/DC		■	■					■	■					■	■	■	■
110 - 130 V AC				■	■					■	■						
220 - 240 V AC						■	■					■	■				
Measuring ranges AC/DC																	
3 - 30 V		■	■	■	■	■	■	■	■	■	■	■	■	■	■	■	■
6 - 60 V		■	■	■	■	■	■	■	■	■	■	■	■	■	■	■	■
30 - 300 V		■	■	■	■	■	■	■	■	■	■	■	■	■	■	■	■
60 - 600 V		■	■	■	■	■	■	■	■	■	■	■	■	■	■	■	■
Monitoring function																	
Over- or undervoltage		■	■	■	■	■	■	■	■	■	■	■	■	■	■	■	■
Windows voltage monitoring																■	■
Latching														sel	sel	sel	sel
Open circuit or closed circuit principle														sel	sel	sel	sel
Timing functions for tripping delay																	
ON delay, 0.1 - 30 s								adj	adj	adj	adj	adj	adj	adj	adj		
ON or OFF delay, 0.1 - 30 s																sel	sel
Output																	
c/o contact		1	1	1	1	1	1	2	2	2	2	2	2	2	2	2	2
Connection type																	
Push-in terminals			■		■		■		■		■		■		■		■
Double-chamber cage connection terminals		■		■		■		■		■		■		■		■	

adj: adjustable
sel: selectable

Current and voltage monitoring relays, single-phase

Ordering details - Voltage monitoring relays



CM-ESS.MP

2CDC 251 060 V0011



CM-EFS.2

2CDC 251 059 V0011

Description

The CM range voltage monitoring relays provide reliable monitoring of voltages as well as detection of phase loss in single-phase mains.

Ordering details

Description	Type	Order code	Price 1 pce	Weight (1 pce) kg (lb)
	CM-ESS.1S	1SVR730830R0300		0.135 (0.298)
		1SVR730831R0300		0.164 (0.362)
	CM-ESS.1P	1SVR730831R1300		0.164 (0.362)
		1SVR740830R0300		0.126 (0.278)
	CM-ESS.1P	1SVR740831R0300		0.155 (0.342)
		1SVR740831R1300		0.155 (0.342)
	CM-ESS.2S	1SVR730830R0400		0.153 (0.337)
		1SVR730831R0400		0.181 (0.399)
	CM-ESS.2S	1SVR730831R1400		0.181 (0.399)
		1SVR740830R0400		0.142 (0.313)
	CM-ESS.2P	1SVR740831R0400		0.170 (0.375)
		1SVR740831R1400		0.170 (0.375)
	CM-ESS.MS	1SVR730830R0500		0.154 (0.340)
	CM-ESS.MP	1SVR740830R0500		0.143 (0.320)
	CM-EFS.2S	1SVR730750R0400		0.157 (0.346)
	CM-EFS.2P	1SVR740750R0400		0.146 (0.322)

See "Selection table - Voltage monitoring relays" on page 65.

S: screw connection
P: push-in connection



Further documentation single-phase monitoring relays on www.abb.com

Current and voltage monitoring relays, single-phase Function diagrams

Function diagrams - CM-SRS.1

Overcurrent monitoring

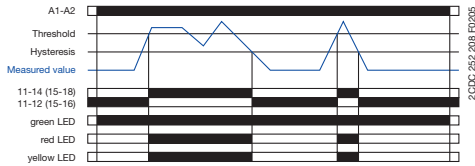

Undercurrent monitoring

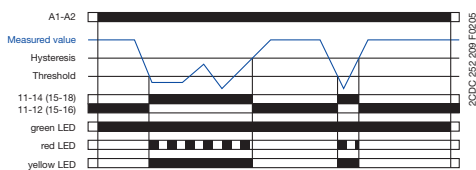

Function diagrams - CM-SRS.2

Overcurrent monitoring

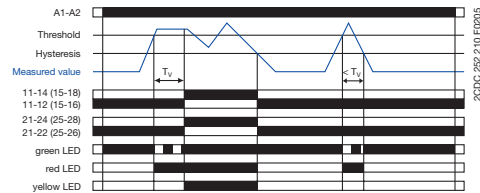

Undercurrent monitoring

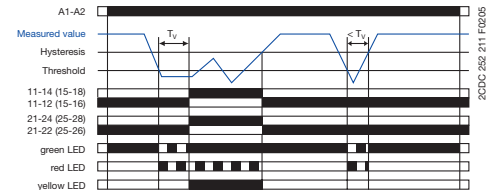

If the measured value exceeds resp. drops below the adjusted threshold value, the output relay(s) energize(s): on the CM-SRS.1 immediately, on the CM-SRS.2 after the set tripping delay T_V . If the measured value exceeds resp. drops below the threshold value plus resp. minus the adjusted hysteresis, the output relay(s) de-energize(s). The hysteresis is adjustable within a range of 3-30 % of the threshold value.

Function diagrams - CM-SRS.M

Overcurrent monitoring without latching

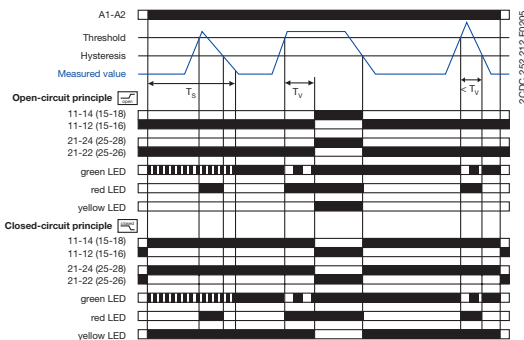

Undercurrent monitoring without latching

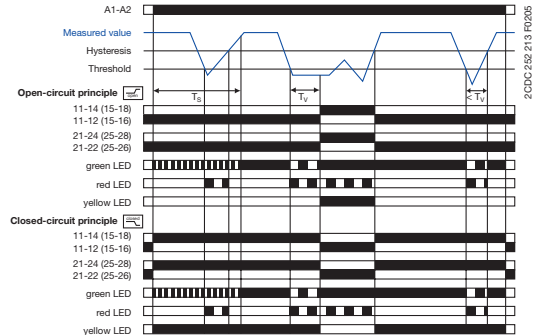

Overcurrent monitoring with latching

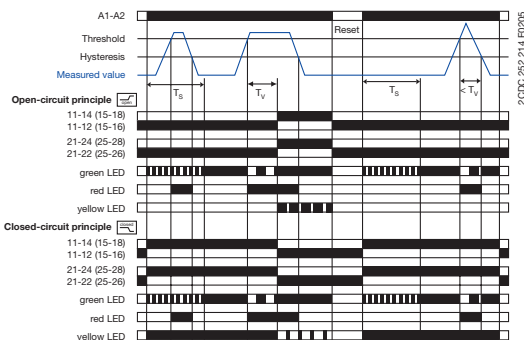

Undercurrent monitoring with latching

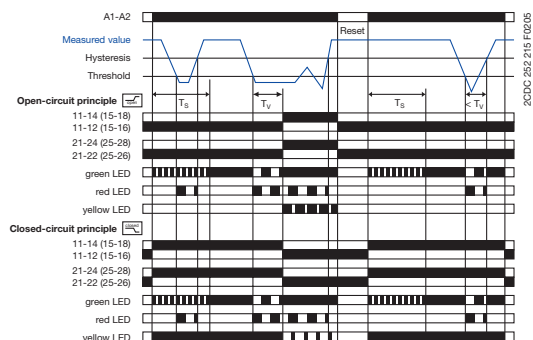

If the measured value exceeds resp. drops below the adjusted threshold value before the set start-up delay T_S is complete, the output relays do not change their actual state. If the measured value exceeds resp. drops below the adjusted threshold value when T_S is complete, the tripping delay T_V starts. If T_V is complete and the measured value is still exceeding resp. below the threshold value plus resp. minus the set hysteresis, the output relays energize / de-energize .

If the measured value exceeds resp. drops below the threshold value minus resp. plus the set hysteresis and the latching function is not activated , the output relays de-energize / energize . With activated latching function the output relays remain energized and de-energize only, when the supply voltage is interrupted / the output relays remain de-energized and energize only, when the supply voltage is switched off and then again switched on = Reset.

The hysteresis is adjustable within a range of 3-30 % of the threshold value.

Current and voltage monitoring relays, single-phase

Function diagrams

Function diagrams - CM-SFS.2

Current window monitoring 1x2 c/o contact
ON-delayed without latching

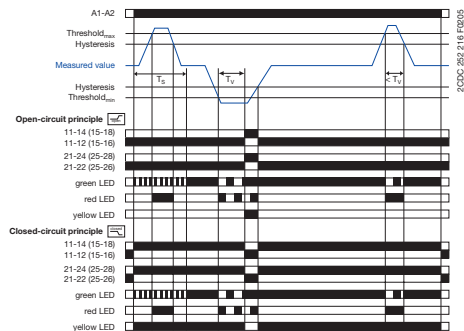

Further function diagrams see data sheet.

ON-delayed current window monitoring with parallel switching c/o contacts :

If the measured value exceeds resp. drops below the adjusted threshold value before the set start-up delay T_S is complete, the output relays do not change their actual state.

If the measured value exceeds resp. drops below the adjusted threshold value when T_S is complete, the tripping delay T_V starts, when is configured. If T_V is complete and the measured value is still exceeding resp. below the threshold value minus resp. plus the fixed hysteresis (5%), the output relays energize /de-energize .

If the measured value exceeds resp. drops below the threshold value plus resp. minus the hysteresis and the latching function is not activated , the output relays de-energize / energize . With activated latching function the output relays remain energized and de-energize only, when the supply voltage is interrupted / the output relays remain de-energized and energize only, when the supply voltage is switched off and then again switched on = Reset.

Current window monitoring 1x2 c/o contact
OFF-delayed without latching

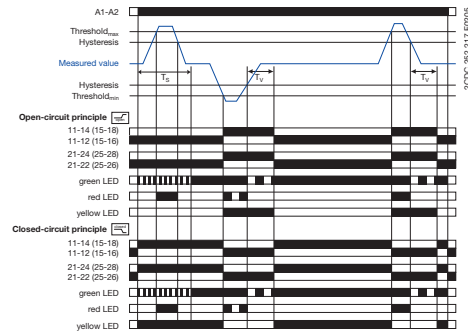

OFF-delayed current window monitoring with parallel switching c/o contacts :

If the measured value exceeds resp. drops below the adjusted threshold value when the set start-up delay T_S is complete, the output relays energize / de-energize , when is configured, and remain in this position during the set tripping delay T_V . If the measured value exceeds resp. drops below the threshold value plus resp. minus the fixed hysteresis (5%) and the latching function is not activated , the tripping delay T_V starts. After completion of T_V , the output relays de-energize / energize , provided that the latching function is not activated . With activated latching function the output relays remain energized and de-energize only, when the supply voltage is interrupted / the output relays remain de-energized and energize only, when the supply voltage is switched off and then again switched on = Reset. When is adjusted on the device, the functionality is equivalent to the one described above. There is only to consider that in this case, instead of both output relays, only one output relay each will be switched.

$$">" = 11_{15} - 12_{16} / 14_{18}; \quad "<" = 21_{25} - 22_{26} / 24_{28}$$

Function diagrams - CM-ESS.1

Overvoltage monitoring

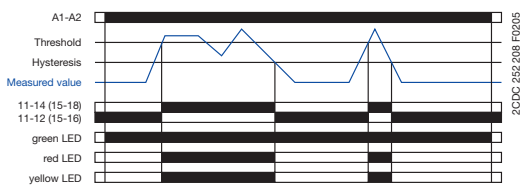

Undervoltage monitoring

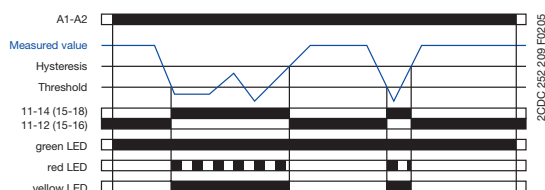

Function diagrams - CM-ESS.2

Overvoltage monitoring

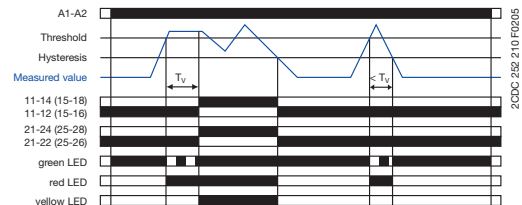

Undervoltage monitoring

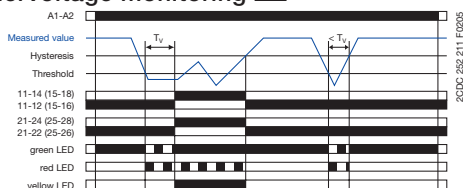

Depending on the configuration, the voltage monitoring relays CM-ESS.1 and CM-ESS.2 can be used for over- or undervoltage monitoring in single-phase AC and/or DC systems. The voltage to be monitored (measured value) is applied to terminals B-C. The devices work according the open-circuit principle. If the measured value exceeds resp. drops below the adjusted threshold value, the output relay(s) energize(s): on the CM-ESS.1 immediately, on the CM-ESS.2 after the set tripping delay T_V . If the measured value exceeds resp. drops below the threshold value plus resp. minus the adjusted hysteresis, the output relay(s) de-energize(s). The hysteresis is adjustable within a range of 3-30 % of the threshold value.

Current and voltage monitoring relays, single-phase

Function diagrams

Function diagrams - CM-ESS.M

Overvoltage monitoring without latching

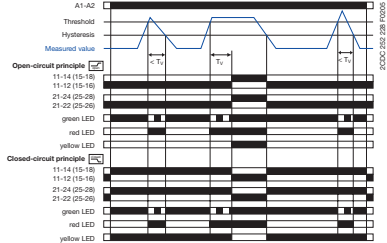

Undervoltage monitoring without latching

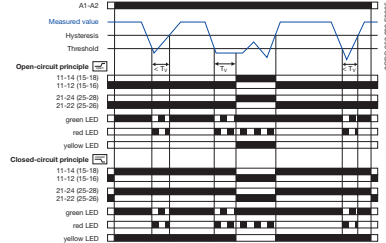



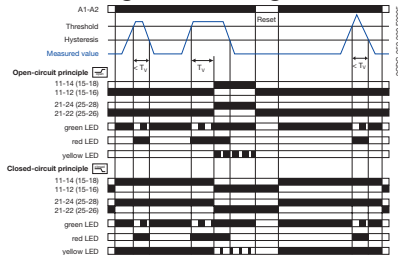



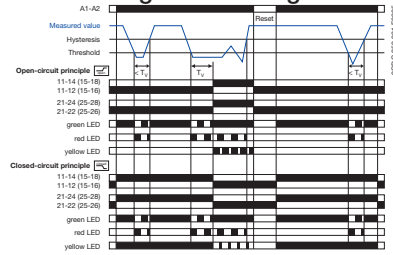

Overvoltage monitoring with latching



Undervoltage monitoring without latching



If the measured value exceeds resp. drops below the adjusted threshold value, the tripping delay T_V starts. If T_V is complete and the measured value is still exceeding resp. below the threshold value plus resp. minus the set hysteresis, the output relays energize  / de-energize .

If the measured value exceeds resp. drops below the threshold value plus resp. minus the set hysteresis and the latching function is not activated , the output relays de-energize  / energize . With activated latching function  the output relays remain energized  and de-energize only, when the supply voltage is interrupted / the output relays remain de-energized  and energize only, when the supply voltage is switched off and then again switched on = Reset. The hysteresis is adjustable within a range of 3-30 % of the threshold value.



Further function diagrams see data sheet.



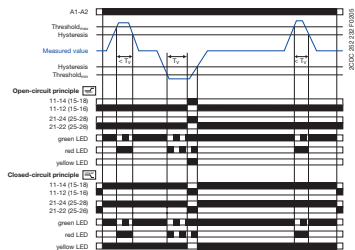



Voltage window monitoring 1x2 c/o contact

ON-delayed without latching



ON-delayed voltage window monitoring with parallel switching c/o contacts

If the measured value exceeds resp. drops below the adjusted threshold value, the tripping delay T_V starts, when  is configured. If T_V is complete and the measured value is still exceeding resp. below the threshold value minus resp. plus the fixed hysteresis (5%), the output relays energize  / de-energize .



If the measured value exceeds resp. drops below the threshold value plus resp. minus the hysteresis and the latching function is not activated , the output relays de-energize  / energize . With activated latching function  the output relays remain energized  and de-energize only, when the supply voltage is interrupted / the output relays remain de-energized  and energize only, when the supply voltage is switched off and then again switched on = Reset.



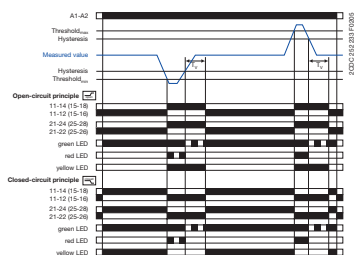



Voltage window monitoring 1x2 c/o contact

OFF-delayed without latching



OFF-delayed voltage window monitoring with parallel switching c/o contacts

If the measured value exceeds resp. drops below the adjusted threshold value, the output relays energize  / de-energize , when  is configured, and remain in this position during the set tripping delay T_V .

If the measured value exceeds resp. drops below the threshold value plus resp. minus the fixed hysteresis (5%) and the latching function is not activated , the tripping delay T_V starts. After completion of T_V , the output relays de-energize  / energize , provided that the latching function is not activated . With activated latching function  the output relays remain energized  and de-energize only, when the supply voltage is interrupted / the output relays remain de-energized  and energize only, when the supply voltage is switched off and then again switched on = Reset.

When  is adjusted on the device, the functionality is equivalent to the one described above. There is only to consider that in this case, instead of both output relays, only one output relay each will be switched.

">U" = 11₁₅-12₁₆/14₁₈; "<U" = 21₂₅-22₂₆/24₂₈

Current and voltage monitoring relays, single-phase

Connection diagrams, DIP switches

Connection diagram CM-SRS.1, CM-SRS.2

A1	11 ₁₅	C
B1	B2	B3

A1	11 ₁₅	21 ₂₅
B1	B2	B3

2CDC 252 204 F0005 2CDC 252 205 F0005

A1-A2 Control supply voltage
 B1-C Measuring range 1: 3-30 mA or 0.3-1.5 A
 B2-C Measuring range 2: 10-100 mA or 1-5 A
 B3-C Measuring range 3: 0.1-1 A or 3-15 A
 11₁₅-12₁₆/14₁₈ Output contacts - open-circuit principle
 21₂₅-22₂₆/24₂₈

DIP switch functions CM-SRS.1, CM-SRS.2

Position	2	1
ON ↑		
OFF		

2CDC 252 272 F0005

1 ON Undercurrent monitoring
 OFF Overcurrent monitoring

OFF = Default

Connection diagram CM-SRS.M

A1	11 ₁₅	21 ₂₅
B1	B2	B3

A1	11 ₁₅	21 ₂₅
B1	B2	B3

2CDC 252 205 F0005

A1-A2 Control supply voltage
 B1-C Measuring range 1: 3-30 mA or 0.3-1.5 A
 B2-C Measuring range 2: 10-100 mA or 1-5 A
 B3-C Measuring range 3: 0.1-1 A or 3-15 A
 11₁₅-12₁₆/14₁₈ Output contacts - open- or
 21₂₅-22₂₆/24₂₈ closed circuit principle

DIP switch functions CM-SRS.M

Position	4	3	2	1
ON ↑				
OFF				

2CDC 252 273 F0005

1 ON Undercurrent monitoring
 OFF Overcurrent monitoring
 2 ON Closed-circuit principle
 OFF Open-circuit principle
 3 ON Latching function activated
 OFF Latching function not activated
 OFF = Default

Connection diagram CM-SFS.2

A1	11 ₁₅	21 ₂₅
B1	B2	B3

A1	11 ₁₅	21 ₂₅
B1	B2	B3

2CDC 252 205 F0005

A1-A2 Control supply voltage
 B1-C Measuring range 1: 3-30 mA or 0.3-1.5 A
 B2-C Measuring range 2: 10-100 mA or 1-5 A
 B3-C Measuring range 3: 0.1-1 A or 3-15 A
 11₁₅-12₁₆/14₁₈ Output contacts - open- or
 21₂₅-22₂₆/24₂₈ closed circuit principle

DIP switch function CM-SFS.2

Position	4	3	2	1
ON ↑				
OFF				

2CDC 252 274 F0005

1 ON OFF-delay
 OFF ON-delay
 2 ON Closed-circuit principle
 OFF Open-circuit principle
 3 ON Latching function activated
 OFF Latching function not activated
 4 ON 2x1 c/o contact
 OFF 1x2 c/o contacts
 OFF = Default

Connection diagram CM-ESS.M

A1	11 ₁₅	21 ₂₅
B		

A1	11 ₁₅	21 ₂₅
B		

2CDC 252 207 F0005

A1-A2 Control supply voltage
 B-C Measuring ranges AC/DC:
 3-30 V; 6-60 V
 30-300 V; 60-600 V
 11₁₅-12₁₆/14₁₈ Output contacts - open- or
 21₂₅-22₂₆/24₂₈ closed circuit principle

DIP switch functions CM-ESS.M

Position	4	3	2	1
ON ↑				
OFF				

2CDC 252 276 F0005

1 ON Undervoltage monitoring
 OFF Overvoltage monitoring
 2 ON Closed-circuit principle
 OFF Open-circuit principle
 3 ON Latching function activated
 OFF Latching function not activated
 OFF = Default

Current and voltage monitoring relays, single-phase

Connection diagrams, DIP switches

2

Connection diagram CM-ESS.1, CM-ESS.2

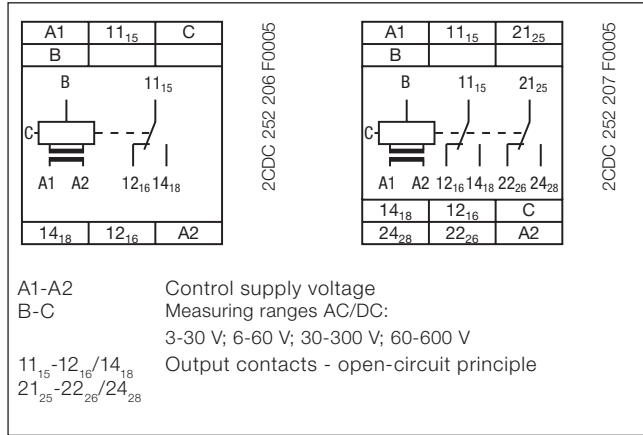

DIP switch functions CM-ESS.1, CM-ESS.2

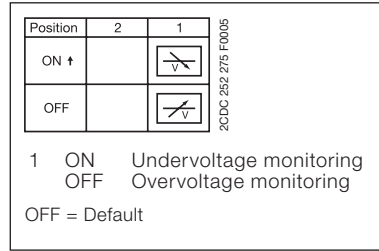

Connection diagram CM-EFS.2

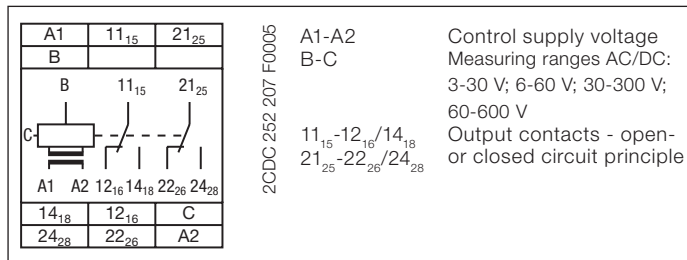



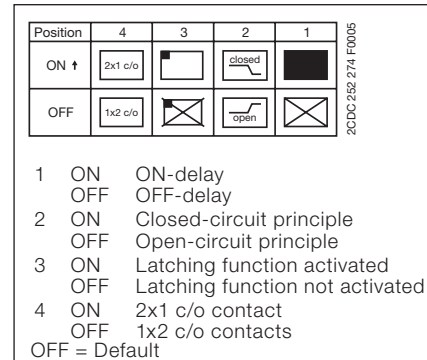





DIP switch functions CM-EFS.2







Current monitoring relays, single-phase

Technical data - Current monitoring relays

2

Type		CM-SRS.1	CM-SRS.2	CM-SRS.M	CM-SFS.2	
Input circuit - Supply circuit		A1-A2				
Rated control supply voltage U_s	A1-A2	110-130 V AC				
	A1-A2	220-240 V AC				
	A1-A2	24-240 V AC/DC				
Rated control supply voltage U_s tolerance		-15...+10 %				
Rated frequency	AC versions	50/60 Hz				
	AC/DC versions	50/60 Hz or DC				
Current / power consumption		see data sheets				
Power failure buffering time		20 ms				
Transient overvoltage protection		Varistors				
Input circuit - Measuring circuit		B1/B2/B3-C				
Monitoring function		over- or undercurrent monitoring configurable			over- and under- current monitoring	
Measuring method		True RMS measuring principle				
Measuring inputs		CM-SxS.x1			CM-SxS.x2	
	Terminal connection	B1-C	B2-C	B3-C	B1-C	B2-C
	Measuring ranges AC/DC	3-30 mA	10-100 mA	0.1-1 A	0.3-1.5 A	1-5 A
	Input resistance	3.3 Ω	1 Ω	0.1 Ω	0.05 Ω	0.01 Ω
	Pulse overload capacity $t < 1$ s	500 mA	1 A	10 A	15 A	50 A
	Continuous capacity	50 mA	150 mA	1.5 A	2 A	17 A
Threshold value(s)		adjustable within the indicated measuring range				
Setting accuracy of threshold value		10 %				
Hysteresis related to the threshold value		3-30 % adjustable				
Measuring signal frequency range		DC / 15 Hz - 2 kHz				
Rated measuring signal frequency range		DC / 50-60 Hz				
Maximum response time		AC: 80 ms / DC: 120 ms				
Accuracy within the control supply voltage tolerance		$\Delta U \leq 0.5$ %				
Accuracy within the temperature range		$\Delta U \leq 0.06$ % / °C				
Timing circuit						
Start-up delay T_s		none	0 or 0.1-30 s adjustable			
Tripping delay T_v		none	0 or 0.1-30 s adjustable			
Repeat accuracy (constant parameters)		± 0.07 % of full scale				
Accuracy within the control supply voltage tolerance		-	$\Delta t \leq 0.5$ %			
Accuracy within the temperature range		-	$\Delta t \leq 0.06$ % / °C			
Indication of operational states						
Control supply voltage	U/T: green LED	 : control supply voltage applied,  : start-up delay T_s active,  : tripping delay T_v active				
Measured value	I: red LED	 : overcurrent,  : undercurrent				
Relay status	R: yellow LED	 : relay energized, no latching function  : relay energized, active latching function  : relay de-energized, active latching function				
Output circuits		11(15)-12(16)/14(18), 21(25)-22(26)/24(28) - Relays				
Kind of output		1 c/o contact	2 c/o contacts	1x2 c/o contacts or 2x1 c/o contact configurable		
Operating principle		open-circuit principle ¹⁾			open- or closed-circuit principle configurable ¹⁾	
Contact material		AgNi				
Rated operational voltage U_o	IEC/EN 60947-1	250 V				
Minimum switching voltage / minimum switching current		24 V / 10 mA				
Maximum switching voltage / maximum switching current		250 V AC / 4 A AC				
Rated operational current I_o	AC-12 (resistive) at 230 V	4 A				
(IEC/EN 60947-5-1)	AC-15 (inductive) at 230 V	3 A				
	DC-12 (resistive) at 24 V	4 A				
	DC-13 (inductive) at 24 V	2 A				
AC rating	Utilization category	B 300				
(UL 508)	(Control Circuit Rating Code)					
	max. rated operational voltage	300 V AC				
	max. continuous thermal current at B 300	5 A				
	max. making/breaking apparent power (Make/Break) at B 300	3600/360 VA				
Mechanical lifetime		30x10 ⁶ switching cycles				
Electrical lifetime (AC-12, 230 V, 4 A)		0.1x10 ⁶ switching cycles				
Max. fuse rating to achieve short-circuit protection	n/c contact	6 A fast-acting	10 A fast-acting	6 A fast-acting		
	n/o contact	10 A fast-acting				

¹⁾ Open-circuit principle: output relay energizes if the measured value exceeds  / falls below  the adjusted threshold value
 Closed-circuit principle: output relay de-energizes if measured value exceeds  / falls below  the adjusted threshold value

²⁾ In case of measured currents > 10 A, lateral spacing has to be min. 10 mm

Current monitoring relays, single-phase

Technical data - Current monitoring relays







2

Type	CM-SRS.1	CM-SRS.2	CM-SRS.M	CM-SFS.2
General data				
MTBF	on request			
Duty time	100%			
Dimensions (W x H x D)	product dimensions	22.5 x 85.6 x 103.7 mm (0.89 x 3.37 x 4.08 in)		
	packaging dimensions	97 x 109 x 30 mm (3.82 x 4.29 x 1.18 in)		
Weight	net weight	depending on device, see ordering details		
	gross weight	depending on device, see ordering details		
Mounting	DIN rail (IEC/EN 60715), snap-on mounting without any tool			
Mounting position	any			
Minimum distance to other units	10 mm (0.39 in) at measured current > 10 A ²⁾			
Material of housing	UL 94 V-0			
Degree of protection	housing / terminals	IP50 / IP20		
Electrical connection				
Wire size		Screw connection technology	Easy Connect Technology (Push-in)	
	fine-strand with(out) wire end ferrule	1 x 0.5-2.5 mm ² (1 x 20-14 AWG) 2 x 0.5-1.5 mm ² (2 x 20-16 AWG)	2 x 0.5-1.5 mm ² (2 x 20-16 AWG)	
	rigid	1 x 0.5-4 mm ² (1 x 20-12 AWG) 2 x 0.5-2.5 mm ² (2 x 20-14 AWG)	2 x 0.5-1.5 mm ² (2 x 20-16 AWG)	
Stripping length	8 mm (0.32 in)			
Tightening torque	0.6-0.8 Nm (5.31-7.08 lb.in)		-	
Environmental data				
Ambient temperature range	operation / storage	-20...+60 °C / -40...+85 °C		
Damp heat (IEC 60068-2-30)	55 °C, 6 cycles			
Vibration (sinusoidal) (IEC/EN 60255-21-1)	Class 2			
Shock (IEC/EN 60255-21-2)	Class 2			
Isolation data				
Rated insulation voltage (VDE 0110, IEC 60947-1, IEC/EN 60255-5)	supply / measuring circuit / output	600 V		
	supply / output 1/2	250 V		
Rated impulse withstand voltage U _{imp} (IEC/EN 60947-1, IEC/EN 60255-5)	supply /measuring circuit / output	6 kV 1.2/50 μs		
	supply / output 1/2	4 kV 1.2/50 μs		
Pollution degree (VDE 0110, IEC 664, IEC/EN 60255-5)	3			
Overvoltage category (VDE 0110, IEC 664, IEC/EN 60255-5)	III			
Standards				
Product standard	IEC/EN 60255-1, IEC/EN 60255-27, EN 50178			
Low Voltage Directive	2006/95/EC			
EMC Directive	2004/108/EC			
Electromagnetic compatibility				
Interference immunity to	IEC/EN 61000-6-2			
electrostatic discharge	IEC/EN 61000-4-2	Level 3		
radiated, radio-frequency, electromagnetic field	IEC/EN 61000-4-3	Level 3		
electrical fast transient / burst	IEC/EN 61000-4-4	Level 3		
surge	IEC/EN 61000-4-5	Level 3		
conducted disturbances, induced by radio-frequency fields	IEC/EN 61000-4-6	Level 3		
Interference emission	IEC/EN 61000-6-3			
high-frequency radiated	IEC/CISPR 22; EN 55022	Class B		
high-frequency conducted	IEC/CISPR 22; EN 55022	Class B		

Voltage monitoring relays, single-phase

Technical data - Voltage monitoring relays





2

Type		CM-ESS.1	CM-ESS.2	CM-ESS.M	CM-EFS.2
Input circuit - Supply circuit		A1-A2			
Rated control supply voltage U_s	A1-A2	110-130 V AC			
	A1-A2	220-240 V AC			
	A1-A2	24-240 V AC/DC			
Rated control supply voltage U_s tolerance		-15...+10 %			
Rated frequency	AC versions	50/60 Hz			
	AC/DC versions	50/60 Hz or DC			
Current / power consumption		see data sheet			
Power failure buffering time		20 ms			
Transient overvoltage protection		Varistors			
Input circuit - Measuring circuit		B-C			
Monitoring function		over- or undervoltage monitoring configurable			over- and undervoltage monitoring configurable
Measuring method		True RMS measuring principle			
Measuring inputs		CM-ExS			
	Terminal connection	B-C	B-C	B-C	B-C
	Measuring range AC/DC	3-30 V	6-60 V	30-300 V	60-600 V
	Input resistance	600 k Ω	600 k Ω	600 k Ω	600 k Ω
	Pulse overload capacity $t < 1$ s	800 V	800 V	800 V	800 V
	Continuous capacity	660 V	660 V	660 V	660 V
Threshold value(s)		adjustable within the indicated measuring range			
Setting accuracy of threshold value		10 %			
Hysteresis related to the threshold value		3-30 % adjustable			5 % fixed
Measuring signal frequency range		DC / 15 Hz - 2 kHz			
Rated measuring signal frequency range		DC / 50-60 Hz			
Maximum response time		AC: 80 ms / DC: 120 ms			
Accuracy within the control supply voltage tolerance		$\Delta U \leq 0.5$ %			
Accuracy within the temperature range		$\Delta U \leq 0.06$ % / °C			
Transient overvoltage protection		Varistors			
Timing circuit					
Delay time T_v		none	0 or 0.1-30 s adjustable		
Repeat accuracy (constant parameters)		± 0.07 % of full scale			
Accuracy within the control supply voltage tolerance		-	$\Delta t \leq 0.5$ %		
Accuracy within the temperature range		-	$\Delta t \leq 0.06$ % / °C		
Indication of operational states					
Control supply voltage	U/T: green LED	 : control supply voltage applied  : tripping delay T_v active			
Measured value	U: red LED	 : overvoltage,  : undervoltage			
Relay status	R: yellow LED	 : relay energized, no latching function  : relay energized, active latching function  : relay de-energized, active latching function			
Output circuits					
Kind of output		1 c/o contact	2 c/o contacts	1x2 c/o contacts or 2x1 c/o contact configurable	
Operating principle		open-circuit principle ¹⁾		open- or closed-circuit principle configurable ¹⁾	
Contact material		AgNi			
Rated operational voltage U_o	IEC/EN 60947-1	250 V			
Minimum switching voltage / minimum switching current		24 V / 10 mA			
Maximum switching voltage / maximum switching current		250 V AC / 4 A AC			
Rated operational current I_o (IEC/EN 60947-5-1)	AC-12 (resistive) at 230 V	4 A			
	AC-15 (inductive) at 230 V	3 A			
	DC-12 (resistive) at 24 V	4 A			
	DC-13 (inductive) at 24 V	2 A			
AC rating (UL 508)	Utilization category (Control Circuit Rating Code)	B 300			
	max. rated operational voltage	300 V AC			
	max. continuous thermal current at B 300	5 A			
	max. making/breaking apparent power (Make/Break) at B 300	3600/360 VA			
Mechanical lifetime		30x10 ⁶ switching cycles			
Electrical lifetime	AC-12, 230 V, 4 A	0.1x10 ⁶ switching cycles			
Max. fuse rating to achieve short-circuit protection	n/c contact	6 A fast-acting		10 A fast-acting	
	n/o contact	10 A fast-acting		6 A fast-acting	

Voltage monitoring relays, single-phase

Technical data - Voltage monitoring relays

Type	CM-ESS.1	CM-ESS.2	CM-ESS.M	CM-EFS.2
General data				
MTBF	on request			
Duty time	100%			
Dimensions (W x H x D)	product dimensions	22.5 x 85.6 x 103.7 mm (0.89 x 3.37 x 4.08 in)		
	packaging dimensions	97 x 109 x 30 mm (3.82 x 4.29 x 1.18 in)		
Weight	net weight	depending on device, see ordering details		
	gross weight	depending on device, see ordering details		
		DIN rail (IEC/EN 60715), snap-on mounting without any tool		
Mounting position	any			
Minimum distance to other units	vertical / horizontal	not necessary / not necessary		
Material of housing	UL 94 V-0			
Degree of protection	housing / terminals	IP50 / IP20		
Environmental data				
Ambient temperature ranges	operation	-20...+60 °C		
	storage	-40...+85 °C		
Damp heat, cyclic (IEC/EN 60068-2-30)	55 °C, 6 cycle			
Vibration, sinusoidal (IEC/EN 60255-21-1)	Class 2			
Shock (IEC/EN 60255-21-2)	Class 2			
Electrical connection				
Wire size		Screw connection technology	Easy Connect Technology (Push-in)	
	fine-strand with(out) wire end ferrule	1 x 0.5-2.5 mm ² (1 x 20-14 AWG) 2 x 0.5-1.5 mm ² (2 x 20-16 AWG)	2 x 0.5-1.5 mm ² (2 x 20-16 AWG)	
	rigid	1 x 0.5-4 mm ² (1 x 20-12 AWG) 2 x 0.5-2.5 mm ² (2 x 20-14 AWG)	2 x 0.5-1.5 mm ² (2 x 20-16 AWG)	
Stripping length	8 mm (0.32 in)			
Tightening torque	0.6-0.8 Nm (5.31-7.08 lb.in)		-	
Isolation data				
Rated insulation voltage (VDE 0110, IEC 60947-1, IEC/EN 60255-5)	supply / measuring circuit / output	600 V		
	supply / output 1/2	250 V		
Rated impulse withstand voltage U _{imp} (IEC/EN 60947-1, IEC/EN 60255-5)	supply / measuring circuit / output	6 kV 1.2/50 μs		
	supply / output 1/2	4 kV 1.2/50 μs		
Pollution degree (VDE 0110, IEC 664, IEC/EN 60255-5)	3			
Overvoltage category (VDE 0110, IEC 664, IEC/EN 60255-5)	III			
Standards				
Product standard	IEC/EN 60255-1, IEC/EN 60255-27, EN 50178			
Low Voltage Directive	2006/95/EC			
EMC Directive	2004/108/EC			
Electromagnetic compatibility				
Interference immunity to	IEC/EN 61000-6-2			
electrostatic discharge	IEC/EN 61000-4-2	Level 3		
radiated, radio-frequency, electromagnetic field	IEC/EN 61000-4-3	Level 3		
electrical fast transient / burst	IEC/EN 61000-4-4	Level 3		
surge	IEC/EN 61000-4-5	Level 3		
conducted disturbances, induced by radio-frequency fields	IEC/EN 61000-4-6	Level 3		
Interference emission	IEC/EN 61000-6-3			
high-frequency radiated	IEC/CISPR 22; EN 55022	Class B		
high-frequency conducted	IEC/CISPR 22; EN 55022	Class B		

1) Open-circuit principle: output relay energizes if the measured value exceeds  / falls below  the adjusted threshold value
 Closed-circuit principle: output relay de-energizes if measured value exceeds  / falls below  the adjusted threshold value

Current and voltage monitoring relays, single-phase

Notes

Three-phase monitoring relays

Product group picture

2



Three-phase monitoring relays

Table of contents

Three-phase monitoring relays

Three-phase monitoring relays	78
Benefits and advantages, Applications	79
Operating controls	80
Selection table - Singlefunctional	81
Ordering details - Singlefunctional	82
Selection table - Multifunctional	83
Ordering details - Multifunctional	84
Function diagrams	85
Connection diagrams	89
DIP switches, Rotary switches	90
Technical data	91

Three-phase monitoring relays

Benefits and advantages, Applications

2

Characteristics of the CM range three-phase monitors

- Adjustable phase unbalance threshold value ¹⁾
- Adjustable ON-delay/OFF-delay time ¹⁾
- Dual frequency measuring 50/60 Hz
- Powered by the measuring circuit
- 1 n/o contact, 1 or 2 c/o contacts
- LEDs for the indication of operational states
- Multifunctional and single-functional devices
- Phase failure detection
- Phase sequence monitoring ¹⁾
- Over- and undervoltage monitoring (fixed or adjustable)¹⁾
- Wide-range operating voltage guarantees world-wide operation
- Approvals / Marks

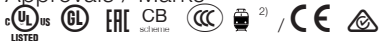

¹⁾ depending on device type

²⁾ Applicable in rail application following the latest standards for rail applications: NF F 16-101/102 (I2/F2 classified), EN 45545 (Hazard Level 3), DIN 5510, EN 50155, IEC 60571. Further information is available in our rail segment brochure 2CDC110084B0201.

Phase unbalance monitoring

If the supply by the three-phase system is unbalanced due to uneven distribution of the load, the motor will convert a part of the energy into reactive power. This energy gets lost unexploited; also the motor is exposed to higher thermal stress. Other thermal protection devices fail to detect continuing unbalances which can lead to damage or destruction of the motor. The CM range three-phase monitors with phase unbalance monitoring can reliably detect this critical situation.

Phase sequence

Changing the phase sequence during operation or a wrong phase sequence prior to startup causes a change of the rotational direction of the connected device. Generators, pumps or fans rotate in the wrong direction and the installation is no longer working properly. Especially for moveable equipment, such as construction machinery, phase sequence detection prior to the startup process is highly reasonable.

Phase loss

In case of phase loss, undefined states of the installation are likely to occur. E.g. the startup process of motors is disturbed. All three-phase monitors of the ABB CM range detect a phase loss as soon as the voltage of one phase drops below 60% of its nominal value.

Voltage monitoring

All electric devices can be damaged when operated continuously in a network with out-of-range voltages. For example, safe starting is not ensured in case of undervoltage. Also, the switching state of a contactor is not clearly defined when operated in a „forbidden“ voltage range. This can lead to undefined states of the installation and cause damage or destruction of valuable parts.

Extended functionality

ABB's new generation of three-phase monitoring relays feature additional functions making the application field for the devices considerably larger.

Selectable phase sequence monitoring

The phase sequence monitoring can be switched off by means of a rotary switch or a DIP switch. This enables monitoring of three-phase mains where phase sequence is not relevant for the application, for example in case of motors with forward and reverse rotation, heating applications, etc.

Automatic phase sequence correction

The automatic phase sequence correction is activated by means of a DIP switch. With activated phase sequence correction, it is ensured that for any non-fixed or portable equipment, e.g. construction machinery, the correct phase sequence is always applied to the input terminals of the load. For details regarding the wiring, please see function description / diagrams.

Structure of the type designation

CM-__ x.yz

x: width of enclosure

y: Control supply voltage / measuring range

1	110, 115, 120, 127 V supply systems (phase-neutral)
2	220, 230, 240 V supply systems (phase-neutral)
3	200, 208, 220, 230, 240, 257, 260 V supply systems (phase-phase)
4	440, 460 V supply systems (phase-phase)
5	480, 500 V supply systems (phase-phase)
6	575, 600 V supply systems (phase-phase)
7	660, 690 V supply systems (phase-phase)
8	200, 400 V supply systems (phase-phase)

z: Rated frequency / output circuit

1	50/60 Hz – 1x2 c/o
2	50/60 Hz – 1x2 or 2x1 c/o
3	50/60/400 Hz – 1x2 oder 2x1 c/o

Three-phase monitoring relays

Operating controls

S-Range Housing

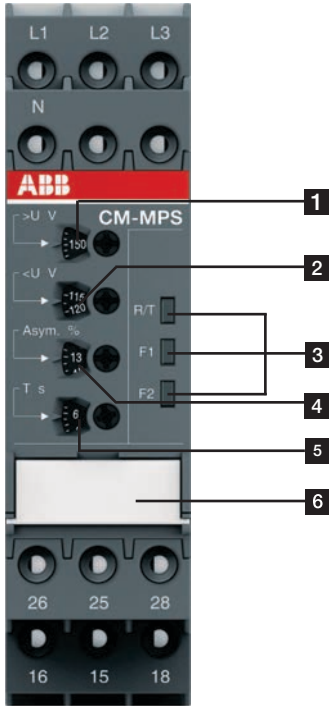

- 1** Adjustment of the hysteresis $>U$ for overvoltage
- 2** Adjustment of the threshold value $<U$ for undervoltage
- 3** Indication of operational states
 - R/T: red LED – Relay status / timing
 - F1: yellow LED – Fault message
 - F2: yellow LED – Fault message

- 4** Adjustment of the threshold value Asym. for phase unbalance
- 5** Adjustment of the tripping delay T_v
- 6** DIP switches (see DIP switch functions on page 2/40)
 - ON-delay
 - OFF-delay
 - Phase sequence monitoring deactivated
 - Phase sequence monitoring activated
 - Phase sequence correction activated
 - Phase sequence correction deactivated
 - 2x1 c/o (SPDT) contact
 - 1x2 c/o (SPDT) contacts

2CDC 283 017 F0013

N-Range Housing

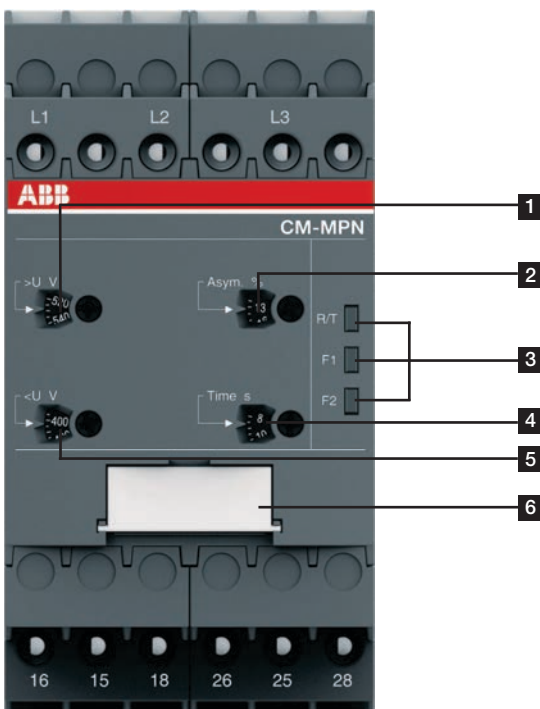

- 1** Adjustment of the hysteresis $>U$ for overvoltage
- 2** Adjustment of the threshold value Asym. for phase unbalance
- 3** Indication of operational states
 - R/T: red LED – Relay status / timing
 - F1: yellow LED – Fault message
 - F2: yellow LED – Fault message

- 4** Adjustment of the tripping delay T_v
- 5** Adjustment of the hysteresis $<U$ for undervoltage
- 6** DIP switches (see DIP switch functions on page 2/40)
 - ON-delay
 - OFF-delay
 - Phase sequence monitoring deactivated
 - Phase sequence monitoring activated
 - Phase sequence correction activated
 - Phase sequence correction deactivated
 - 2x1 c/o (SPDT) contact
 - 1x2 c/o (SPDT) contacts

2CDC 283 016 F0013

Three-phase monitoring relays

Selection table - Singlefunctional

2

	Type	Order number
	CM-PBE	1SVR550881R9400
	CM-PBE	1SVR550882R9500
	CM-PVE	1SVR550870R9400
	CM-PVE	1SVR550871R9500
	CM-PFE	1SVR550824R9100
	CM-PFS.S	1SVR730824R9300
	CM-PFS.P	1SVR740824R9300
	CM-PSS.31S	1SVR730784R2300
	CM-PSS.31P	1SVR740784R2300
	CM-PSS.41S	1SVR730784R3300
	CM-PSS.41P	1SVR740784R3300
	CM-PVS.31S	1SVR730794R1300
	CM-PVS.31P	1SVR730794R1300
	CM-PVS.41S	1SVR730794R3300
	CM-PVS.41P	1SVR740794R3300
	CM-PVS.81S	1SVR730794R2300
	CM-PVS.81P	1SVR740794R2300
	CM-PAS.31S	1SVR730774R1300
	CM-PAS.31P	1SVR740774R1300
	CM-PAS.41S	1SVR730774R3300
	CM-PAS.41P	1SVR740774R3300
Rated control supply voltage U_c		
Phase to phase		
160-300 V AC		■ ■
200-400 V AC		■ ■
200-500 V AC		■ ■
208-440 V AC		■ ■
300-500 V AC		■ ■
320-460 V AC		■ ■
380 V AC	■ ■	■ ■
380-440 V AC	■ ■	■ ■
400 V AC	■ ■	■ ■
Phase to Neutral		
185-265 V AC		■ ■
220-240 V AC	■ ■	■ ■
Rated frequency		
50/60 Hz	■ ■	■ ■
Suitable for monitoring		
Single-phase mains	■ ■	■ ■
Three-phase mains	■ ■	■ ■
Monitoring function		
Phase failure	■ ■	■ ■
Phase sequence		sel sel sel sel sel sel sel sel
Automatic phase sequence correction		
Overvoltage		■ ■
Undervoltage		■ ■
Unbalance		■ ■
Neutral ¹⁾	■ ■	■ ■
Thresholds	fix fix	fix fix
Timing functions for tripping delay		
ON delay		fix fix
On and OFF delay	fix fix	fix fix
Connection type		
Push-in terminals		■ ■
Double-chamber cage connection terminals		■ ■

¹⁾ The external conductor voltage towards the neutral conductor is measured.

adj: adjustable
 sel: selectable
 fix: fixed

Three-phase monitoring relays

Ordering details - Singlefunctional



2CDC 251 064 V0011

CM-PBE



2CDC 251 064 V0011

CM-PSS.41P



2CDC 251 063 V0011

CM-PAS.31P

Description

The three-phase monitoring relays are designed for use in three-phase mains for monitoring the phase parameters like phase sequence, phase failure, over- and undervoltage as well as phase unbalance.

Ordering details

Characteristics	Type	Order code	Price 1 pce	Weight (1 pce) kg (lb)
See "Selection table - Singlefunctional" on page 81.	CM-PBE	1SVR550881R9400		0.08 (0.17)
	CM-PBE	1SVR550882R9500		0.08 (0.17)
	CM-PVE	1SVR550870R9400		0.08 (0.17)
	CM-PVE	1SVR550871R9500		0.08 (0.17)
	CM-PFE	1SVR550824R9100		0.08 (0.17)
	CM-PFE.2	1SVR550826R9100		0.067 (0.147)

Ordering details

Characteristics	Type	Order code	Price 1 pce	Weight (1 pce) kg (lb)
See "Selection table - Singlefunctional" on page 81.	CM-PFS.S	1SVR730824R9300		0.127 (0.280)
	CM-PFS.P	1SVR740824R9300		0.119 (0.262)
	CM-PSS.31S	1SVR730784R2300		0.132 (0.291)
	CM-PSS.31P	1SVR740784R2300		0.123 (0.271)
	CM-PSS.41S	1SVR730784R3300		0.132 (0.291)
	CM-PSS.41P	1SVR740784R3300		0.123 (0.271)
	CM-PVS.31S	1SVR730794R1300		0.141 (0.311)
	CM-PVS.31P	1SVR740794R1300		0.132 (0.291)
	CM-PVS.41S	1SVR730794R3300		0.139 (0.306)
	CM-PVS.41P	1SVR740794R3300		0.131 (0.289)
	CM-PVS.81S	1SVR730794R2300		0.136 (0.300)
	CM-PVS.81P	1SVR740794R2300		0.128 (0.282)
	CM-PAS.31S	1SVR730774R1300		0.133 (0.293)
	CM-PAS.31P	1SVR740774R1300		0.124 (0.273)
	CM-PAS.41S	1SVR730774R3300		0.132 (0.291)
	CM-PAS.41P	1SVR740774R3300		0.123 (0.271)

S: screw connection
P: push-in connection



Further documentation three-phase monitoring relays on www.abb.com

Three-phase monitoring relays

Selection table - Multifunctional

2

	Order number																																										
Rated control supply voltage U_c	Type	CM-MPS.11S	1SVR730885R1300	CM-MPS.11P	1SVR740885R1300	CM-MPS.21S	1SVR730885R3300	CM-MPS.21P	1SVR740885R3300	CM-MPS.31S	1SVR730884R1300	CM-MPS.31P	1SVR740884R1300	CM-MPS.41S	1SVR730884R3300	CM-MPS.41P	1SVR740884R3300	CM-MPS.23S	1SVR730885R4300	CM-MPS.23P	1SVR740885R4300	CM-MPS.43S	1SVR730884R4300	CM-MPS.43P	1SVR740884R4300	CM-MPN.52S	1SVR750487R8300	CM-MPN.52P	1SVR760487R8300	CM-MPN.62S	1SVR750488R8300	CM-MPN.62P	1SVR760488R8300	CM-MPN.72S	1SVR750489R8300	CM-MPN.72P	1SVR760489R8300						
Phase to Phase																																											
160-300 V AC											■	■																															
300-500 V AC												■	■																														
350-580 V AC																																											
450-720 V AC																																											
530-820 V AC																																											
Phase to Neutral																																											
90-170 V AC		■	■																																								
180-280 V AC						■	■													■	■																						
Rated frequency																																											
50/60 Hz		■	■	■	■	■	■	■	■	■	■	■	■																														
50/60/400 Hz																					■	■	■	■																			
Suitable for monitoring																																											
Single-phase mains		■	■	■	■																■	■																					
Three-phase mains		■	■	■	■	■	■	■	■	■	■	■	■	■	■	■	■	■	■	■	■	■	■	■	■	■	■	■	■	■	■	■	■	■	■	■	■	■	■	■	■	■	
Monitoring function																																											
Phase failure		■	■	■	■	■	■	■	■	■	■	■	■	■	■	■	■	■	■	■	■	■	■	■	■	■	■	■	■	■	■	■	■	■	■	■	■	■	■	■	■	■	
Phase sequence		sel	sel	sel	sel	sel	sel	sel	sel	sel	sel	sel	sel	adj	adj	adj	adj	adj	adj	adj	adj	adj	adj	adj	adj	adj	adj	adj	adj	adj	adj	adj	adj	adj	adj	adj	adj	adj	adj	adj	adj		
Automatic phase sequence correction																					adj	adj	adj	adj	adj	adj	adj	adj	adj	adj	adj	adj	adj	adj	adj	adj	adj	adj	adj	adj	adj		
Overtoltage		■	■	■	■	■	■	■	■	■	■	■	■	■	■	■	■	■	■	■	■	■	■	■	■	■	■	■	■	■	■	■	■	■	■	■	■	■	■	■	■	■	■
Undervoltage		■	■	■	■	■	■	■	■	■	■	■	■	■	■	■	■	■	■	■	■	■	■	■	■	■	■	■	■	■	■	■	■	■	■	■	■	■	■	■	■	■	■
Unbalance		■	■	■	■	■	■	■	■	■	■	■	■	■	■	■	■	■	■	■	■	■	■	■	■	■	■	■	■	■	■	■	■	■	■	■	■	■	■	■	■	■	■
Neutral ¹⁾		■ ²⁾	■ ²⁾	■ ²⁾	■ ²⁾									■ ²⁾	■ ²⁾																												
Thresholds		adj	adj	adj	adj	adj	adj	adj	adj	adj	adj	adj	adj	adj	adj	adj	adj	adj	adj	adj	adj	adj	adj	adj	adj	adj	adj	adj	adj	adj	adj	adj	adj	adj	adj	adj	adj	adj	adj	adj	adj		
Timing functions for tripping delay																																											
On and OFF delay		adj	adj	adj	adj	adj	adj	adj	adj	adj	adj	adj	adj	adj	adj	adj	adj	adj	adj	adj	adj	adj	adj	adj	adj	adj	adj	adj	adj	adj	adj	adj	adj	adj	adj	adj	adj	adj	adj	adj	adj	adj	
Connection type																																											
Push-in terminals		■	■	■	■	■	■	■	■	■	■	■	■	■	■	■	■	■	■	■	■	■	■	■	■	■	■	■	■	■	■	■	■	■	■	■	■	■	■	■	■	■	■
Double-chamber cage connection terminals		■	■	■	■	■	■	■	■	■	■	■	■	■	■	■	■	■	■	■	■	■	■	■	■	■	■	■	■	■	■	■	■	■	■	■	■	■	■	■	■	■	■

1) The external conductor voltage towards the neutral conductor is measured.
 2) Interrupted neutral monitoring

adj: adjustable
 sel: selectable

Three-phase monitoring relays

Ordering details - Multifunctional



CM-MPS.23P

2CDC 251 065 V0011



CM-MPN.52P

2CDC 251 062 V0011

Ordering details

Characteristics	Type	Order code	Price 1 pce	Weight (1 pce) kg (lb)
	CM-MPS.11S	1SVR730885R1300		0.148 (0.326)
	CM-MPS.11P	1SVR740885R1300		0.137 (0.302)
	CM-MPS.21S	1SVR730885R3300		0.146 (0.322)
	CM-MPS.21P	1SVR740885R3300		0.135 (0.298)
	CM-MPS.31S	1SVR730884R1300		0.142 (0.313)
	CM-MPS.31P	1SVR740884R1300		0.133 (0.293)
	CM-MPS.41S	1SVR730884R3300		0.140 (0.309)
	CM-MPS.41P	1SVR740884R3300		0.132 (0.291)
	CM-MPS.23S	1SVR730885R4300		0.149 (0.328)
	CM-MPS.23P	1SVR740885R4300		0.138 (0.304)
	CM-MPS.43S	1SVR730884R4300		0.148 (0.327)
	CM-MPS.43P	1SVR740884R4300		0.137 (0.302)
	CM-MPN.52S	1SVR750487R8300		0.230 (0.507)
	CM-MPN.52P	1SVR760487R8300		0.226 (0.498)
	CM-MPN.62S	1SVR750488R8300		0.229 (0.505)
	CM-MPN.62P	1SVR760488R8300		0.225 (0.496)
	CM-MPN.72S	1SVR750489R8300		0.224 (0.494)
	CM-MPN.72P	1SVR760489R8300		0.220 (0.485)

See "Selection table - Multifunctional" on page 83.

S: screw connection
P: push-in connection



Further documentation three-phase monitoring relays on www.abb.com

Three-phase monitoring relays

Function diagrams

2

Function diagrams - Phase failure detection CM-PBE

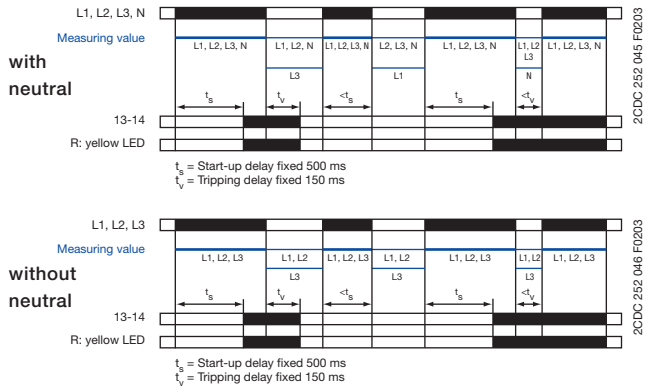

If all phases (and the neutral) are present, the output relay energizes after the start-up delay t_s is complete. If a phase failure occurs, the tripping delay t_v starts. When timing is complete, the output relay de-energizes. As soon as the voltage returns to the tolerance range, timing of t_s starts. When timing is complete, the output relay re-energizes automatically. The yellow LED glows when the output relay is energized.

Function diagrams - Phase failure, under- / overvoltage detection CM-PVE

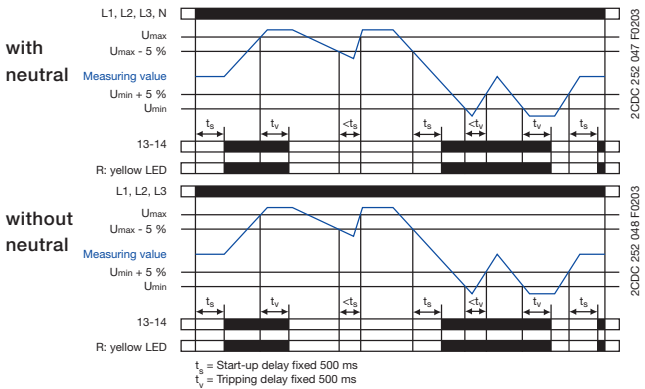

If all phases (and the neutral) are present with correct voltage, the output relay energizes after the start-up delay t_s is complete. If the voltage exceeds or falls below the fixed threshold value or if a phase failure occurs, the tripping delay t_v starts. When timing is complete, the output relay de-energizes. As soon as the voltage returns to the tolerance range, timing of t_s starts. When timing is complete, the output relay re-energizes automatically. The yellow LED glows when the output relay is energized.

Function diagram - Phase failure detection, phase sequence monitoring CM-PFE

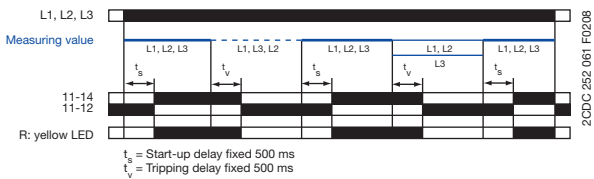

If all phases are present with the correct phase sequence, the output relay energizes after the start-up delay t_s is complete. If a phase failure or a phase sequence error occurs, the tripping delay t_v starts. When timing is complete, the output relay de-energizes. The yellow LED glows when the output relay is energized.

In case of motors which continue running with only two phases, the CM-PFE detects phase failure if the reverse fed voltage is less than 60 % of the originally applied voltage.

Function diagram - Phase failure detection, phase sequence monitoring CM-PFS

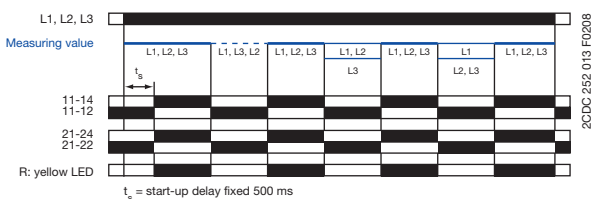

If all phases are present with the correct phase sequence, the output relay energizes after the start-up delay t_s is complete. If a phase failure or a phase sequence error occurs, the output relay de-energizes instantaneous. The yellow LED glows when the output relay is energized.

In case of motors which continue running with only two phases, the CM-PFS detects phase failure if the reverse fed voltage is less than 60 % of the originally applied voltage.

ATTENTION

If several CM-PFS units are placed side by side and the control supply voltage is higher than 415 V, spacing of at least 10 mm has to be kept between the individual units.

Three-phase monitoring relays

Function diagrams

CM-PSS.xx, CM-PVS.xx, CM-PAS.xx, CM-MPS.xx, CM-MPN.xx

Phase sequence monitoring and phase failure detection

Applying control supply voltage begins the fixed start-up delay t_s . When t_s is complete and all phases are present with correct voltage, the output relays energize and the yellow LED R/T glows.

Phase sequence monitoring

If phase sequence monitoring is activated, the output relays de-energize as soon as a phase sequence error occurs. The fault is displayed by alternated flashing of the LEDs F1 and F2. The output relays re-energize automatically as soon as the phase sequence is correct again.

Phase failure detection

The output relays de-energize instantaneous if a phase failure occurs. The fault is indicated by lighting of LED F1 and flashing of LED F2. The output relays re-energize automatically as soon as the voltage returns to the tolerance range.

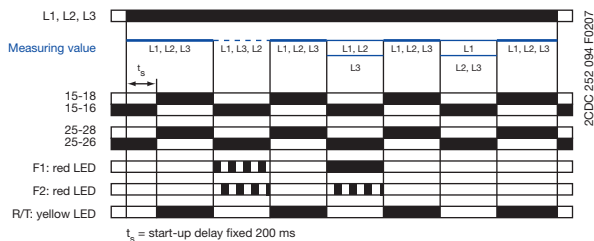

CM-MPS.11, CM-MPS.21, CM-MPS.23

Interrupted neutral monitoring

The interruption of the neutral in the main to be monitored is detected by means of phase unbalance evaluation. Determined by the system, in case of unloaded neutral, i.e. symmetrical load between all three phases, it may happen that an interruption of the neutral will not be detected. If the star point is displaced by asymmetrical load in the three-phase main, an interrupted neutral will be detected.

Displacement of the star point

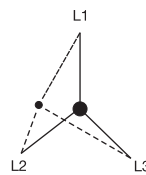

CM-MPS.x3, CM-MPN.x2

Automatic phase sequence correction

This function can be selected only if phase sequence monitoring is activated and operating mode 2x1 c/o (SPDT) contact is selected.

Applying control supply voltage begins the fixed start-up delay t_{S1} . When t_{S1} is complete and all phases are present with correct voltage, output relay R1 energizes. Output relay R2 energizes when the fixed start-up delay t_{S2} is complete and all phases are present with correct phase sequence. Output relay R2 remains de-energized if the phase sequence is incorrect. If the voltage to be monitored exceeds or falls below the set threshold values for phase unbalance, over- or undervoltage or if a phase failure occurs, output relay R1 de-energizes and the LEDs F1 and F2 indicate the fault.

Output relay R2 is responsive only to a false phase sequence. In conjunction with a reversing contactor combination, this enables an automatic correction of the rotation direction. See circuit diagrams on the right.

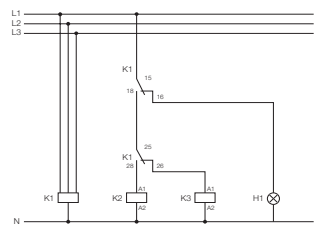
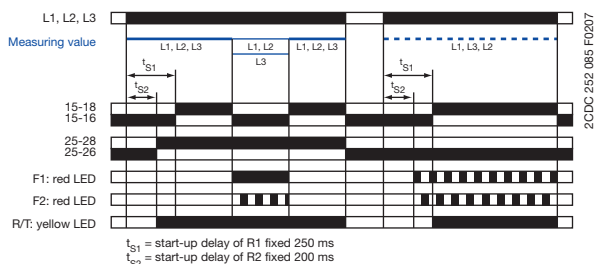

Control circuit diagram
(K1 = CM-MPS.23)

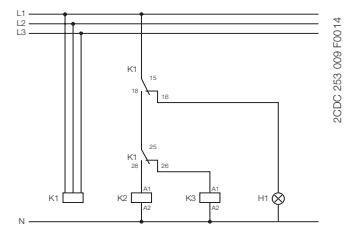

Control circuit diagram
(K1 = CM-MPS.43 or CM-MPN.xx)

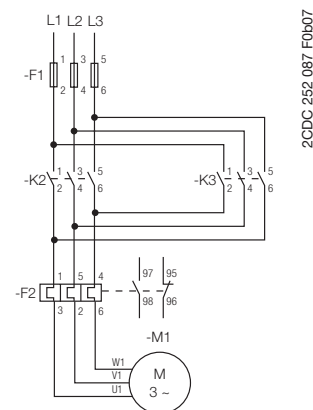

Power circuit diagram

Three-phase monitoring relays

Function diagrams

CM-PSS.xx¹, CM-PVS.xx², CM-MPS.xx², CM-MPN.xx²

Over- and undervoltage monitoring 1x2 c/o

Applying control supply voltage begins the fixed start-up delay t_s . When t_s is complete and all phases are present with correct voltage and with correct phase sequence, the output relays energize and the yellow LED R/T glows.

Type of tripping delay = ON-delay

If the voltage to be monitored exceeds or falls below the fixed¹ or set² threshold value, the output relays de-energize after the set tripping delay t_v is complete. The LED R/T flashes during timing and turns off as soon as the output relays de-energize.

The output relays re-energize automatically as soon as the voltage returns to the tolerance range, taking into account a fixed hysteresis of 5 % and the LED R/T glows.

Type of tripping delay = OFF-delay

If the voltage to be monitored exceeds or falls below the fixed¹ or set² threshold value, the output relays de-energize instantaneously and the LED R/T turns off.

As soon as the voltage returns to the tolerance range, taking into account a fixed hysteresis of 5 %, the output relays re-energize automatically after the set tripping delay t_v is complete. The LED R/T flashes during timing and turns steady when timing is complete.

ON-delay 1x2 c/o contacts 1x2 c/o

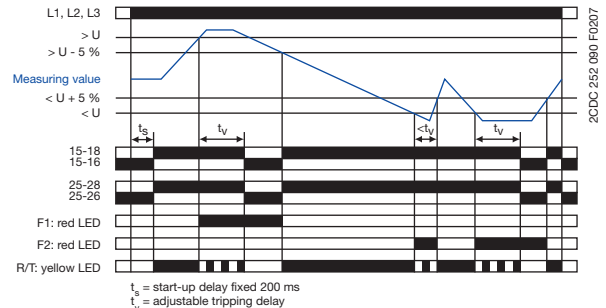

OFF-delay 1x2 c/o contacts 1x2 c/o

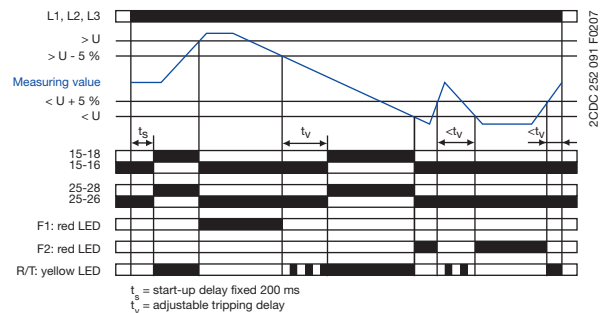

CM-MPS.x3, CM-MPN.x2

Over- and undervoltage monitoring 2x1 c/o

Applying control supply voltage begins the fixed start-up delay t_s . When t_s is complete and all phases are present with correct voltage and with correct phase sequence, the output relays energize. The yellow LED R/T glows as long as at least one output relay is energized.

Type of tripping delay = ON-delay

If the voltage to be monitored exceeds or falls below the set threshold value, output relay R1 (overvoltage) or output relay R2 (undervoltage) de-energizes after the set tripping delay t_v is complete. The LED R/T flashes during timing.

The corresponding output relay re-energizes automatically as soon as the voltage returns to the tolerance range, taking into account a fixed hysteresis of 5 %.

Type of tripping delay = OFF-delay

If the voltage to be monitored exceeds or falls below the set threshold value, output relay R1 (overvoltage) or output relay R2 (undervoltage) de-energizes instantaneously. As soon as the voltage returns to the tolerance range, taking into account a fixed hysteresis of 5 %, the corresponding output relay re-energizes automatically after the set tripping delay t_v is complete. The LED R/T flashes during timing.

ON-delay 2x1 c/o contact 2x1 c/o

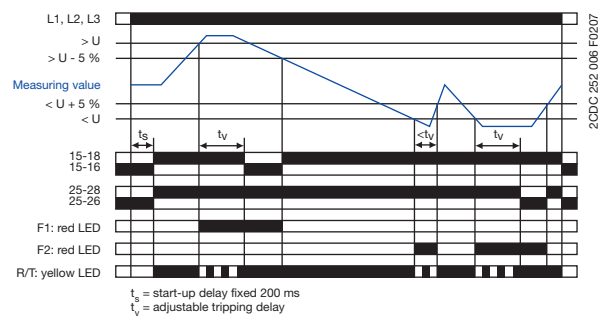

OFF-delay 2x1 c/o contact 2x1 c/o

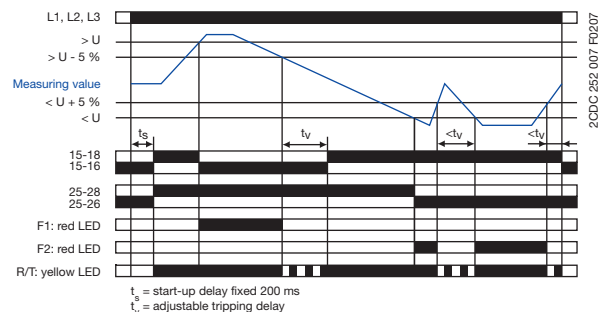

Three-phase monitoring relays

Function diagrams

CM-PAS.xx, CM-MPS.xx, CM-MPN.xx

Phase unbalance monitoring

Applying control supply voltage begins the fixed start-up delay t_s . When t_s is complete and all phases are present with correct voltage and with correct phase sequence, the output relays energize and the yellow LED R/T glows.

Type of tripping delay = ON-delay

If the voltage to be monitored exceeds or falls below the set phase unbalance threshold value, the output relays de-energize after the set tripping delay t_v is complete. The LED R/T flashes during timing and turns off as soon as the output relays de-energize.

The output relays re-energize automatically as soon as the voltage returns to the tolerance range, taking into account a fixed hysteresis of 20 % and the LED R/T glows.

Type of tripping delay = OFF-delay

If the voltage to be monitored exceeds or falls below the set phase unbalance threshold value, the output relays de-energize instantaneously and the LED R/T turns off.

As soon as the voltage returns to the tolerance range, taking into account a fixed hysteresis of 20 %, the output relays re-energize automatically after the set tripping delay t_v is complete. The LED R/T flashes during timing and turns steady when timing is complete.

ON-delay ☒

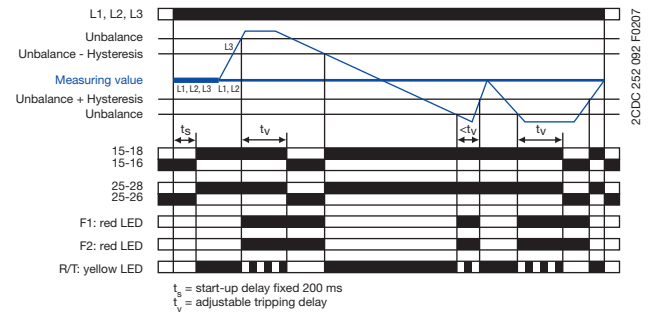

OFF-delay ■

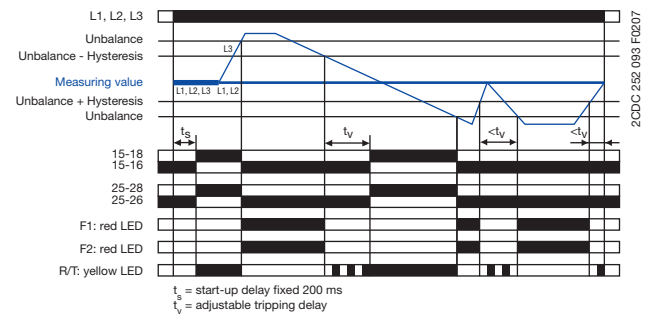

CM-PSS.xx, CM-PSV.xx, CM-PAS.xx, CM-MPS.xx, CM-MPN.xx

LED functions

Function	R/T: yellow LED	F1: red LED	F2: red LED
Control supply voltage applied, output relay energized	High	-	-
Tripping delay t_v active	Flashing	-	-
Phase failure	-	High	High
Phase sequence	-	Alternating	-
Overvoltage	-	High	-
Undervoltage	-	-	High
Phase unbalance	-	High	High
Interruption of the neutral	-	High	High
Adjustment error ¹⁾	Flashing	High	High

1) Possible misadjustments of the front-face operating controls:
Overlapping of the threshold values: An overlapping of the threshold values is given, if the threshold value for overvoltage is set to a smaller value than the threshold value for undervoltage.
DIP switch 3 = OFF and DIP switch 4 = ON: Automatic phase sequence correction is activated and selected operating mode is 1x2 c/o contacts
DIP switch 2 and 4 = ON: Phase sequence detection is deactivated and the automatic phase sequence correction is activated

CM-PSS.xx, CM-PSV.xx, CM-PAS.xx, CM-MPS.xx, CM-MPN.xx

Type of tripping delay

The type of tripping delay ☒ / ■ can be adjusted via a rotary (CM-PxS.xx) or a DIP switch (CM-MPx.xx).

Switch position ON-delay ☒:

In case of a fault, the de-energizing of the output relays and the respective fault message are suppressed for the adjusted tripping delay t_v .

Switch position OFF-delay ■:

In case of a fault, the output relays de-energize instantaneously and a fault message is displayed and stored for the length of the adjusted tripping delay t_v . Thereby, also momentary undervoltage conditions are recognized.

Three-phase monitoring relays

Connection diagrams

2

Connection diagrams CM-PBE, CM-PVE

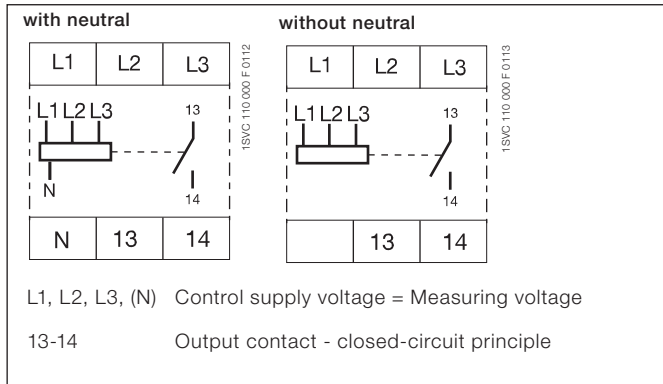

Connection diagram CM-PFE

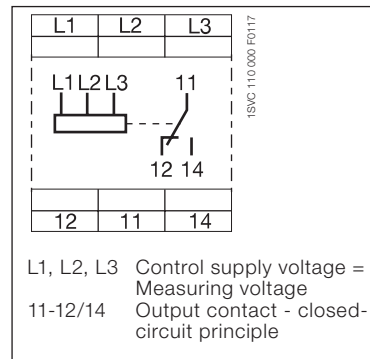

Connection diagram CM-PVS.x1, CM-PSS.x1, CM-PAS.x1

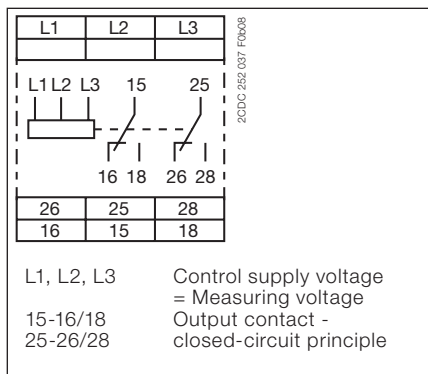

Connection diagram CM-PFS

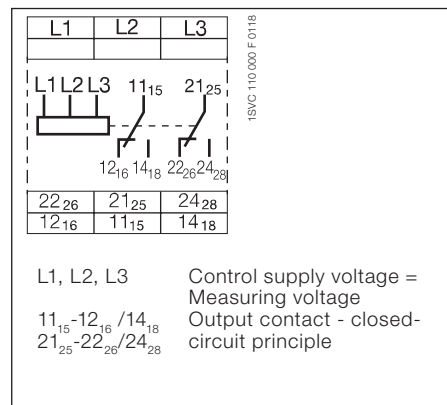

Connection diagram CM-MPS.11, CM-MPS.21, CM-MPS.23

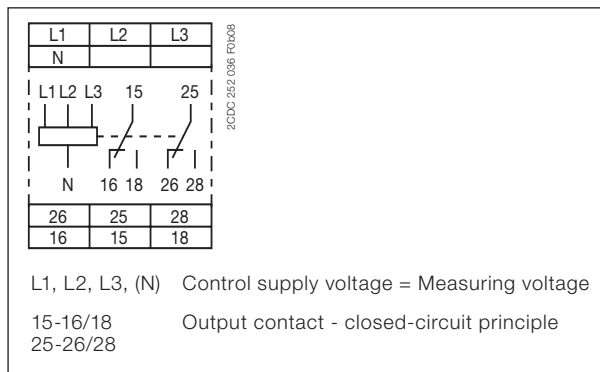

Connection diagram CM-MPS.31, CM-MPS.41, CM-MPS.43

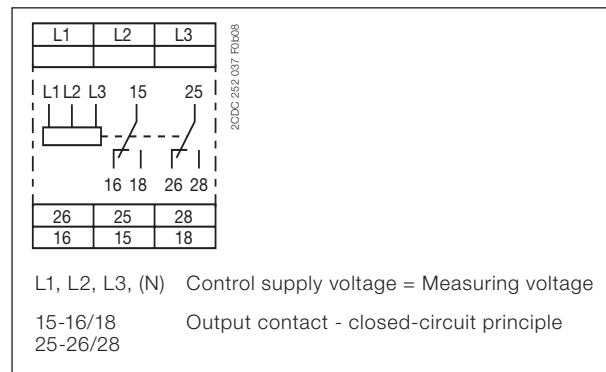

Connection diagram CM-MPN.x2

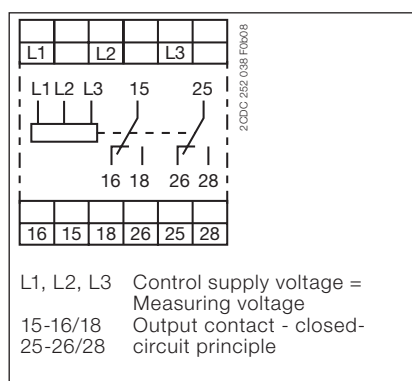

Three-phase monitoring relays DIP switches, Rotary switches

Rotary switch "Function" CM-PVS

	ON-delay with phase sequence monitoring
	OFF-delay with phase sequence monitoring
	ON-delay without phase sequence monitoring
	OFF-delay without phase sequence monitoring

Rotary switch "Function" CM-PSS

	ON-delay with phase sequence monitoring
	OFF-delay with phase sequence monitoring
	ON-delay without phase sequence monitoring
	OFF-delay without phase sequence monitoring

DIP switch functions CM-MPS.x3 and CM-MPN.x2

Position	4	3	2	1
ON ↑				
OFF				

2CDC 232 041 FEN/6

1 Timing function ON ON-delayed OFF OFF-delayed	2 Phase sequence monitoring ON deactivated OFF activated
3 Operating principle of output ON 2x1 c/o contact OFF 1x2 c/o contact	4 Phase sequence correction ON activated OFF deactivated

Output relay R1 is responsive to overvoltage, output relay R2 is responsive to undervoltage. In case of other faults, both output relays react synchronously.

DIP switch functions CM-MPS.x1

Position	2	1
ON ↑		
OFF		

2CDC 232 040 FEN/6

1 Timing function ON ON-delayed OFF OFF-delayed	2 Phase sequence monitoring ON deactivated OFF activated
--	---

Three-phase monitoring relays

Technical data

2

Type	CM-PBE ¹⁾	CM-PBE	CM-PVE ¹⁾	CM-PVE	CM-PFE	CM-PFS	
Supply circuit = measuring circuit	L1-L2-L3-N	L1-L2-L3	L1-L2-L3-N	L1-L2-L3	L1-L2-L3		
Rated control supply voltage U_s = measuring voltage	3x380-440 V AC, 220-240 V AC	3x380-440 V AC	3x320-460 V AC, 185-265 V AC	3x320-460 V AC	3x208-440 V AC	3x200-500 V AC	
Power consumption						approx. 15 VA	
Rated control supply voltage U_s tolerance	-15...+15 %		-15...+10 %		-10...+10 %	-15...+10 %	
Rated frequency	50/60 Hz		50/60 Hz (-10...+10 %)			50/60 Hz	
Duty time	100 %						
Measuring circuit	L1-L2-L3-N	L1-L2-L3	L1-L2-L3-N	L1-L2-L3	L1-L2-L3		
Monitoring functions	phase failure	■	■	■	■	■	
	phase sequence	-	-	-	■	■	
	over- / undervoltage	-	■	■	-	-	
	neutral	■	■	-	-	-	
Measuring ranges	3x380-440 V AC, 220-240 V AC	3x380-440 V AC	3x320-460 V AC, 185-265 V AC	3x320-460 V AC	3x208-440 V AC	3x200-500 V AC	
Thresholds	U_{min}	0.6 x U_N		fixed 185 V / 320 V	fixed 320 V	0.6 x U_N	
	U_{max}			fixed 265 V / 460 V	fixed 460 V		
Hysteresis related to the threshold value	fixed 5 % (release value = 0.65 x U_N)		fixed 5 %		-		
Measuring voltage frequency	50/60 Hz (-10 %...+10 %)				50/60 Hz		
Response time	40 ms		80 ms		500 ms		
Accuracy within the rated control supply voltage tolerance	-				$\Delta U \leq 0.5 \%$		
Accuracy within the temperature range	-				$\Delta U \leq 0.06 \%$ / °C		
Timing circuit							
Start-up delay t_s	fixed 500 ms ($\pm 20 \%$)				fixed 500 ms		
Tripping t_v	fixed 150 ms ($\pm 20 \%$)		at over- / undervoltage fixed 500 ms ($\pm 20 \%$)		fixed 500 ms	-	
Indication of operational states							
Relay status	R: yellow LED	Output relay energized					
Fault message	F: red LED	Only CM-PFS: Phase failure / Phase sequence error					
Output circuits	13-14			11-12/14		11 ₁₅ -12 ₁₆ / 14 ₁₈ [*] 21 ₂₅ -22 ₂₆ / 24 ₂₈	
Kind of output	1 n/o contact				1 c/o contact	2 c/o contacts	
Operating principle	closed-circuit principle ²⁾						
Contact material	AgCdO					AgNi allow, Cd free	
Rated operational voltage U_e	IEC/EN 60947-1		250 V		250 V AC		
Minimum switching voltage / Minimum switching current	- / -						
Maximum switching voltage	250 V AC, 250 V DC						
Rated operational current I_e (IEC/EN 60947-5-1)	AC-12 (resistive) 230 V	4 A					
	AC-15 (inductive) 230 V	3 A					
	DC-12 (resistive) 24 V	4 A					
	DC-13 (inductive) 24 V	2 A					
Mechanical lifetime	30 x 10 ⁶ switching cycles						
Electrical lifetime (AC-12, 230 V, 4 A)	0.1 x 10 ⁶ switching cycles						
Max. fuse rating to achieve short-circuit protection	n/c contact	10 A fast-acting				6 A fast-acting	
	n/o contact	10 A fast-acting					
AC rating (UL 508)	Utilization category (Control Circuit Rating Code)	B 300, CM-PFS: B300, pilot duty general purpose (250 V, 4 A, cos phi 0.75)					
	max. rated operational voltage	300 V AC					
	max. continuous thermal current at B 300	5 A					
	max. making/breaking apparent power at B 300	3600/360 VA					

¹⁾ Device with neutral monitoring: The external conductor voltage towards the neutral conductor is measured.

²⁾ Closed-circuit principle: Output relay is de-energized if the measured value exceeds/drops below the adjusted threshold.

Three-phase monitoring relays

Technical data

Type	CM-PBE ¹⁾	CM-PBE	CM-PVE ¹⁾	CM-PVE	CM-PFE	CM-PFS
General data						
Dimensions (W x H x D)	22.5 x 78 x 78.5 mm (0.89 x 3.07 x 3.09 in) CM-PFS: 22.5 x 78 x 100 mm (0.89 x 3.07 x 3.94 in)					
Weight	see data sheet					
Mounting	DIN rail (IEC/EN 60715)					
Mounting position	any					
Degree of protection	housing / terminals	IP50 / IP20				
Electrical connection						
Wire size	fine-strand with wire end ferrule	2 x 0.75-1.5 mm ² (2 x 18-16 AWG)				Same as CM-PSS.31, see page 2/44.
	fine-strand without wire end ferrule	2 x 1-1.5 mm ² (2 x 18-16 AWG)				
	rigid	2 x 0.75-1.5 mm ² (2 x 18-16 AWG)				
Stripping length	10 mm (0.39 in)				Same as CM-PSS.31, see page 2/44.	
Tightening torque	0.6-0.8 Nm					
Environmental data						
Ambient temperature range	operation / storage	-20...+60 °C / -40...+85 °C				
Environmental testing (IEC 68-2-30)	24 h cycle time, 55 °C, 93 % rel., 96 h					-
Operational reliability (IEC 68-2-6)	6 g					-
Mechanical resistance (IEC 68-2-6)	10 g					-
Climatic category	IEC/EN 60721-3-3	-				3K3
Damp heat, cyclic	IEC/EN 60068-2-30	CM-PFS: 6 x 24 h cycle, 55 °C, 95 % RH				
Vibration, sinusoidal	IEC/EN 60255-21-1	-				Class 2
Shock	IEC/EN 60255-21-2	-				Class 2
Isolation data						
Rated insulation voltage U _i (IEC/EN 60947-1, IEC/EN 60664-1)	between supply, measuring and output circuits	400 V				-
	supply circuit / output circuit	-				600 V
	output circuit 1 / output circuit 2	-				300 V
Rated impulse withstand voltage U _{imp} between all isolated circuits (VDE 0110, IEC 664)	supply circuit / output circuit	4 kV / 1.2 - 50 μs				-
	output circuit 1 / output circuit 2	-				6 kV
	supply circuit / output circuit	-				4 kV
Basic insulation for rated control supply voltage (IEC/EN 60664-1)	supply circuit / output circuit	-				600 V AC
Protective separation (IEC/EN 61140, EN 50178)	supply circuit / output circuit	-				n/a
Test voltage (routine test)	supply circuit / output circuit	2.5 kV, 50 Hz, 1 min.				-
	output circuit 1 / output circuit 2	-				2.5 kV, 50 Hz, 1 min.
	supply circuit / output circuit	-				2.5 kV, 50 Hz, 1 min.
Pollution degree (IEC/EN 60664-1)	3					
Overvoltage category (IEC/EN 60664-1)	III					
Standards						
Product standard	IEC 255-6, EN 60255-6, CM-PFS: IEC/EN 60255-1, IEC/EN 60255-27, EN 50178					
Low Voltage Directive	2006/95/EC					
EMC Directive	2004/108/EC					
RoHS Directive	CM-PFS: 2011/65/EC					
Electromagnetic compatibility						
Interference immunity to	EN 61000-6-2, CM-PFS: EN 61000-6-1, EN 61000-6-2					
electrostatic discharge	IEC/EN 61000-4-2	Level 3 - 6 kV / 8 kV				
radiated, radio-frequency, electromagnetic field	IEC/EN 61000-4-3	Level 3 - 10 V/m (1 GHz) / 3 V/m (2 GHz) / 1 V/m (2.7 GHz)				
electrical fast transient / burst	IEC/EN 61000-4-4	Level 3 - 2 kV / 5 kHz				
surge	IEC/EN 61000-4-5	Level 4 - 2 kV-L				
conducted disturbances, induced by radio-frequency fields	IEC/EN 61000-4-6	Level 3 - 10 V				
voltage dips, short interruptions and voltage variations	IEC/EN 61000-4-11	-				Class 3
harmonics and interharmonics	IEC/EN 61000-4-13	-				Class 3
Interference emission	EN 61000-6-4, CM-PFS: EN 61000-6-3, EN 61000-6-4					
high-frequency radiated	IEC/CISPR 22, EN 55022	-				Class B
high-frequency conducted	IEC/CISPR 22, EN 55022	-				Class B

¹⁾ Device with neutral monitoring: The external conductor voltage towards the neutral conductor is measured.

Three-phase monitoring relays

Technical data

2

Type	CM-PSS.31	CM-PSS.41	CM-PVS.31	CM-PVS.41	CM-PVS.81	CM-PAS.31	CM-PAS.41	
Input circuit = Measuring circuit	L1, L2, L3							
Rated control supply voltage U_s = measuring voltage	3x380 V AC	3x400 V AC	3x160-300 V AC	3x300-500 V AC	3x200-400 V AC	3x160-300 V AC	3x300-500 V AC	
Rated control supply voltage U_s tolerance	-15...+10 %							
Rated frequency	50/60 Hz							
Frequency range	45-65 Hz							
Typical current / power consumption	25 mA / 18 VA (380 V AC)	25 mA / 18 VA (400 V AC)	25 mA / 10 VA (230 V AC)	25 mA / 18 VA (400 V AC)	19 mA / 10 VA (300 V AC)	25 mA / 10 VA (230 V AC)	25 mA / 18 VA (400 V AC)	
Measuring circuit	L1, L2, L3							
Monitoring functions	Phase failure	■	■	■	■	■	■	
	Phase sequence	can be switched off					■	■
	Automatic phase sequence correction	-	-	-	-	-	-	
	Over- / undervoltage	■	■	■	■	■	-	
	Phase unbalance	-	-	-	-	■	■	
	Neutral	-	-	-	-	-	-	
Measuring range	Overvoltage	3x418 V AC	3x440 V AC	3x220-300 V AC	3x420-500 V AC	3x300-400 V AC	-	
	Undervoltage	3x342 V AC	3x360 V AC	3x160-230 V AC	3x300-380 V AC	3x210-300 V AC	-	
	Phase unbalance	-	-	-	-	-	2-25 % of average of phase voltages	
Thresholds	Overvoltage	fixed	-	adjustable within measuring range		-	-	
	Undervoltage	fixed	-	adjustable within measuring range		-	-	
	Phase unbalance (switch-off value)	-	-	-	-	-	adjust. within meas. range	
Hysteresis related to the threshold value	Over- / undervoltage	fixed 5 %	-	-	-	-	-	
	Phase unbalance	-	-	-	-	-	fixed 20 %	
Rated frequency of the measuring signal	50/60 Hz							
Frequency range of the measuring signal	45-65 Hz							
Maximum measuring cycle time	100 ms							
Accuracy within the rated control supply voltage tolerance	$\Delta U \leq 0.5 \%$							
Accuracy within the temperature range	$\Delta t \leq 0.06 \%$ / °C							
Measuring method	True RMS							
Timing circuit								
Start-up delay t_s	fixed 200 ms							
Tripping delay t_v	ON- or OFF-delay 0; 0.1-30 s adjustable					ON- delay 0; 0.1-30 s adjustable		
Repeat accuracy (constant parameters)	-				< $\pm 0.2 \%$		-	
Accuracy within the rated control supply voltage tolerance	$\Delta t \leq 0.5 \%$							
Accuracy within the temperature range	$\Delta t \leq 0.06 \%$ / °C							
Indication of operational states	Details see function description / -diagrams		1 yellow LED, 2 red LED's			Details see function description / -diagrams		
Output circuits	15-16/18, 25-26/28							
Kind of output	relay, 2 x 1 c/o contact							
Operating principle	closed-circuit principle ¹⁾							
Contact material	AgNi alloy, Cd free							
Rated operational voltage U_o	IEC/EN 60947-1	250 V						
Minimum switching power	24 V / 10 mA							
Maximum switching voltage	see "Load limit curves" on page 173							

¹⁾ Closed-circuit principle: Output relay(s) de-energize(s) if measured value exceeds or falls below the adjusted threshold value

Three-phase monitoring relays

Technical data

Type	CM-PSS.31	CM-PSS.41	CM-PVS.31	CM-PVS.41	CM-PVS.81	CM-PAS.31	CM-PAS.41
Rated operational current I _o (IEC/EN 60947-5-1)	AC-12 (resistive) 230 V	4 A					
	AC-15 (inductive) 230 V	3 A					
	DC-12 (resistive) 24 V	4 A					
	DC-13 (inductive) 24 V	2 A					
AC rating (UL 508)	Utilization category (Control Circuit Rating Code)	B 300					
	max. rated operational voltage	300 V AC					
	max. continuous thermal current at B 300	5 A					
	max. making/breaking apparent power at B 300	3600/360 VA					
Mechanical lifetime		30 x 10 ⁶ switching cycles					
Electrical lifetime (AC-12, 230 V, 4 A)		0.1 x 10 ⁶ switching cycles					
Max. fuse rating to achieve short-circuit protection	n/c contact	6 A fast-acting					
	n/o contact	10 A fast-acting					
General data							
MTBF		on request					
Duty time		100%					
Dimensions (W x H x D)	product dimensions	22.5 x 85.6 x 103.7 mm (0.89 x 3.37 x 4.08 in)					
	packaging dimensions	97 x 109 x 30 mm (3.82 x 4.29 x 1.18 in)					
Weight		depending on device, see ordering details					
Mounting		DIN rail (IEC/EN 60715), snap-on mounting without any tool					
Mounting position		any					
Minimum distance to other units	horizontal	10 mm (0.39 in) in case of continuous measuring voltages					
		> 400 V	> 400 V	> 220 V	> 400 V	-	> 220 V
Material of housing		UL 94 V-0					
Degree of protection	housing / terminals	IP50 / IP20					
Electrical connection							
Wire size		Screw connection technology			Easy Connect Technology (Push-in)		
fine-strand with(out) wire end ferrule		1 x 0.5-2.5 mm ² (1 x 20-14 AWG)			2 x 0.5-1.5 mm ² (2 x 20-16 AWG)		
		2 x 0.5-1.5 mm ² (2 x 20-16 AWG)					
	rigid	1 x 0.5-4 mm ² (1 x 20-12 AWG)			2 x 0.5-1.5 mm ² (2 x 20-16 AWG)		
		2 x 0.5-2.5 mm ² (2 x 20-14 AWG)					
Stripping length		8 mm (0.32 in)					
Tightening torque		0.6-0.8 Nm (5.31-7.08 lb.in)					
Environmental data							
Ambient temperature ranges	operation / storage	-25...+60 °C / -40...+85 °C					
Damp heat (IEC 60068-2-30)		55 °C, 6 cycles					
Climatic category		3K3					
Vibration (sinusoidal) (IEC/EN 60255-21-1)		Class 2					
Shock (IEC/EN 60255-21-2)		Class 2					
Isolation data							
Rated insulation voltage U _i	input circuit / output circuit	600 V					
	output circuit 1 / output circuit 2	300 V					
Rated impulse withstand voltage U _{imp} (VDE 0110, IEC/EN 60664)	input circuit	6 kV; 1.2/50 μs					
	output circuit	4 kV; 1.2/50 μs					
Test voltage between all isolated circuits (routine test)		2.5 kV, 50 Hz, 1 s					
Basic insulation	input circuit / output circuit	600 V					
Protective separation (VDE 0106 part 101 and 101/A, IEC/EN 1140)	input circuit / output circuit	-					
Pollution degree (VDE 0110, IEC/EN 60664)		3					
Overvoltage category (VDE 0110, IEC 60664)		III					
Standards							
Product standard		IEC/EN 60255-6, EN 50178					
Low Voltage Directive		2006/95/EC					
EMC directive		2004/108/EC					
RoHS directive		2011/65/EC					
Electromagnetic compatibility							
Interference immunity to		EN 61000-6-1, EN 61000-6-2					
electrostatic discharge	IEC/EN 61000-4-2	Level 3 (6 kV / 8 kV)					
radiated, radio-frequency, electromagnetic field	IEC/EN 61000-4-3	Level 3 (10 V/m)					
electrical fast transient / burst	IEC/EN 61000-4-4	Level 3 (2 kV / 2 kHz)					
surge	IEC/EN 61000-4-5	Level 4 (2 kV L-L)					
conducted disturbances, induced by radio- frequency fields	IEC/EN 61000-4-6	Level 3 (10 V)					
Interference emission		EN 61000-6-3, EN 61000-6-4					
high-frequency radiated	IEC/CISPR 22, EN 55022	Class B					
high-frequency conducted	IEC/CISPR 22, EN 55022	Class B					

Three-phase monitoring relays

Technical data

2

Type	CM-MPS.11	CM-MPS.21	CM-MPS.31	CM-MPS.41
Input circuit = Measuring circuit	L1, L2, L3, N		L1, L2, L3	
Rated control supply voltage U_s = measuring voltage	3x90-170 V AC	3x180-280 V AC	3x160-300 V AC	3x300-500 V AC
Rated control supply voltage U_s tolerance	-15...+10 %			
Rated frequency	50/60 Hz			
Frequency range	45-65 Hz			
Typical current / power consumption	25 mA / 10 VA (115 V AC)	25 mA / 18 VA (230 V AC)	25 mA / 10 VA (230 V AC)	25 mA / 18 VA (400 V AC)
Measuring circuit	L1, L2, L3, N		L1, L2, L3	
Monitoring functions	Phase failure	■	■	■
	Phase sequence	can be switched off		
	Automatic phase sequence correction	-	-	-
	Over- / undervoltage	■	■	■
	Phase unbalance	■	■	■
	Interrupted neutral	■	■	-
Measuring range	Overvoltage	3x120-170 V AC	3x240-280 V AC	3x220-300 V AC
	Undervoltage	3x90-130 V AC	3x180-220 V AC	3x160-230 V AC
	Phase unbalance	2-25 % of average of phase voltages		
Thresholds	Overvoltage	adjustable within measuring range		
	Undervoltage	adjustable within measuring range		
	Phase unbalance (switch-off value)	adjustable within measuring range		
Hysteresis related to the threshold value	Over- / undervoltage	fixed 5 %		
	Phase unbalance	fixed 20 %		
Rated frequency of the measuring signal	50/60 Hz			
Frequency range of the measuring signal	45-65 Hz			
Maximum measuring cycle time	100 ms			
Accuracy within the rated control supply voltage tolerance	$\Delta U \leq 0.5 \%$			
Accuracy within the temperature range	$\Delta U \leq 0.06 \% / ^\circ\text{C}$			
Measuring method	True RMS			
Timing circuit				
Start-up delay t_s	fixed 200 ms			
Tripping delay t_T	ON- or OFF-delay 0; 0.1-30 s adjustable			
Accuracy within the rated control supply voltage tolerance	$\Delta t \leq 0.5 \%$			
Accuracy within the temperature range	$\Delta t \leq 0.06 \% / ^\circ\text{C}$			
Indication of operational states	Details see function description / -diagrams			
Output circuits	15-16/18, 25-26/28			
Kind of output	relay, 1 x 2 c/o contacts			
Operating principle	closed-circuit principle ¹⁾			
Contact material	AgNi alloy, Cd free			
Rated operational voltage U_o (IEC/EN 60947-1)	250 V			
Minimum switching power	24 V / 10 mA			
Maximum switching voltage	see "Load limit curves" on page 173			
Rated operational current I_o (IEC/EN 60947-5-1)	AC-12 (resistive) 230 V	4 A		
	AC-15 (inductive) 230 V	3 A		
	DC-12 (resistive) 24 V	4 A		
	DC-13 (inductive) 24 V	2 A		
AC rating (UL 508)	Utilization category (Control Circuit Rating Code)	B 300		
	max. rated operational voltage	300 V AC		
	max. continuous thermal current at B 300	5 A		
	max. making/breaking apparent power at B 300	3600/360 VA		
Mechanical lifetime	30 x 10 ⁶ switching cycles			
Electrical lifetime (AC-12, 230 V, 4 A)	0.1 x 10 ⁶ switching cycles			
Max. fuse rating to achieve short-circuit protection	n/c contact	6 A fast-acting		
	n/o contact	10 A fast-acting		

¹⁾ Closed-circuit principle: Output relay(s) de-energize(s) if measured value exceeds or falls below the adjusted threshold value

Three-phase monitoring relays

Technical data

Type		CM-MPS.11	CM-MPS.21	CM-MPS.31	CM-MPS.41
General data					
MTBF		on request			
Duty time		100%			
Dimensions (W x H x D)	product dimensions	22.5 x 85.6 x 103.7 mm (0.89 x 3.37 x 4.08 in)			
	packaging dimensions	97 x 109 x 30 mm (3.82 x 4.29 x 1.18 in)			
Weight		Screw connection technology		Easy Connect Technology (Push-in)	
	net weight	depending on device, see ordering details			
	gross weight	depending on device, see ordering details			
Mounting		DIN rail (IEC/EN 60715), snap-on mounting without any tool			
Mounting position		any			
Minimum distance to other units	horizontal	10 mm (0.39 in) in case of continuous measuring voltages > 120 V		> 240 V	> 220 V
					> 400 V
Material of housing		UL 94 V-0			
Degree of protection	housing / terminals	IP50 / IP20			
Electrical connection					
Wire size		Screw connection technology		Easy Connect Technology (Push-in)	
	fine-strand with(out) wire end ferrule	1 x 0.5-2.5 mm ² (1 x 20-14 AWG)		2 x 0.5-1.5 mm ² (2 x 20-16 AWG)	
		2 x 0.5-1.5 mm ² (2 x 20-16 AWG)			
rigid	1 x 0.5-4 mm ² (1 x 20-12 AWG)		2 x 0.5-1.5 mm ² (2 x 20-16 AWG)		
	2 x 0.5-2.5 mm ² (2 x 20-14 AWG)				
Stripping length		8 mm (0.32 in)			
Tightening torque		0.6-0.8 Nm (5.31-7.08 lb.in)		-	
Environmental data					
Ambient temperature ranges	operation / storage	-25...+60 °C / -40...+85 °C			
Damp heat (IEC 60068-2-30)		55 °C, 6 cycles			
Climatic category		3K3			
Vibration (sinusoidal) (IEC/EN 60255-21-1)		Class 2			
Shock (IEC/EN 60255-21-2)		Class 2			
Isolation data					
Rated insulation voltage U _i	input circuit / output circuit	600 V			
	output circuit 1 / output circuit 2	300 V			
Rated impulse withstand voltage U _{imp} (VDE 0110, IEC/EN 60664)	input circuit	6 kV; 1.2/50 μs			
	output circuit	4 kV; 1.2/50 μs			
Test voltage between all isolated circuits (routine test)		2.5 kV, 50 Hz, 1 s			
Basic insulation	input circuit / output circuit	600 V			
Protective separation (VDE 0106 part 101 and 101/A, IEC/EN 61140)	input circuit / output circuit	yes		-	
Pollution degree (VDE 0110, IEC/EN 60664)		3			
Overvoltage category (VDE 0110, IEC 60664)		III			
Standards					
Product standard		IEC/EN 60255-1, EN 50178			
Low Voltage Directive		2006/95/EC			
EMC directive		2004/108/EC			
RoHS directive		2011/65/EC			
Electromagnetic compatibility					
Interference immunity to electrostatic discharge		EN 61000-6-1, EN 61000-6-2			
	IEC/EN 61000-4-2	Level 3 (6 kV / 8 kV)			
radiated, radio-frequency, electromagnetic field	IEC/EN 61000-4-3	Level 3 (10 V/m)			
electrical fast transient / burst surge	IEC/EN 61000-4-4	Level 3 (2 kV / 2 kHz)			
	IEC/EN 61000-4-5	Level 4 (2 kV L-N)		Level 4 (2 kV L-L)	
conducted disturbances, induced by radio-frequency fields	IEC/EN 61000-4-6	Level 3 (10 V)			
harmonics and interharmonics	IEC/EN 61000-4-13	Class 3			
Interference emission		EN 61000-6-3, EN 61000-6-4			
high-frequency radiated	IEC/CISPR 22, EN 55022	Class B			
high-frequency conducted	IEC/CISPR 22, EN 55022	Class B			

Three-phase monitoring relays

Technical data

2

Type	CM-MPS.23	CM-MPS.43	CM-MPN.52	CM-MPN.62	CM-MPN.72
Input circuit = Measuring circuit	L1, L2, L3, N		L1, L2, L3		
Rated control supply voltage U_s = measuring voltage	3x180-280 V AC	3x300-500 V AC	3x350-580 V AC	3x450-720 V AC	3x530-820 V AC
Rated control supply voltage U_s tolerance	-15...+10 %				
Rated frequency	50/60/400 Hz		50/60 Hz		
Frequency range	45-440 Hz		45-65 Hz		
Typical current / power consumption	5 mA / 4 VA (230 V AC)	5 mA / 4 VA (400 V AC)	29 mA / 41 VA (480 V AC)	29 mA / 52 VA (600 V AC)	29 mA / 59 VA (690 V AC)
Measuring circuit	L1, L2, L3, N		L1, L2, L3		
Monitoring functions	Phase failure	■	■	■	■
	Phase sequence	can be switched off			
	Automatic phase sequence correction	configurable			
	Over- / undervoltage	■	■	■	■
	Phase unbalance	■	■	■	■
	Interrupted neutral	■	-	-	-
Measuring range	Overvoltage	3x240-280 V AC	3x420-500 V AC	3x480-580 V AC	3x600-720 V AC
	Undervoltage	3x180-220 V AC	3x300-380 V AC	3x350-460 V AC	3x450-570 V AC
	Phase unbalance	2-25 % of average of phase voltages			
Thresholds	Overvoltage	adjustable within measuring range			
	Undervoltage	adjustable within measuring range			
	Phase unbalance (switch-off value)	adjustable within measuring range			
Hysteresis related to the threshold value	Over- / undervoltage	fixed 5 %			
	Phase unbalance	fixed 20 %			
Rated frequency of the measuring signal	50/60/400 Hz		50/60 Hz		
Frequency range of the measuring signal	45-440 Hz		45-65 Hz		
Maximum measuring cycle time	100 ms				
Accuracy within the rated control supply voltage tolerance	$\Delta U \leq 0.5 \%$				
Accuracy within the temperature range	$\Delta U \leq 0.06 \% / ^\circ\text{C}$				
Measuring method	True RMS				
Timing circuit	15-16/18, 25-26/28				
Start-up delay t_{s2} and t_{s2}	fixed 200 ms				
Start-up delay t_{s1}	fixed 250 ms				
Tripping delay t_v	ON- or OFF-delay 0; 0.1-30 s adjustable				
Accuracy within the rated control supply voltage tolerance	$\Delta t \leq 0.5 \%$				
Accuracy within the temperature range	$\Delta t \leq 0.06 \% / ^\circ\text{C}$				
Indication of operational states	Details see function description / - diagrams				
Output circuits	15-16/18, 25-26/28				
Kind of output	relay, 2 x 1 or 1 x 2 c/o contacts configurable				
Operating principle	closed-circuit principle ¹⁾				
Contact material	AgNi alloy, Cd free				
Rated operational voltage U_e	IEC/EN 60947-1 250 V				
Minimum switching power	24 V / 10 mA				
Maximum switching voltage	see "Load limit curves" on page 173				
Rated operational current I_e (IEC/EN 60947-5-1)	AC-12 (resistive) 230 V	4 A			
	AC-15 (inductive) 230 V	3 A			
	DC-12 (resistive) 24 V	4 A			
	DC-13 (inductive) 24 V	2 A			
AC rating (UL 508)	Utilization category	B 300			
	(Control Circuit Rating Code)				
	max. rated operational voltage	300 V AC			
	max. continuous thermal current at B 300	5 A			
	max. making/breaking apparent power at B 300	3600/360 VA			
Mechanical lifetime	30 x 10 ⁶ switching cycles				
Electrical lifetime (AC-12, 230 V, 4 A)	0,1 x 10 ⁶ switching cycles				
Max. fuse rating to achieve short-circuit protection	n/c contact	6 A fast-acting	10 A fast-acting		
	n/o contact	10 A fast-acting			

¹⁾ Closed-circuit principle: Output relay(s) de-energize(s) if measured value exceeds or falls below the adjusted threshold value

Three-phase monitoring relays

Technical data

Type	CM-MPS.23	CM-MPS.43	CM-MPN.52	CM-MPN.62	CM-MPN.72
General data					
MTBF	on request				
Duty time	100%				
Dimensions (W x H x D)	product dimensions	22.5 x 85.6 x 103.7 mm (0.89 x 3.37 x 4.08 in)			
	packaging dimensions	97 x 109 x 30 mm (3.82 x 4.29 x 1.18 in)			
Weight	depending on device, see ordering details				
Mounting	DIN rail (IEC/EN 60715), snap-on mounting without any tool				
Mounting position	any				
Minimum distance to other units	vertical / horizontal	not necessary / not necessary			
Material of housing	UL 94 V-0				
Degree of protection	housing / terminals	IP50 / IP20			
Electrical connection					
Wire size	fine-strand with(out) wire end ferrule	Screw connection technology		Easy Connect Technology (Push-in)	
		1 x 0.5-2.5 mm ² (1 x 20-14 AWG)		2 x 0.5-1.5 mm ² (2 x 20-16 AWG)	
		2 x 0.5-1.5 mm ² (2 x 20-16 AWG)		2 x 0.5-1.5 mm ² (2 x 20-16 AWG)	
Stripping length	rigid	1 x 0.5-4 mm ² (1 x 20-12 AWG)		2 x 0.5-1.5 mm ² (2 x 20-16 AWG)	
		2 x 0.5-2.5 mm ² (2 x 20-14 AWG)		8 mm (0.32 in)	
Tightening torque	0.6-0.8 Nm (5.31-7.08 lb.in)				-
Environmental data					
Ambient temperature ranges	operation / storage	-25...+60 °C / -40...+85 °C			
Damp heat (IEC 60068-2-30)	55 °C, 6 cycles				
Climatic category	3K3				
Vibration (sinusoidal) (IEC/EN 60255-21-1)	Class 2				
Shock (IEC/EN 60255-21-2)	Class 2				
Isolation data					
Rated insulation voltage U _i	input circuit / output circuit	600 V		1000 V	
	output circuit 1 / 2	300 V			
Rated impulse withstand voltage U _{imp} (VDE 0110, IEC/EN 60664)	input circuit	6 kV; 1.2/50 μs		8 kV; 1.2/50 μs	
	output circuit	4 kV; 1.2/50 μs			
Test voltage (routine test) between	isolated output circuits	2.5 kV, 50 Hz, 1 s			
	input circuit and isolated output circuits	2.5 kV, 50 Hz, 1 s		4 kV, 50 Hz, 1 s	
Basic insulation	input circuit / output circuit	600 V		1000 V	
Protective separation (VDE 0106 part 101 and 101/A, IEC/EN 61140)	input circuit / output circuit	-			
Pollution degree (VDE 0110, IEC/EN 60664)	3				
Overvoltage category (VDE 0110, IEC 60664)	III				
Standards					
Product standard	IEC/EN 60255-1, EN 50178				
Low Voltage Directive	2006/95/EC				
EMC directive	2004/108/EC				
RoHS directive	2011/65/EC				
Electromagnetic compatibility					
Interference immunity to	electrostatic discharge	EN 61000-6-1, EN 61000-6-2			
	radiated, radio-frequency, electromagnetic field	IEC/EN 61000-4-2	Level 3 (6 kV / 8 kV)		
	electrical fast transient / burst	IEC/EN 61000-4-4	Level 3 (2 kV / 2 kHz)		
	surge	IEC/EN 61000-4-5	Level 4 (2 kV L-N)	Level 4 (2 kV L-L)	
	conducted disturbances, induced by radio-frequency fields	IEC/EN 61000-4-6	Level 3 (10 V)		
harmonics and interharmonics	IEC/EN 61000-4-13	Class 3			
Interference emission	high-frequency radiated	EN 61000-6-3, EN 61000-6-4			
	high-frequency conducted	IEC/CISPR 22, EN 55022	Class B		
	high-frequency conducted	IEC/CISPR 22, EN 55022	Class B		

Grid feeding monitoring relays - Voltage and frequency monitoring functions Product group picture

2



Grid feeding monitoring relays - Voltage and frequency monitoring functions Table of contents

Grid feeding monitoring relays - Voltage and frequency monitoring functions

Grid feeding monitoring relays -	
Voltage and frequency monitoring functions	100
Benefits and advantages, operating controls	101
Applications	102
Applications, connection diagram	103
Ordering and selection	104
Technical data - CM-UFD.Mxx	105

Grid feeding monitoring relays - Voltage and frequency monitoring functions

Benefits and advantages, operating controls

2

Characteristics for all CM-UFD devices

- Monitoring of voltage and frequency in single- and three-phase mains 2-wire, 3-wire or 4-wire
- Over- and undervoltage, 10 minutes average value as well as over- and underfrequency monitoring
- Two-level threshold settings for over-/undervoltage and frequency
- Multiline, backlit LCD display
- All threshold values adjustable as absolute values
- True RMS measuring principle
- High measurement accuracy
- 3 control inputs for remote trip, feedback signal, and external signal
- Interrupted neutral detection
- Error memory for up to 99 entries (incl. cause of error, measured value, relative timestamp)
- Test function
- Password setting protection
- 3 c/o (SPDT) contacts
- LEDs for the indication of operational states

Characteristics CM-UFD.M22

- ROCOF (rate of change of frequency) monitoring configurable
- Third party certificate confirming accordance with CEI 0-21
- Pre-setting according to CEI 0-21

Characteristics CM-UFD.M31

- ROCOF (rate of change of frequency) monitoring and vector shift detection configurable
- Third party certificate confirming accordance with VDE-AR-N 4105 and BDEW
- Pre-settings according to VDE-AR-N 4105 and BDEW

Characteristics CM-UFD.M33

- ROCOF (rate of change of frequency) monitoring and vector shift detection configurable
- Factory certificate confirming accordance with Engineering Recommendation G59 Issue 3 - September 2013; Engineering Recommendation G83 Issue 2 - December 2012
- Pre-setting according to G59/3 LV + G83/2 HV
- UL 508, CAN/CSA C22.2 No.14

Characteristics CM-UFD.M34

- ROCOF (rate of change of frequency) monitoring and vector shift detection, configurable
- Pre-setting according to DRRG standard of DEWA

CM-UFD.Mxx

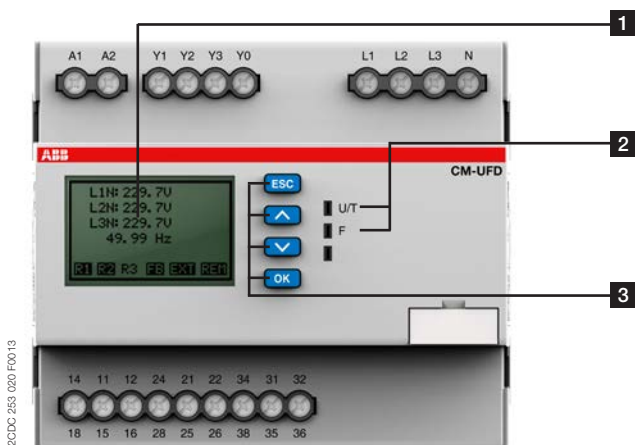

1 Display

R1 R2 R3 - relay status; in this case R3 is de-energized
 FB - status feedback loop Y0-Y1; in this case FB is closed
 EXT - status input external signal; in this case input is closed
 REM - status remote trip input; in this case input is closed

2 Indication of operational states

U/T: green LED - supply voltage applied / flashing = timing active
 F: red LED - failure

3 Keypad

ESC: escape / return to previous menu
 Λ: up / value increase
 ∇: down / value decrease
 OK: enter / confirm selection

Grid feeding monitoring relays - Voltage and frequency monitoring functions Applications

Example of single-phase application CM-UFD.M22

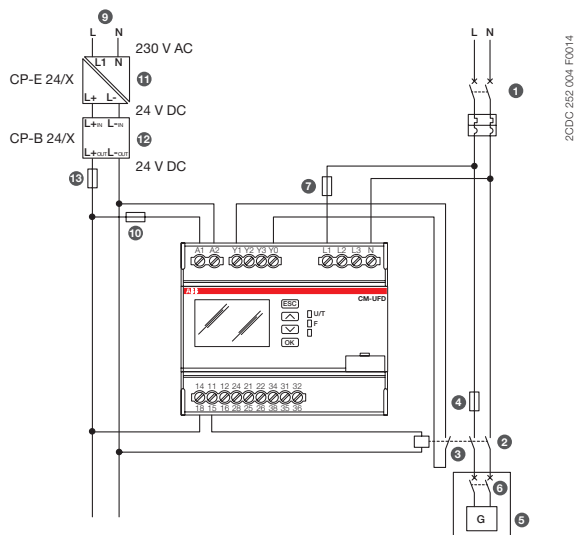

2CDC 252 004 F0014

1. Main circuit breaker DG or DGL
2. DDI: Automatic circuit breaker or contactor equipped with low voltage coil and motor for automatic closure
3. Auxiliary contact of DDI, necessary for realizing the feedback function (compulsory for CM-UFD.M22)
4. DDI short-circuit protection
5. Generator and/or inverter
6. Generator (DDG)
7. Protection fuse for the measuring circuit of the CM-UFD.M22 (optional)
8. Shunt trip coil for feedback function (P>20 kW). This coil can control DG/DGL or DDG devices

Example of three-phase application CM-UFD.M22

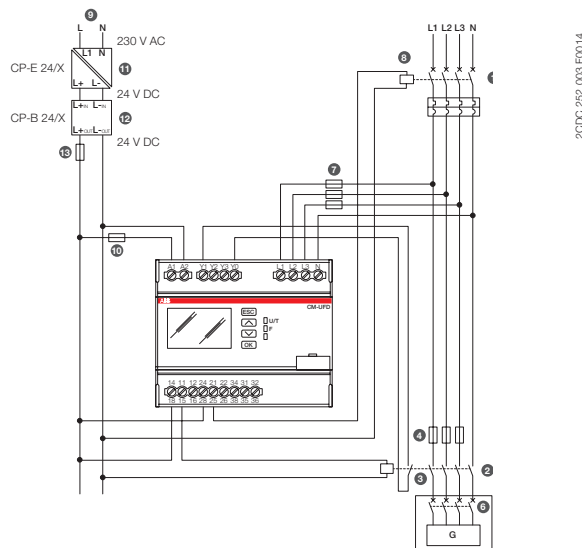

2CDC 252 003 F0014

9. Control supply voltage for CM-UFD.M22 (SPI) and tripping device (DDI)*
10. Device protection fuse for the CM-UFD.M22
11. Primary switch mode power supply unit CP-E (230 V AC / 24 V DC) for the buffer module CP-B*
12. Ultra-capacitor based buffer module CP-B (24 V DC in/out)
13. Wire protection fuse for the output of the buffer module CP-B

* In accordance to CEI 0-21 regulation, in case of loss of control supply voltage it's asked to guarantee, at least for 5 seconds, the functionality of the CM-UFD.M22, the operability of the DDI and when present the command coil for operating the redundancy device. This function has to be realized by external buffer or UPS devices.

Example of single-phase application - CM-UFD.M31

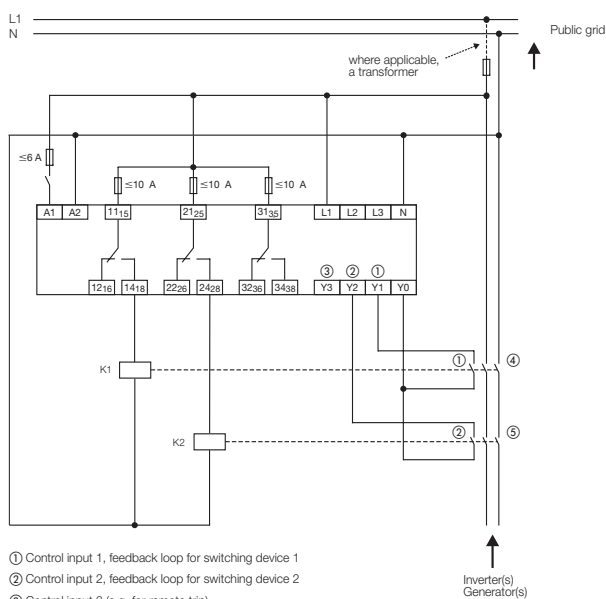

2CDC 252 008 F0213

- ① Control input 1, feedback loop for switching device 1
- ② Control input 2, feedback loop for switching device 2
- ③ Control input 3 (e.g. for remote trip)
- ④ Switching device 1 of the section switch
- ⑤ Switching device 2 of the section switch

Example of three-phase application - CM-UFD.M31

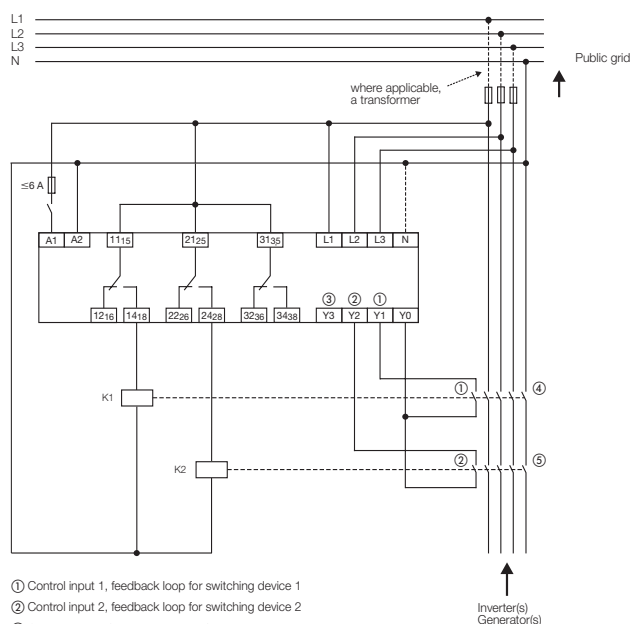

2CDC 252 007 F0213

- ① Control input 1, feedback loop for switching device 1
- ② Control input 2, feedback loop for switching device 2
- ③ Control input 3 (e.g. for remote trip)
- ④ Switching device 1 of the section switch
- ⑤ Switching device 2 of the section switch

Grid feeding monitoring relays - Voltage and frequency monitoring functions Applications, connection diagram

2

Example of single-phase application - CM-UFD.M33

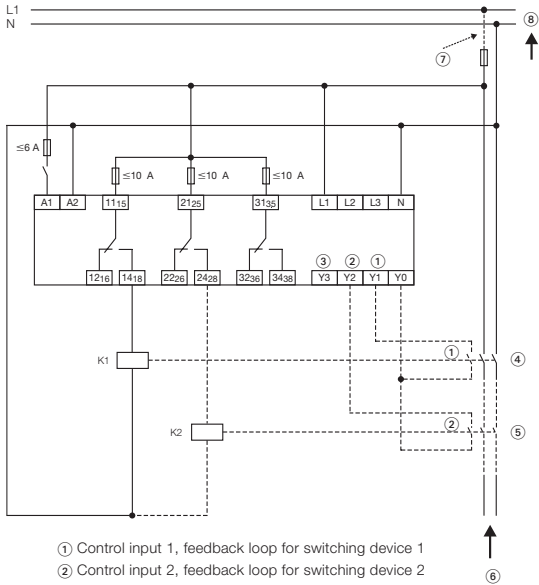

- ① Control input 1, feedback loop for switching device 1
- ② Control input 2, feedback loop for switching device 2
- ③ Control input 3 (e.g. for remote trip)
- ④ Switching device 1 of the section switch
- ⑤ Switching device 2 of the section switch
- ⑥ Inverter(s) / generator(s)
- ⑦ Transformer (if applicable)
- ⑧ Public grid

2CDC 252 005 F0014

Example of three-phase application - CM-UFD.M33

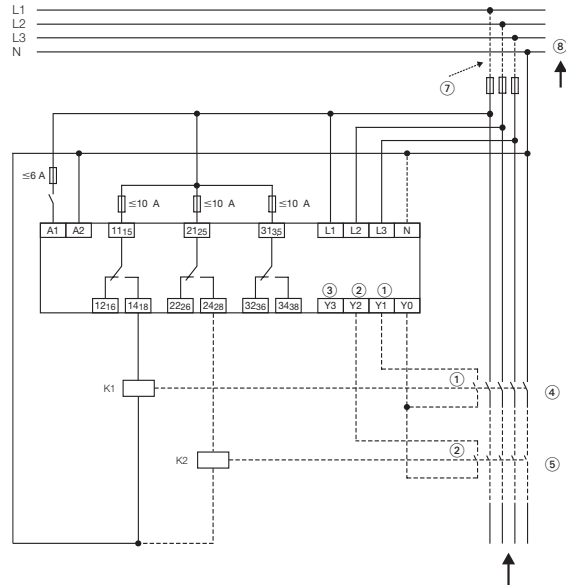

- ① Control input 1, feedback loop for switching device 1
- ② Control input 2, feedback loop for switching device 2
- ③ Control input 3 (e.g. for remote trip)
- ④ Switching device 1 of the section switch
- ⑤ Switching device 2 of the section switch
- ⑥ Inverter(s) / generator(s)
- ⑦ Transformer (if applicable)
- ⑧ Public grid

2CDC 252 006 F0014

Electrical connection - CM-UFD.Mxx

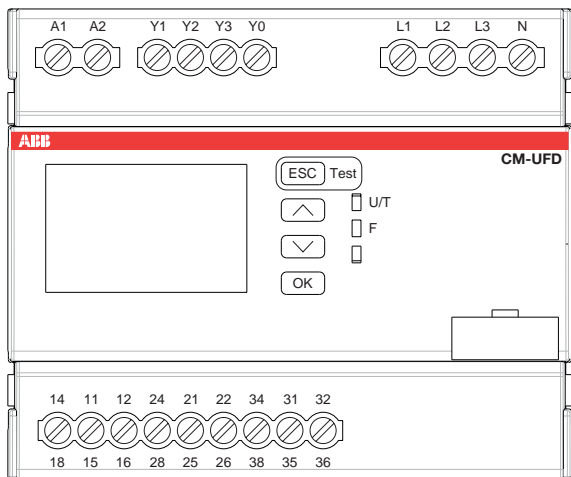

2CDC 252 007 F0014

A1-A2
L1, L2, L3, N
Y1-Y0
Y2-Y0
Y3-Y0

11₁₅-12₁₆/14₁₈
21₂₅-22₂₆/24₂₈
31₃₅-32₃₆/34₃₈

Control supply voltage U_s
Measuring inputs
Control input 1: Feedback from switching device 1
Control input 2: Feedback from switching device 2
Control input 3: Remote trip, suppress Y1, suppress Y2, suppress Y1/Y2 or suppress vector shift detection
Output relay 1: Relay for tripping switching device 1 of the section switch, closed-circuit principle
Output relay 2: Relay for tripping switching device 2 of the section switch, closed-circuit principle
Output relay 3: Closing command for circuit breaker motor, configuration possibilities: closed-circuit principle, open-circuit principle, disabled or synchronous with R1/R2

Grid feeding monitoring relays - Voltage and frequency monitoring functions Ordering and selection



CM-UFD.Mxy



Further documentation grid feeding monitoring relays on www.abb.com

Description

The grid feeding monitoring relays CM-UFD.Mxy are designed to monitor the voltage and the frequency of the public low voltage or medium voltage grid. Whenever the measured values are not within the range of the adjusted threshold values, the CM-UFD.Mxy causes tripping of the section switch (consisting of 1 or 2 switching devices according to the applicable standard). This tripping disconnects the power generation such as photovoltaic systems, wind turbines, block-type thermal power stations from the grid.

Ordering details

Rated control supply voltage = measuring voltage	Standard	Type	Order code	Price 1 pce	Weight (1 pce) kg (lb)
24-240 V AC/DC	CEI 0-21: 2014-09 + CEI 0-21, V1: 2014-1	CM-UFD.M22	1SVR560730R3400		0.225 (0.496)
24-240 V AC/DC	VDE-AR-N 4105 and BDEW	CM-UFD.M31	1SVR560730R3401		0.225 (0.496)
24-240 V AC/DC	G59/3; G83/2	CM-UFD.M33	1SVR560730R3402		0.304 (0.670)
24-240 V AC/DC	DRRG standard of DEWA	CM-UFD.M34	1SVR560730R3403		0.306 (0.675)

	Type	Order number
	CM-UFD.M22	1SVR560730R3400
	CM-UFD.M31	1SVR560730R3401
	CM-UFD.M33	1SVR560730R3402
	CM-UFD.M34	1SVR560730R3403
Rated control supply voltage U_s		
24-240 V AC/DC	<input checked="" type="checkbox"/>	<input checked="" type="checkbox"/>
Standard		
VDE AR-N 4105, BDEW	<input type="checkbox"/>	<input checked="" type="checkbox"/>
G59/3; G83/2	<input type="checkbox"/>	<input checked="" type="checkbox"/>
CEI 0-21	<input checked="" type="checkbox"/>	<input type="checkbox"/>
DRRG standard of DEWA	<input type="checkbox"/>	<input checked="" type="checkbox"/>
Rated frequency		
DC or 50 Hz	<input checked="" type="checkbox"/>	<input checked="" type="checkbox"/>
DC or 50/60 Hz	<input type="checkbox"/>	<input checked="" type="checkbox"/>
Suitable for monitoring		
Single-phase mains	<input checked="" type="checkbox"/>	<input checked="" type="checkbox"/>
Three-phase mains	<input checked="" type="checkbox"/>	<input checked="" type="checkbox"/>
Monitoring function		
Over-/undervoltage	<input checked="" type="checkbox"/>	<input checked="" type="checkbox"/>
Over-/underfrequency	<input checked="" type="checkbox"/>	<input checked="" type="checkbox"/>
ROCOF (rate of change of frequency)	<input checked="" type="checkbox"/>	<input checked="" type="checkbox"/>
10 minutes average value	<input checked="" type="checkbox"/>	<input checked="" type="checkbox"/>
Vector shift	<input type="checkbox"/>	<input checked="" type="checkbox"/>
Thresholds	adj	adj

Grid feeding monitoring relays - Voltage and frequency monitoring functions

Technical data - CM-UFD.Mxx

Technical data

Data at Ta = 25 °C and rated values, unless otherwise indicated

Type		CM-UFD.M22	CM-UFD.M31	CM-UFD.M33
Input circuit - Supply circuit				
Rated control supply voltage U_s		24-240 V AC/DC		
Rated control supply voltage U_s tolerance		-15...+10 %		
Rated frequency		DC or 50 Hz		DC or 50/60 Hz
Frequency range AC		40-60 Hz		40-70 Hz
Typical current / power consumption	24 V DC 230 V AC	64 mA / 1.5 W 6.4 mA / 1.5 VA		
External fusing (necessary)		6 A gG (gL) or circuit breaker 6 A with B characteristic or 6 A Class CC (acc. to UL-requirements)		
Power failure buffering time		200 ms, according to LVFRT (Low Voltage Fault Ride Through)		
Measuring circuit				
Monitoring functions	overvoltage 10-min average (>UAV)	adjustable, 1.00-1.30 * U_s in 0.01* U_s steps	threshold adjustable, 1.000-1.300 * U_n in 0.005 * U_n steps	
	overvoltage (>U1)	adjustable, 1.00-1.20 * U_s in 0.01* U_s steps	threshold adjustable, 1.000-1.300 * U_n in 0.005 * U_n steps	
	overvoltage (>U2)	-	threshold adjustable, 1.000-1.300 * U_n in 0.005 * U_n steps	
	undervoltage (<U1)	adjustable, 0.05-1.00 * U_s in 0.01* U_s steps	threshold adjustable, 0.100-1.000 * U_n in 0.005 * U_n steps	
	undervoltage (<U2)	adjustable, 0.05-1.00 * U_s in 0.01* U_s steps	threshold adjustable, 0.100-1.000 * U_n in 0.005 * U_n steps	
	overfrequency (>F1)	adjustable, 50.0-54.0 Hz in 0.1 Hz steps	threshold adjustable, 50.00-65.00 Hz in 0.01 Hz steps	
	underfrequency (<F2)	adjustable, 46.0-50.0 Hz in 0.1 Hz steps	threshold adjustable, 50.00-65.00 Hz in 0.01 Hz steps	
	overfrequency (>F1)	adjustable, 50.0-54.0 Hz in 0.1 Hz steps	threshold adjustable, 45.00-60.00 Hz in 0.01 Hz steps	
	underfrequency (<F2)	adjustable, 46.0-50.0 Hz in 0.1 Hz steps	threshold adjustable, 45.00-60.00 Hz in 0.01 Hz steps	
	ROCOF	adjustable, 0.1-1.0 Hz/s, in 0.1 Hz/s steps	threshold adjustable, 0.100-5.000 Hz in 0.005 Hz steps	
	vector shift		threshold adjustable, 2.0-40.0 ° in 0.1 ° steps	
	interrupted neutral conductor	enabled if a measuring principle with interrupted neutral conductor is selected		
Measuring ranges	voltage (4-wire system L1, L2, L3-N)	0-312 V AC		0-317 V AC
	(3-wire system L1,L2,L3)	0-540 V AC		0-550 V AC
	(2-wire system L-N)	0-312 V AC		0-317 V AC
	frequency	40-60 Hz		40-70 Hz
Rated frequency of the measuring signal		50 Hz		50/60 Hz
Accuracy of measurements	voltage	≤ 2 %	≤ 0.5 % ± 0.5 V	
	frequency	± 20 mHz	± 20 mHz	
	delay times	≤ 5 % ± 20 ms	≤ 0.1 % ± 20 ms	
Accuracy within the temperature range		$\Delta U \leq 0.02 \text{ %/}^\circ\text{C}$		
Hysteresis related to the threshold value	overvoltage 10-min average	-	adjustable, 0.1-10.0 % in 0.1 % steps	
	overvoltage	0.95-0.97 * U_s	adjustable, 0.5-10.0 % in 0.1 % steps	
	undervoltage	1.03-1.05 * U_s	adjustable, 0.5-10.0 % in 0.1 % steps	
	overfrequency	0.997-0.999 * f_n	adjustable, 0.05-4.00 Hz in 0.01 Hz steps	
	underfrequency	1.001-1.003 * f_n	adjustable, 0.05-4.00 Hz in 0.01 Hz steps	
Reaction time acc. CEI 0-21 chapter A.4.3		CM-UFD.M22: adjustable, 0.05-600.00 s in 0.05 s steps, ±3 % ±20 ms for: Overvoltage 2, Undervoltage 1, Undervoltage 2, Overfrequency 1, Overfrequency 2, Underfrequency 1, Underfrequency 2		
Measuring cycle	ROCOF	640 ms at 50 Hz	adjustable, 4-50 periods	

Grid feeding monitoring relays - Voltage and frequency monitoring functions

Technical data - CM-UFD.Mxx

2

Type	CM-UFD.M22	CM-UFD.M31	CM-UFD.M33
Control circuits			
Number	3		
Type of triggering	volt-free triggering, signal source Y0		
Function of the control inputs	Y1-Y0 Control input 1	DDI feedback, trip and release monitoring times adjustable	feedback from switching device 1
	Y2-Y0 Control input 2	External signal	feedback from switching device 2
	Y3-Y0 Control input 3	Remote trip	remote trip; suppression of Y1, Y2, Y1/Y2 or vector shift detect.
Electrical isolation	from supply voltage	yes	
	from the measuring circuit	no	
	from the relay outputs	yes	
Max. switching current in the control circuit	6 mA		
No-load voltage at the control inputs (V0-V1, V2, V3)	22-26 V DC		
Minimum control pulse length	20 ms		
Max. cable length at the control inputs (unshielded)	10 m		
Timing functions			
Start-up delay, R1 (prior to first grid connection or re-connection after interruption)	adjustable, 1.00-600.00 s in 0.05 s steps	-	
Restart delay, R1	adjustable, 0.05-600.00 s in 0.05 s steps	-	
Start-up delay, R2 (prior to first grid connection or re-connection after interruption)	1 s, fixed	-	
ON-delay, R3	adjustable, 0.00-10.00 s in 0.05 s steps	-	
ON-time, R3	adjustable, 0.05-10.00 s in 0.05 s steps	-	
Trip window, feedback loop Y1	adjustable, 0.05-0.50 s in 0.05 s steps	-	
Release window, feedback loop Y1	adjustable, 0.50-600.00 s in 0.05 s steps	-	
Tripping delays	adjustable, 0.05-600.00 s in 0.05 s steps	-	
ROCOF error time	-	-	
Switch-on delay (prior to first grid connection or reconnection after interruption)	-	adjustable, 0.05-600.00 s in 0.01 s steps	
Tripping delay	overvoltage 10-min average ($>U_{AV}$)	-	< 3 s
	overvoltage ($>U1, >U2$)	-	adjustable, 0.00-600.00 s in 0.01 s steps; +50 ms / -0 ms
	undervoltage ($<U1, <U2$)	-	
	overfrequency ($>F1, >F2$)	-	
	underfrequency ($<F1, <F2$)	-	
	ROCOF	-	
	vector shift	-	< 50 ms
	interrupted neutral conductor	< 150 ms	
Error time	ROCOF	-	adjustable, 0.5-600.00s in 0.01 s steps
	vector shift	-	adjustable, 0.5-600.00s in 0.01 s steps
Trip window (feedback loops Y1-Y0, Y2-Y0)	-	-	adjustable, 0.05-0.50 s in 0.01 s steps
Release window (feedback loops Y1-Y0, Y2-Y0)	-	-	adjustable, 0.50-600.00 s in 0.01 s steps
Time error within the temperature range	-	-	$\Delta t \leq 0.01 \%$
User interface - Indication of operational states			
Control supply voltage applied / timing	U/T	LED green on / flashing	
Fault message	F	LED red on	
For details see the message on the display			
User interface - Display			
Back light	on	press any button	
	off	switch-off delay adjustable, 10-600 s (default 10 s)	
Operating temperature range of the display	clearly visible	-20...+60 °C	
Resolution		112 x 64 pixel	
Display size		36 x 22 mm	
User interface - Operating elements			
4 push-buttons for menu navigation, setting and entering			

Grid feeding monitoring relays - Voltage and frequency monitoring functions

Technical data - CM-UFD.Mxx

2

Type		CM-UFD.M22	CM-UFD.M31	CM-UFD.M33
Output circuits				
Kind of outputs	11-12/14 (15-16/18) 21-22/24 (25-26/28) 31-32/34 (35-36/38)	1st c/o (SPDT) contact, tripping relay for switching device 1 (DDI) 2nd c/o (SPDT) contact, tripping relay for switching device 2 (DG) 3rd c/o (SPDT) contact, closing command for breaker motor		
Operating principle	11-12/14 21-22/24 31-32/34	closed-circuit principle open- or closed-circuit principle principle configurable		
Contact material		AgNi alloy, Cd-free		
Rated operational voltage U_e	IEC/EN 60947-1	250 V	300 V	
Minimum switching voltage / minimum switching current		24 V / 10 mA		
Maximum switching voltage / maximum switching current		see load limit curves		
Rated operational current I_e (IEC/EN 60947-5-1)	AC-12 (resistive) at 230 V AC-15 (inductive) at 230 V DC-12 (resistive) at 24 V DC-13 (inductive) at 24 V	4 A 3 A 4 A 2 A		
Mechanical lifetime		30 x 10 ⁶ switching cycles		
Electrical lifetime	at AC12, 230 V AC, 4 A	50 x 10 ³ switching cycles		
Maximum fuse rating to achieve short-circuit protection	n/c contact	10 A fast-acting	10 A fast-acting or circuit breaker 10 A with B characteristic	
	n/o contact	10 A fast-acting	10 A fast-acting or circuit breaker 10 A with B characteristic	
Maximum closing current (short time)	t < 20 ms t < 80 ms	30 A 17 A		
Conventional thermal current I_{th}	IEC/EN 60947-1	5 A		
General data				
MTBF		on request		
Repeat accuracy (constant parameters)		< ±0.5 %		
Duty time		100 %		
Dimensions (W x H x D)	product dimensions	108 x 90 x 67 mm (4.25 x 3.54 x 2.64 in)		
	packaging dimensions	121 x 99 x 71 mm (4.76 x 3.90 x 2.80 in)		
Weight	net weight	0.306 kg (0.675 lb)		
	gross weight	0.360 kg (0.794 lb)		
Material of housing		PA666FR		
Mounting		DIN rail (IEC/EN 60715) TH 35-7.5 and TH 35-15, snap-on mounting without any tool		
Mounting position		any		
Minimum distance to other units	horizontal / vertical	not necessary		
Degree of protection	housing / terminals	IP20		
Electrical connection				
Wire size	fine-strand with wire end ferrule	1 x 0.25-4 mm ² (1 x 24-12 AWG), 2 x 0.25-0.75 mm ² (2 x 24-18 AWG)		
	fine-strand without wire end ferrule	1 x 0.2-4 mm ² (1 x 24-12 AWG), 2 x 0.2-1.5 mm ² (2 x 24-16 AWG)		
	rigid	1 x 0.2-6 mm ² (1 x 24-10 AWG), 2 x 0.2-1.5 mm ² (2 x 24-16 AWG)		
Stripping length		8 mm (0.31 in)		
Tightening torque		0.5-0.6 Nm (4.4 -5.3 lb.in)		
Environmental data				
Ambient temperature ranges	operation	-20...+60 °C		
	storage	-20...+80 °C		
Climatic class (EN 50178)		3K5 (w/o condensation, w/o icing)		
Damp heat, cyclic (IEC/EN 60068-2-30)		6 x 24 h cycle, 55 °C, 95 % RH		
Vibration, sinusoidal (IEC/EN 60255-21-1)		Class 2		
Shock (IEC/EN 60255-21-2)		Class 2		

Grid feeding monitoring relays - Voltage and frequency monitoring functions

Technical data - CM-UFD.Mxx

2

Type		CM-UFD.M22	CM-UFD.M31	CM-UFD.M33
Isolation data				
Rated insulation voltage U_i (IEC/EN 60947-1, IEC/EN 60664-1)	supply/measuring/output circuits	600 V		
	output 1/output 2/output 3	300 V		
Rated impulse withstand voltage U_{imp} (IEC/EN 60947-1, IEC/EN 60664-1)	supply/measuring/output circuits	6 kV; 1.2/50 μ s		
	output 1/output 2/output 3	4 kV; 1.2/50 μ s		
Basic insulation acc. rated control supply voltage (IEC/EN 60664-1)	supply/measuring/output circuits	600 V		
	output 1/output 2/output 3	300 V		
Protective separation acc. rated voltage (IEC/EN 61140)	supply/measuring/output circuits	250 V		
	output 1/output 2/output 3	250 V		
Test voltage, routine test (IEC/EN 60255-5)	supply/measuring/output circuits	2.2 kV, 50 Hz, 1 s		
	output 1/output 2/output 3	2.2 kV, 50 Hz, 1 s		
Test voltage, type test (CEI 0-21)	supply/measuring /output circuits	5 kV, 50 Hz, 1 s	-	
	output 1/output 2/output 3	4 kV, 50 Hz, 1 s	-	
Pollution degree (IEC/EN 60664-1)		3		
Overvoltage category (IEC/EN 60664-1)		III		
Overvoltage category according to CEI 0-21		IV	-	
Standard				
Product standard		IEC/EN 60255-1		
Electrical safety		-	-	UL 508, CAN/CSA C22.2 No.14
Application standards		CEI 0-21: 2012-06 + CEI 0-21; V1: 2012-12 + A70 Terna	VDE-AR-N 4105: 2011-08; BDEW, June 2008 "Technische Richtlinie – Erzeugungsanlagen am Mittelspannungsnetz" including supplementary provisions of January 2013	Engineering Recommendation G59 Issue 3 - September 2013; Engineering Recommendation G83 Issue 2 - December 2012
Low Voltage Directive		2006/95/EC		
EMC Directive		2004/108/EC		
RoHS Directive		2011/65/EC		
Electromagnetic compatibility				
Interference immunity to				IEC/EN 61000-6-1, IEC/EN 61000-6-2
electrostatic discharge	IEC/EN 61000-4-2			Level 3 (6 kV / 8 kV)
radiated, radio-frequency, electromagnetic field	IEC/EN 61000-4-3			Level 3, 10 V/m
electrical fast transient/burst	IEC/EN 61000-4-4			Level 3, 2 kV / 5 kHz
surge	IEC/EN 61000-4-5			Level 3, installation class 3, supply and measuring input 1 kV L-L, 2 kV L-earth
conducted disturbances, induced by radio-frequency fields	IEC/EN 61000-4-6			Level 3, 10 V
voltage dips, short interruptions and voltage variations	IEC/EN 61000-4-11			Class 3
harmonics and interharmonics	IEC/EN 61000-4-13			Class 3
Interference emission				IEC/EN 61000-6-3, IEC/EN 61000-6-4
high-frequency radiated	IEC/CISPR 22, EN 55022			Class B
high-frequency conducted	IEC/CISPR 22, EN 55022			Class B

Insulation monitoring relays for unearthed supply systems

Product group picture

2



Insulation monitoring relays for unearthed supply systems

Table of contents

Insulation monitoring relays for unearthed supply systems

Insulation monitoring relays for unearthed supply systems	110
Benefits and advantages	111
Benefits and advantages, Applications	112
Operating controls	113
Insulation monitoring in IT systems	114
Selection table	115
Ordering details	116
Operating state indication, Connection diagrams, DIP switches	117
Technical data - CM-IWx	118
Technical data CM-IVN	121

Insulation monitoring relays for unearthed supply systems

Benefits and advantages

2



CM-IWS.1



CM-IWS.2



CM-IWN

Insulation monitoring relays for unearthed pure AC systems:

Characteristics CM-IWS.1

- For monitoring the insulation resistance of unearthed IT systems up to $U_n = 250$ V AC and 300 V DC
- According to IEC/EN 61557-8
- Rated control supply voltage 24-240 V AC/DC
- Prognostic measuring principle with superimposed square wave signal
- One measuring range 1-100 k Ω
- 1 c/o (SPDT) contact, closed-circuit principle
- Precise adjustment by front-face operating controls in 1 k Ω steps
- Interrupted wire detection
- Fault storage / latching configurable by control input
- Screw connection technology or Easy Connect Technology available
- Housing material for highest fire protection classification UL 94 V-0
- Tool-free mounting on DIN rail as well as demounting
- 22.5 or 45 mm width
- 3 LEDs for status indication

Characteristics CM-IWN.1

- For monitoring the insulation resistance of unearthed IT systems up to $U_n = 400$ V AC and 600 V DC
- According to IEC/EN 61557-8
- Rated control supply voltage 24-240 V AC/DC
- Prognostic measuring principle with superimposed square wave signal
- Two measuring ranges 1-100 k Ω and 2-200 k Ω
- Precise adjustment of the measuring value in 1 or 2 k Ω steps
- One (1 x 2 c/o) or two (2 x 1 c/o) threshold values $R_{an1}/R1$ (warning) and $R_{an2}/R2$ (prewarning) configurable¹⁾
- Precise adjustment of the threshold values in 1 k Ω steps (R1) and 2 k Ω steps (R2)
- Interrupted wire detection configurable
- Non-volatile fault storage configurable
- Open- or closed-circuit principle configurable
- Screw connection technology or Easy Connect Technology available
- Housing material for highest fire protection classification UL 94 V-0
- Tool-free mounting on DIN rail as well as demounting
- 45 mm (1.77 in) width
- 3 LEDs for status indication

¹⁾R2 only active with 2 x 1 c/o configuration

Insulation monitoring relays for unearthed AC, DC or mixed AC/DC systems:

Characteristics CM-IWS.2

- For monitoring the insulation resistance of unearthed IT systems up to $U_n = 400$ V AC
- According to IEC/EN 61557-8
- Rated control supply voltage 24-240 V AC/DC
- Measuring principle with superimposed DC voltage
- One measuring range 1-100 k Ω
- Fault storage / latching configurable by control input
- Precise adjustment by front-face operating controls in 1 k Ω steps
- Screw connection technology or Easy Connect Technology available
- Housing material for highest fire protection classification UL 94 V-0
- Tool-free mounting on DIN rail as well as demounting
- 1 c/o (SPDT) contact, closed-circuit principle
- 22.5 mm (0.89 in) width
- 3 LEDs for the indication of operational states

Characteristics CM-IWN.4,5,6

Follows in parts the standard of IEC/EN 61557-8 (see data sheet for details):

- For monitoring the insulation resistance of unearthed IT systems up to $U_n = 400$ V AC and 600 V DC
- Specifically for applications with high system leakage capacitances
- Rated control supply voltage 24-240 V AC/DC
- Prognostic measuring principle with superimposed square wave signal
- Two measuring ranges 1-100 k Ω and 2-200 k Ω
- Precise adjustment of the measuring value in 1 or 2 k Ω steps
- One (1 x 2 c/o) or two (2 x 1 c/o) threshold values $R_{an1}/R1$ (warning) and $R_{an2}/R2$ (prewarning) configurable¹⁾
- Precise adjustment of the threshold values in 1 k Ω steps (R1) and 2 k Ω steps (R2)
- Interrupted wire detection configurable
- Non-volatile fault storage configurable
- Open- or closed-circuit principle configurable
- Screw connection technology or Easy Connect Technology available
- Housing material for highest fire protection classification UL 94 V-0
- Tool-free mounting on DIN rail as well as demounting
- 45 mm (1.77 in) width
- 3 LEDs for status indication

¹⁾R2 only active with 2 x 1 c/o configuration

Insulation monitoring relays for unearthed supply systems

Benefits and advantages, Applications

Application / monitoring function CM-IWx

The CM-IWx serve to monitor insulation resistance in unearthed IT AC systems, IT AC systems with galvanically connected DC circuits, or unearthed IT DC systems. The insulation resistance between system lines and system earth is measured. If this falls below the adjustable threshold values, the output relay(s) energize or de-energize. The CM-IWS.x can monitor control circuits (single-phase) and main circuits (3-phase). Supply systems with voltages $U_n = 0-400$ V AC (45-65 Hz), $U_n = 0-250$ V AC (15-400 Hz) or 0-300 V DC can be directly connected. For systems with voltages above 400 V AC the insulation monitoring relay with or without the coupling unit CM-IVN can be used.

Application / monitoring function CM-IWN.x

The CM-IWN.x serves to monitor insulation resistance in unearthed IT AC systems, IT AC systems with galvanically connected DC circuits, or unearthed IT DC systems. The insulation resistance between system lines and system earth is measured. If this falls below the adjustable threshold values, the output relays switch into the fault state. The device can monitor control circuits (single-phase) and main circuits (3-phase). Supply systems with voltages $U_n = 0-400$ V AC (15-400 Hz) or 0-600 V DC can be directly connected to the measuring inputs and their insulation resistance being monitored. For systems with voltages above 400 V AC and 600 V DC the coupling unit CM-IVN can be used for the expansion of the CM-IWN.x voltage range.

Expansion of assortment for the requirements of decentral electrical energy sources

ABB's insulation monitoring relays from the CM-IWN range provide higher system leakage capacitances. This expanded product range covers the requirements of decentral electrical sources.

The range of system leakage capacitances is 20 - 2000 μ F.

Application / monitoring function CM-IVN

The coupling unit CM-IVN is designed to extend the nominal voltage range of the insulation monitoring relay CM-IWN.1 up to 690 V AC and 1000 V DC. The coupling unit can be connected to the system to be monitored by means of the terminals VL+ and VL-. The terminal Vw has to be connected to the earth potential. The terminals L+, V1+, L-, V1-, VS and VE have to be connected to the CM-IWN.1 as shown in the connection diagrams below. Supply systems with voltages $U_n = 0-690$ V AC (15-400 Hz) or 0-1000 V DC can be connected.

Measuring principle CM-IWS.2

A superimposed DC measuring signal is used for measurement. From the superimposed DC measuring voltage and its resultant current the value of the insulation resistance of the system to be monitored is calculated.

Measuring principle CM-IWN.x, CM-IWS.1

A pulsating measuring signal is fed into the system to be monitored and the insulation resistance is calculated. This pulsating measuring signal alters its form depending on the insulation resistance and system leakage capacitance. From this altered form the change in the insulation resistance is forecast. When the forecast insulation resistance corresponds to the insulation resistance calculated in the next measurement cycle and is smaller than the set threshold value, the output relay de-energizes. This measuring principle is also suitable for the detection of symmetrical insulation faults.



Insulation monitoring relays for unearthed supply systems

Operating controls

2

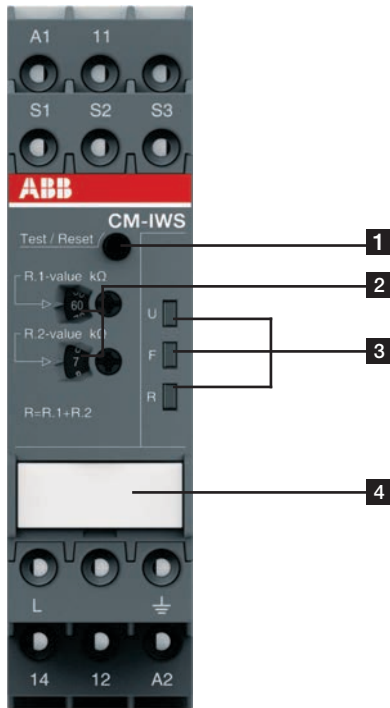

- 1 Test and reset button**
- 2 Configuration and setting**
 Front-face rotary switches for threshold value adjustment:
 R.1 for R1 tens figures:
 0, 10, 20, 30, 40, 50, 60, 70, 80, 90 kΩ in ten kΩ steps
 R.2 for R1 units figures:
 1, 2, 3, 4, 5, 6, 7, 8, 9, 10 kΩ in one kΩ steps
- 3 Indication of operational states**
 U: green LED - control supply voltage
 F: red LED - fault message
 R: yellow LED - relay status
- 4 Marker label for devices without DIP switches**

2CDC 253 021 FO013

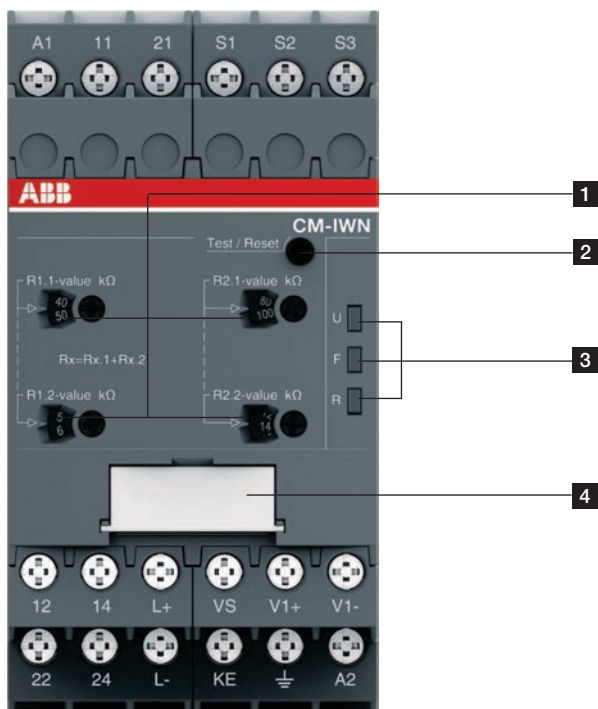

- 1 Front-face rotary switches to adjust the threshold value:**
 R1.1 for R1 tens figure:
 0, 10, 20, 30, 40, 50, 60, 70, 80, 90 kΩ in ten kΩ steps
 R1.2 for R1 units figure:
 1, 2, 3, 4, 5, 6, 7, 8, 9, 10 kΩ in one kΩ steps
 R2.1 for R2 tens figure:
 0, 20, 40, 60, 80, 100, 120, 140, 160, 180 kΩ in twenty kΩ steps
 R2.2 for R2 units figure:
 2, 4, 6, 8, 10, 12, 14, 16, 18, 20 kΩ in two kΩ steps
- 2 Test and reset button**
- 3 Indication of operational states**
 U: green LED – control supply voltage
 F1: red LED – fault message
 F2: yellow LED – relay status
- 4 DIP switches (see DIP switch functions)**

2CDC 253 015 FO013

Insulation monitoring relays for unearthed supply systems

Insulation monitoring in IT systems

In electricity supply systems, an earthing system defines the electrical potential of the conductors relative to that of the earth's conductive surface. The choice of earthing system has implications for the safety and electromagnetic compatibility of the power supply. Note that regulations for earthing (grounding) systems vary considerably among different countries.

The international standard IEC 60364 distinguishes three families of earthing arrangements, using the two-letter codes TN, TT and IT.

The first letter indicates the connection between earth and the power-supply equipment (generator or transformer):

T: direct connection of a point with earth (Latin: terra)

I: no point is connected with earth (insulation), except perhaps via a high impedance

The second letter indicates the connection between earth and the electrical device being supplied:

T: direct connection of a point with earth

N: direct connection to neutral at the origin of installation, which is connected to the earth

IT supply systems

The IT system is supplied either by an isolation transformer or a voltage source, such as battery or a generator.

In this system no active conductor is directly connected to earth potential. The advantage of this is that only a small fault current can flow in case of an insulation fault. This current is essentially caused by the leakage capacitance of the system.

The fuse of the system or MCB does not respond, thus maintaining the voltage supply and therefore operation even in case of a phase-to-earth fault.

The high reliability of an IT system is guaranteed thanks to continuous insulation monitoring.

The insulation monitoring device recognizes insulation faults as they develop, and immediately reports that the value has fallen below the minimum. This prevents operational interruptions caused by a second more severe insulation fault.

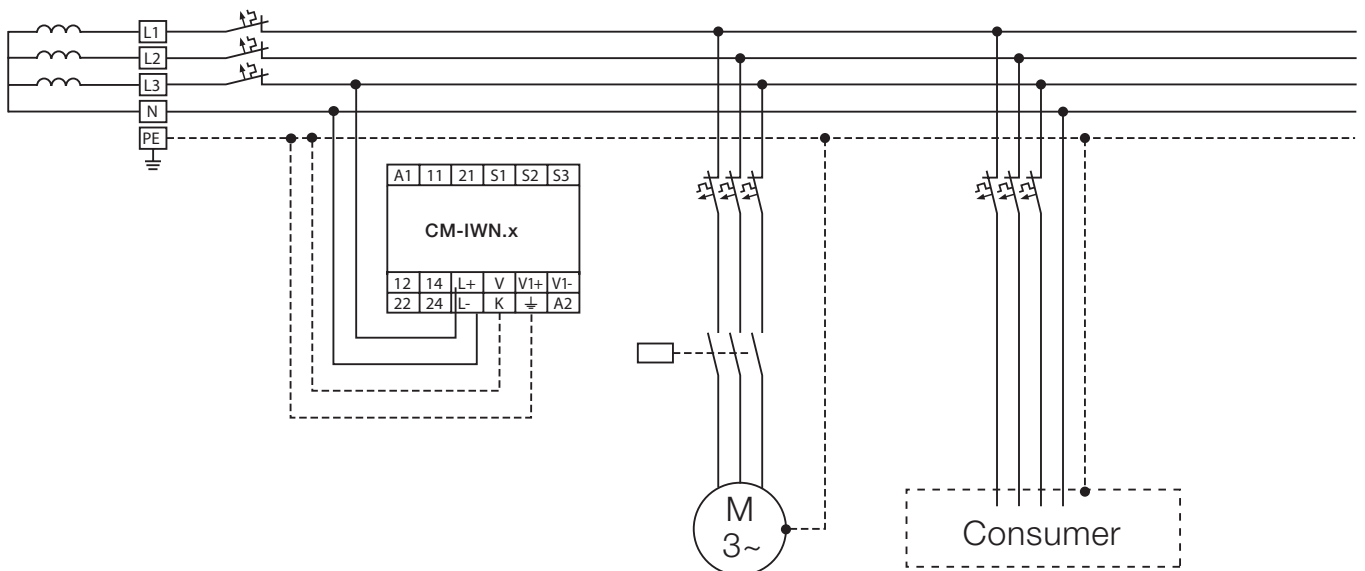

Insulation monitoring relays for unearthed supply systems

Selection table

2

Type	Order number	CM-IWS.2S	CM-IWS.2P	CM-IWS.1S	CM-IWS.1P	CM-IVN.1S	CM-IVN.1P	CM-IVN.4S	CM-IVN.4P	CM-IVN.5S	CM-IVN.5P	CM-IVN.6S	CM-IVN.6P
		1SVR730670R0200	1SVR740670R0200	1SVR730660R0100	1SVR740660R0100	1SVR750660R0200	1SVR760660R0200	1SVR750660R0300	1SVR760660R0300	1SVR750660R0400	1SVR760660R0400	1SVR750660R0500	1SVR760660R0500
Rated control supply voltage U_s													
24 - 240 VAC/DC		■	■	■	■	■	■	■	■	■	■	■	■
Measuring voltages													
250 V AC (L-PE)				■	■								
400 V AC (L-PE)		■	■			■	■	■	■	■	■	■	■
690 V AC (L-PE)						■ ¹⁾	■ ¹⁾	■ ¹⁾	■ ¹⁾	■ ¹⁾	■ ¹⁾	■ ¹⁾	■ ¹⁾
300 V DC (L-PE)				■	■								
600 V DC (L-PE)						■	■	■	■	■	■	■	■
1000 V DC (L-PE)						■ ¹⁾	■ ¹⁾	■ ¹⁾	■ ¹⁾	■ ¹⁾	■ ¹⁾	■ ¹⁾	■ ¹⁾
Measuring range													
1 - 100 k Ω		■	■	■	■	■	■	■	■	■	■	■	■
2 - 200 k Ω						■	■	■	■	■	■	■	■
System leakage capacitance, max.													
10 μ F		■	■	■	■								
20 μ F						■	■						
500 μ F								■	■				
1000 μ F										■	■		
2000 μ F												■	■
Output													
1 c/o		■	■	■	■								
1 x 2 c/o or 2 x 1 c/o						■	■	■	■	■	■	■	■
Operating principle													
Open-circuit principle		■	■	■	■								
Open- or closed-circuit principle adjustable						■	■	■	■	■	■	■	■
Test													
Front-face button or control input		■	■	■	■	■	■	■	■	■	■	■	■
Reset													
Front-face button or control input		■	■	■	■	■	■	■	■	■	■	■	■
Fault storage / latching configurable		■	■	■	■	■	■	■	■	■	■	■	■
Non volatile storage configurable		■	■	■	■	■	■	■	■	■	■	■	■
Interrupted wire detection						■	■	■	■	■	■	■	■
Threshold values configurable		1	1	1	1	2	2	2	2	2	2	2	2
Connection type													
Push-in terminals			■		■		■		■		■		■
Double-chamber cage connection terminals		■		■		■		■		■		■	

¹⁾ With coupling unit CM-IVN screw version CM-IVN.S: 1SVR750669R9400 push-in version CM-IVN.P: 1SVR760669R9400

Insulation monitoring relays for unearthed supply systems

Ordering details



CM-IWS.1



CM-IWS.2



CM-IWN.1



CM-IVN

Description

The CM-IWx serves to monitor insulation resistance in accordance with IEC 61557-8 in unearthed IT AC systems, IT AC systems with galvanically connected DC circuits, or IT AC systems.

The devices are able to monitor control circuits (single-phase) and main circuits (3-phase).

Ordering details

Rated control supply voltage = measuring voltage	Nominal voltage U_n of the distribution system to be monitored	System leakage capacitance, max.	Adjustment range of the specified response value R_{an} (threshold)	Type	Order code	Price	Weight (1 pce)	
						1 pce	kg (lb)	
24-240 V AC/DC	0-250 V AC / 0-300 V DC	10 μ F	1-100 k Ω	CM-IWS.1S	1SVR730660R0100		0.148 (0.326)	
				CM-IWS.1P	1SVR740660R0100		0.137 (0.302)	
	CM-IWS.2S			1SVR730670R0200		0.141 (0.311)		
	CM-IWS.2P			1SVR740670R0200		0.130 (0.287)		
	0-400 V AC			20 μ F	CM-IWN.1S	1SVR750660R0200		0.241 (0.531)
					CM-IWN.1P	1SVR760660R0200		0.217 (0.478)
500 μ F		CM-IWN.4S	1SVR750660R0300		0.241 (0.531)			
		CM-IWN.4P	1SVR760660R0300		0.217 (0.478)			
		1000 μ F	CM-IWN.5S	1SVR750660R0400		0.241 (0.531)		
			CM-IWN.5P	1SVR760660R0400		0.217 (0.478)		
2000 μ F	CM-IWN.6S	1SVR750660R0500		0.241 (0.531)				
	CM-IWN.6P	1SVR760660R0500		0.217 (0.478)				

Ordering details - Coupling unit

Rated control supply voltage = measuring voltage	Nominal voltage U_n of the distribution system to be monitored	Type	Order code	Price	Weight (1 pce)
				1 pce	kg (lb)
Passive device, no control supply voltage needed	0-690 V AC / 0-1000 V DC	CM-IVN.S	1SVR750669R9400		0.179 (0.395)
		CM-IVN.P	1SVR760669R9400		0.165 (0.364)

S: screw connection
P: push-in connection



Further documentation insulation monitoring relays on www.abb.com

Insulation monitoring relays for unearthed supply systems

Operating state indication, Connection diagrams, DIP switches

LEDs, status information and fault messages CM-IWN.x

Operational state	LED U (green)	LED F (red)	LED R (yellow)
Start-up		OFF	OFF
No fault		OFF	1)
Prewarning			
Insulation fault (below threshold value)			1)
KE/⚡ wire interruption			1)
L+/L- wire interruption during system start-up / test function			1)
System leakage capacitance too high / invalid measurement result			1)
Internal system fault	1)		1)
Setting fault ²⁾			
Test function		OFF	1)
No fault after fault storage ³⁾		4)	

¹⁾ Depending on the configuration.

²⁾ Possible faulty setting: The threshold value for final switch-off is set at a higher value than the threshold value for prewarning

³⁾ The device has triggered after an insulation fault. The fault has been stored and the insulation resistance has returned to a higher value than the threshold value plus hysteresis.

⁴⁾ Depending on the fault

LEDs, status information and fault messages CM-IWS.x

Operational state	LED U (green)	LED F (red)	LED R (yellow)
Start-up		OFF	OFF
No fault		OFF	
Insulation fault (below threshold value)			OFF
Invalid measuring result			OFF
KE/⚡ wire interruption (only CM-IWS.1)			OFF
CM-IWS.1: System leakage capacitance too high / invalid measurement result			OFF
CM-IWS.2: Invalid measurement result			OFF
Internal system fault	OFF		OFF
Test function		OFF	OFF
No fault after fault storage ³⁾		4)	

Connection diagram CM-IWS.2

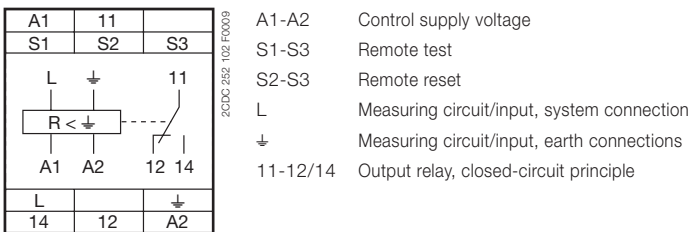

Connection diagram CM-IWS.1

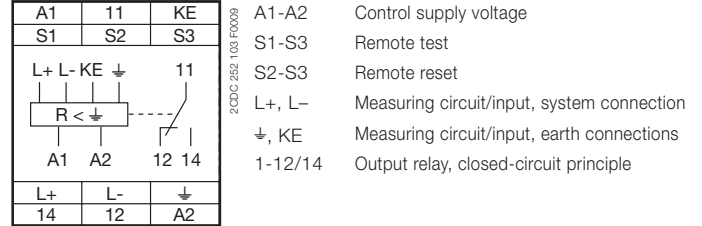

Connection diagram CM-IWN.1, 4, 5, 6

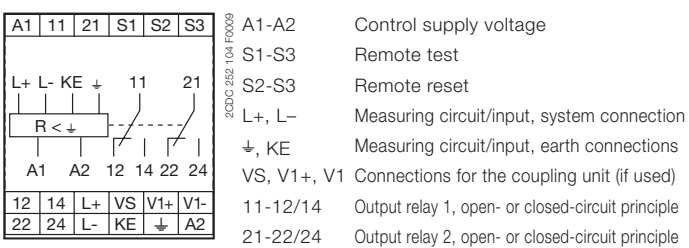

Connection diagram CM-IVN

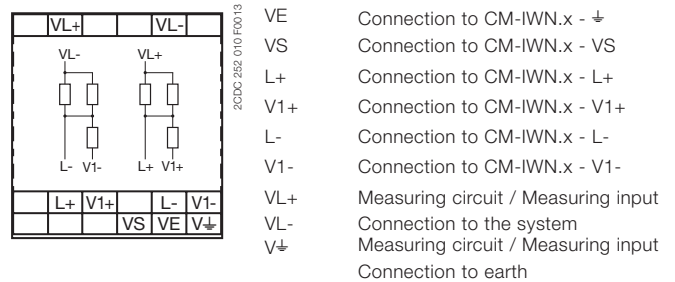

DIP switches of CM-IWN.1, 4, 5, 6

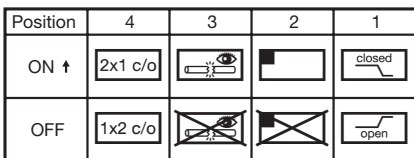

2CDC 252 050 F0009

	ON	OFF (default)
DIP switch 1 Operating principle of the output relays	Closed-circuit principle If closed-circuit principle is selected, the output relays de-energize in case a fault is occurring. In non-fault state the relays are energized.	Open-circuit principle If open-circuit principle is selected, the output relays energize in case a fault is occurring. In non-fault state the relays are de-energized.
DIP switch 2 Non-volatile fault storage	Fault storage activated (latching) If the fault storage function is activated, the output relays remain in tripped position until a reset is done either by the front-face button or by the remote reset connection S2-S3. This function is non-volatile.	Fault storage de-activated (non latching) If the fault storage function is de-activated, the output relays switch back to their original position as soon as the insulation fault no longer exists.
DIP switch 3 Interrupted wire detection	Interrupted wire detection activated With this configuration, the CM-IWN.1 monitoring relays the wires connected to + and KE for interruptions.	Interrupted wire detection de-activated With this configuration, the interrupted wire detection is de-activated.
DIP switch 4 2 x 1 c/o, 1 x 2 c/o	2 x 1 c/o (SPDT) contact If operating principle 2 x 1 c/o contact is selected, the output relay R1 (11-12/14) reacts to threshold value R1 (final switch-off) and the output relay R2 (21-22/24) reacts to threshold value R2 (prewarning)	1 x 2 c/o (SPDT) contacts If operating principle 1 x 2 c/o contacts is selected, both output relays R1 (11-12/14) and R2 (21-22/24) react synchronously to threshold value R1. Settings of the threshold value R2 have no effect on the operation.

Insulation monitoring relays for unearthed supply systems

Technical data - CM-IWx

Data at $T_a = 25\text{ °C}$ and rated values, unless otherwise indicated

	CM-IWS.2	CM-IWS.1	CM-IWN.1, 4, 5, 6
Input circuit - Supply circuit			
Rated control supply voltage U_s	24-240 V AC/DC		
Rated control supply voltage tolerance	-15...+10 %		
Typical current / power consumption	24 V DC 115 V AC 230 V AC	30 mA / 0.7 VA 12 mA / 1.4 VA 12 mA / 2.8 VA	35 mA / 0.9 VA 17 mA / 2.0 VA 14 mA / 3.2 VA
Rated frequency f_s	DC or 15-400 Hz		
Frequency range AC	13.5-440 Hz		
Power failure buffering time	min. 20 ms		
Input circuit - Measuring circuit			
Monitoring function	insulation resistance monitoring of IT systems		
Measuring principle	superimposed DC voltage		
Nominal voltage U_n of the distribution system to be monitored	0-400 V AC	0-250 V AC / 0-300 V DC	0-400 V AC / 0-600 V DC
Voltage range of the distribution system to be monitored	0-460 V AC (tolerance +15 %)	0-287.5 V AC / 0-345 V DC (tolerance +15 %)	0-460 V AC / 0-690 V DC (tolerance +15 %)
Rated frequency f_N of the distribution system to be monitored	50-60 Hz	DC or 15-400 Hz	DC or 15-400 Hz
System leakage capacitance C_e	max. 10 μ F		CM-IWN.1: 20 μ F CM-IWN.4: 500 μ F CM-IWN.5: 1000 μ F CM-IWN.6: 2000 μ F
Tolerance of the rated frequency f_N	45-65 Hz	13.5-440 Hz	13.5-440 Hz
Extraneous DC voltage U_{ig} (when connected to an AC system)	max. none	290 V DC	460 V DC
Number of possible response / threshold values	1		2
Adjustment range of the specified response value R_{an} (threshold)	min.-max. 1-100 Ω min.-max. R1 - min.-max. R2 -		1-100 k Ω 2-200 k Ω (activated / de-activated by DIP- switch)
Adjustment resolution	1 k Ω R1 1 k Ω R2 -		1 k Ω 2 k Ω
Tolerance of the adjusted threshold value / Relative percentage uncertainty A at -5...+45 °C, $U_n = 0-115\%$, $U_s = 85-110\%$, $f_N, f_s, C_e = 1\mu$ F	at 1-10 k Ω R_F $\pm 0.5\%$ at 10-100 k Ω R_F $\pm 6\%$ at 1-15 k Ω R_F - at 15-200 k Ω R_F -		- - $\pm 1\text{ k}\Omega^*$ $\pm 8\%$
Hysteresis related to the threshold value	25 %; min. 2 k Ω		
Internal impedance Z_i	at 50 Hz 135 k Ω	100 k Ω	155 k Ω
Internal DC resistance R_i	185 k Ω		
Measuring voltage U_m	15 V	22 V	24 V
Tolerance of measuring voltage U_m	+10 %		
Measuring current I_m	max. 0.1 mA	0.3 mA	0.15 mA
Response time t_{an}	pure AC system 0.5 x R_{an} and $C_e = 1\mu$ F DC system or AC system with connected rectifiers	max. 10 s -	max. 15 s
Repeat accuracy (constant parameters)	< 0.1 % of full scale		
Accuracy of R_a (measured value) within the rated control supply voltage tolerance	< 0.05 % of full scale		
Accuracy of R_a (measured value) within the operation temperature range	at 1-10 k Ω R_F 5 Ω / K at 10-100 k Ω R_F 0.05 % / K at 10-200 k Ω R_F -		- 0.05 % / K
Transient overvoltage protection (\downarrow - terminal)	Z-diode	avalanche diode	
Input circuit - Control circuits			
Control inputs - volt free	S1-S3 S2-S3	remote test remote reset	
Maximum switching current in the control circuit	1 mA		
Maximum cable length to the control inputs	50 m - 100 pF/m [164 ft - 30.5 pF/ft]		
Minimum control pulse length	150 ms		
No-load voltage at the control input	$\leq 24\text{ V} \pm 5\%$		$\leq 24\text{ V DC}$
Indication of operational states			
Control supply voltage	LED U (green)		
Fault message	LED F (red)		
Relay status	LED R (yellow)		

*in combination with CM-IVN $\pm 1.5\text{ k}\Omega$

Insulation monitoring relays for unearthed supply systems

Technical data - CM-IWx

2

		CM-IWS.2	CM-IWS.1	CM-IWN.1, 4, 5, 6
Output circuits				
Kind of output		relay, 1 c/o (SPDT) contact		2 x 1 or 1 x 2 c/o (SPDT) contacts configurable
Operating principle		closed-circuit principle ¹⁾		open- or closed circuit principle ¹⁾ configurable
Contact material		AgNi alloy, Cd free		
Rated voltage (VDE 0110, IEC 60947-1)		250 V AC / 300 V DC		
Min. switching voltage / Min. switching current		24 V / 10 mA		
Max. switching voltage / Max. switching current		see data sheet		
Rated operational current I _o (IEC/EN 60947-5-1)	AC-12 (resistive) at 230 V	4 A		
	AC-15 (inductive) at 230 V	3 A		
	DC-12 (resistive) at 24 V	4 A		
	DC-13 (inductive) at 24 V	2 A		
AC rating (UL 508)	Utilization category (Control Circuit Rating Code)	B 300, pilot duty general purpose (250 V, 4 A, cos φ 0.75)		
	max. rated operational voltage	250 V AC		
	max. continuous thermal current at B 300	4 A		
	max. making/breaking apparent power at B 300	3600/360 VA		
Mechanical lifetime		30 x 10 ⁶ switching cycles		
Electrical lifetime (AC-12, 230 V, 4 A)		0.1 x 10 ⁶ switching cycles		
Max. fuse rating to achieve short-circuit protection	n/c contact	6 A fast-acting		
	n/o contact	10 A fast-acting		
Conventional thermal current I _{th} (IEC/EN 60947-1)		4 A		
General data				
Duty time		100 %		
Dimensions (W x H x D)	product dimension	22.5 x 85.6 x 103.7 mm (0.89 x 3.37 x 4.08 in)		45 x 85.6 x 103.7 mm (0.89 x 3.37 x 4.08 in)
	packaging dimension	97 x 109 x 30 mm (3.82 x 4.29 x 1.18 in)		97 x 109 x 30 mm (3.82 x 4.29 x 1.18 in)
Weight	net weight	CM-IWS.2P:	CM-IWS.1P:	CM-IWN.xP:
		0.130 kg (0.287 lb)	0.137 kg (0.302 lb)	0.217 kg (0.478 lb)
	CM-IWS.2S:	CM-IWS.1S:	CM-IWN.xS:	
	0.141 kg (0.311 lb)	0.148 kg (0.326 lb)	0.241 kg (0.531 lb)	
gross weight	CM-IWS.2P:	CM-IWS.1P:	CM-IWN.xP:	
	0.155 kg (0.342 lb)	0.162 kg (0.357 lb)	0.246 kg (0.542 lb)	
	CM-IWS.2S:	CM-IWS.1S:	CM-IWN.xS:	
	0.166 kg (0.366 lb)	0.173 kg (0.381 lb)	0.270 kg (0.595 lb)	
Mounting		DIN rail (IEC/EN 60715), snap-on mounting without any tool		
Mounting position		any		
Minimum distance to other units	vertical	not necessary		
	horizontal	10 mm (0.39 in) at U _n > 240 V	not necessary	10 mm (0.39 in) at U _n > 400 V
Material of housing		UL 94 V-0		
Degree of protection	housing / terminal	IP50 / IP20		
Electrical connection				
Wire size	fine-strand with(out) wire end ferrule	Screw connection technology		Easy Connect Technology (Push-in)
		1 x 0.5-2.5 mm ² (1 x 20-14 AWG)	2 x 0.5-1.5 mm ² (2 x 20-16 AWG)	
	rigid	2 x 0.5-1.5 mm ² (2 x 20-16 AWG)	2 x 0.5-1.5 mm ² (2 x 20-16 AWG)	
Stripping length		8 mm (0.32 in)		
Tightening torque		0.6-0.8 Nm (5.31-7.08 lb.in)		
Environmental data				
Ambient temperature ranges	operation / storage / transport	-25...+60 °C/-40...+85 °C/-40...+85 °C		
Climatic category	IEC/EN 60721-3-3	3K5 (no condensation, no ice formation)		
Damp heat, cyclic	IEC/EN 60068-2-30	6 x 24 h cycle, 55 °C, 95 % RH		
Vibration, sinusoidal	IEC/EN 60255-21-1	Class 2		
Shock, half-sine	IEC/EN 60255-21-2	Class 2		

¹⁾ Closed-circuit principle: Output relay(s) de-energize(s) if a fault is occurring
 Open-circuit principle: Output relay(s) energize(s) if a fault is occurring

Insulation monitoring relays for unearthed supply systems

Technical data - CM-IWx

		CM-IWS.2	CM-IWS.1	CM-IWN.1, 4, 5, 6
Isolation data				
Rated impulse withstand voltage U_{imp} between all isolated circuits (IEC/EN 60947-1, IEC/EN 60664-1, VDE 0110-1)	supply / measuring circuit	6 kV		
	supply / output circuit	6 kV		
	measuring / output circuit	6 kV		
	output 1 / output circuit 2			4 kV
Pollution degree (IEC/EN 60664-1, VDE 0110-1)		3		
Overvoltage category (IEC/EN 60664-1, VDE 0110-1)		III		
Rated insulation voltage U (IEC/EN 60947-1, IEC/EN 60664-1, VDE 0110-1)	supply / measuring circuit	400 V	300 V	600 V
	supply / output circuit	300 V		
	supply / measuring circuit	400 V	300 V	600 V
	output 1 / output circuit 2	-	-	300 V
Basis isolation for rated control supply voltage (IEC/EN 60664-1, VDE 0110-1)	supply / measuring circuit	400 V AC / 300 V DC	250 V AC / 300 V DC	400 V AC / 600 V DC
	supply / output circuit	250 V AC / 300 V DC		
	measuring / output circuit	400 V AC / 300 V DC	250 V AC / 300 V DC	400 V AC / 600 V DC
	output 1 / output 2	250 V AC / 300 V DC		
Protective separation (IEC/EN 61140)	supply / output circuit	250 V AC / 250 V DC		
	supply / measuring circuit	250 V AC / 250 V DC		
	measuring / output circuit	250 V AC / 250 V DC		
Test voltage between all isolated circuits, routine test (IEC/EN 60255-5, IEC/EN 61010-1)	supply / output circuit	2.32 kV, 50 Hz, 2 s		
	supply / measuring circuit	2.32 kV, 50 Hz, 2 s		
	measuring / output circuit	2.2 kV, 50 Hz, 1 s		2.53 kV, 50 Hz, 1 s
Standards				
		CM-IWS, CM-IWN.1		CM-IWN.4/5/6
Product standard		IEC/EN 61557-1, IEC/EN 61557-8, IEC/EN 60255-1, EN 50178		IEC/EN 60255-1, EN 50178
Other standards		EN 50178		
Low Voltage Directive		2006/95/EC		
EMC Directive		2004/108/EC		
RoHS Directive		2011/65/EC		
Electromagnetic compability				
Interference immunity to		IEC/EN 61000-6-1, IEC/EN 61000-6-2, IEC/EN 61326-2-4		
electrostatic discharge	IEC/EN 61000-4-2	Level 3, 6 kV / 8 kV		
radiated, radio-frequency, electromagnetic field	IEC/EN 61000-4-3	Level 3, 10 V/m (1 GHz) / 3 V/m (2 GHz) / 1 V/m (2.7 GHz)		
electrical fast transient/burst	IEC/EN 61000-4-4	Level 3, 2 kV / 5 kHz		
surge	IEC/EN 61000-4-5	Level 3, installation class 3, supply circuit and measuring circuit 1 kV L-L, 2 kV L-earth		
conducted disturbances, induced by radio-frequency fields	IEC/EN 61000-4-6	Level 3, 10 V		
voltage dips, short interruptions and voltage variations	IEC/EN 61000-4-11	Class 3		
harmonics and interharmonics	IEC/EN 61000-4-13	Class 3		
Interference emissions		IEC/EN 61000-6-3, IEC/EN 61000-6-4		
high-frequency radiated	IEC/CISPR 22, EN 55022	Class B		
high-frequency conducted	IEC/CISPR 22, EN 55022	Class B		

Insulation monitoring relays for unearthed supply systems

Technical data CM-IVN

2

Input circuit - Measuring circuit		VL+, VL-, V±
Function		expansion of the nominal voltage range of the insulation monitoring relay CM-IWN to 690 V AC or 1000 V DC, max. length of connection cable 40 cm
Measuring principle		see CM-IWN
Nominal voltage U_n of the distribution system to be monitored		0-690 V AC / 0-1000 V DC
Voltage range of the distribution system to be monitored		0-793.5 V AC / 0-1150 V DC (tolerance +15 %)
Rated frequency f_N of the distribution system to be monitored		DC or 15-400 Hz
Tolerance of the rated frequency f_N		13.5-440 Hz
System leakage capacitance C_s	max.	identical to that of the insulation monitoring relay used
Extraneous DC voltage U_{dc} (when connected to an AC system)	max.	793.5 V DC
Tolerance of the adjusted threshold value / Relative percentage uncertainty A at -5...+45 °C, $U_s = 0-115 %$, $U_s = 85-110 %$, $f_N, f_s, C_s = 1 \mu F$	at 1-15 k Ω R_F at 15-200 k Ω R_F	± 1.5 k Ω $\pm 8 %$
Internal impedance Z_i	at 50 Hz	195 k Ω
Internal DC resistance R_i		200 k Ω
Measuring voltage U_m		24 V
Tolerance of measuring voltage U_m		+10 %
Measuring current I_m		0.15 mA
General data		
MTBF		on request
Duty time		100 %
Dimensions (W x H x D)		45 x 78 x 100 mm (1.78 x 3.07 x 3.94 in)
Weight	gross weight	0.200 kg (0.441 lb)
	net weight	0.169 kg (0.373 lb)
Mounting		DIN rail (IEC/EN 60715), snap-on mounting without any tool
Mounting position		any
Minimum distance to other units	vertical	not necessary
	horizontal	10 mm (0.39 in) at $U_n > 600$ V
Degree of protection		IP50 / IP20
Electrical connection		
Wire size	fine-strand with(out) wire end ferrule	2 x 0.75-2.5 mm ² (2 x 18-14 AWG)
	rigid	2 x 0.5-4 mm ² (2 x 20-12 AWG)
Stripping length		7 mm (0.28 in)
Tightening torque		0.6-0.8 Nm (5.31-7.08 lb.in)
Max. length of connection cable to CM-IWN		40 cm
Environmental data		
Ambient temperature ranges	operation / storage / transport	-25...+60 °C / -40...+85 °C / -40...+85 °C
Climatic category	IEC/EN 60721-3-3	3K5 (no condensation, no ice formation)
Damp heat, cyclic	IEC/EN 60068-2-30	6 x 24 h cycle, 55 °C, 95 % RH
Vibration, sinusoidal	IEC/EN 60255-21-1	Class 2
Shock, half-sine	IEC/EN 60255-21-2	Class 2
Isolation data		
Rated impulse withstand voltage U_{imp} between all isolated circuits (IEC/EN 60947-1, IEC/EN 60664-1, VDE 0110-1)	input circuit / PE	8 kV
Pollution degree (IEC/EN 60664-1, VDE 0110-1)		3
Overvoltage category (IEC/EN 60664-1, VDE 0110-1)		III
Rated insulation voltage U_i (IEC/EN 60947-1, IEC/EN 60664-1, VDE 0110-1)	input circuit / PE	1000 V
Test voltage between all isolated circuits, routine test (IEC/EN 60255-5, IEC/EN 61010-1)	input circuit / PE	3.3 kV, 50 Hz, 1 s
Standards		
Product standard		IEC/EN 61557-1, IEC/EN 61557-8, IEC/EN 60255-1, EN 50178
Other standards		EN 50178
Low Voltage Directive		2006/95/EC
EMC Directive		2004/108/EC
RoHS Directive		2011/65/EC
Electromagnetic compability		
Interference immunity to		IEC/EN 61000-6-1, IEC/EN 61000-6-2, IEC/EN 61326-2-4
electrostatic discharge	IEC/EN 61000-4-2	Level 3, 6 kV / 8 kV
radiated, radio-frequency, electromagnetic field	IEC/EN 61000-4-3	Level 3, 10 V/m (1 GHz) / 3 V/m (2 GHz) / 1 V/m (2.7 GHz)
electrical fast transient/burst surge	IEC/EN 61000-4-4 IEC/EN 61000-4-5	Level 3, 2 kV / 5 kHz Level 3, installation class 3, supply circuit and measuring circuit 1 kV L-L, 2 kV L-earth
conducted disturbances, induced by radio-frequency fields	IEC/EN 61000-4-6	Level 3, 10 V
voltage dips, short interruptions and voltage variations	IEC/EN 61000-4-11	Level 3
harmonics and interharmonics	IEC/EN 61000-4-13	Level 3
Interference emission		IEC/EN 61000-6-3, IEC/EN 61000-6-4
high-frequency radiated	IEC/CISPR 22, EN 50022	Class B
high-frequency conducted	IEC/CISPR 22, EN 50022	Class B

Insulation monitoring relays for unearthed supply systems

Notes

Motor load monitoring relays

Product picture

2



Motor load monitoring relays

Table of contents

Motor load monitoring relays

Motor load monitoring relays	124
Fields of application	125
Ordering details	126
Technical information	127
Technical data	128
Benefits and advantages	131
Technical data	132

Motor load monitoring relays

Fields of application

The motor load monitor relay monitors the load states of single-phase and three-phase asynchronous motors. The evaluation of the phase angle between current and voltage allows a very precise monitoring of the load states. Compared with other conventional measuring principles

(e.g. pressure transducers, current measurement), $\cos \varphi$ monitoring is a more precise and economical alternative. The motor is used as a sensor for its own load status.

2

Main applications

- Pump monitoring
 - Dry-running protection (underload)
 - Closed valves (overload)
 - Pipe break (overload)
- Heating, air-conditioning, ventilation
 - Monitoring of filter pollution
 - V-belt breakage (underload)
 - Closed shutters/valves (overload)
 - Air ventilating volume
- Agitating machines
 - High consistency within the tank (overload)
 - Pollution of the tank (overload)
- Transport/Conveyance
 - Congested conveyor belts (overload)
 - Jamming of belts (overload)
 - Material accumulation in spiral conveyors (overload)
 - Lifting platforms
- Machine installation
 - Wear of tools, e.g. worn saw blades in circular saws, etc. (overload)
 - Tool breakage (underload)
 - V-belt drives (breakage underload)

Pump control

Dry-running protection

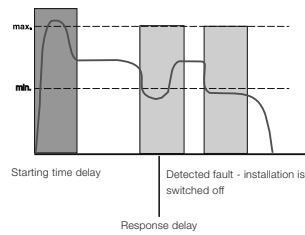

Filter pollution

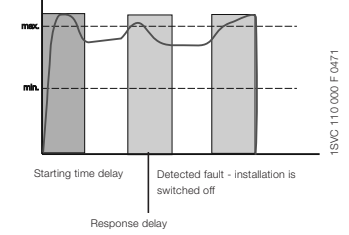

Ventilator monitoring

V-belt monitoring

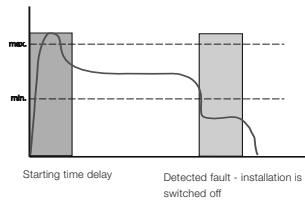

Filter pollution

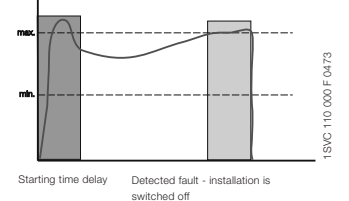

Wiring examples (for motor currents ≤ 20 A)

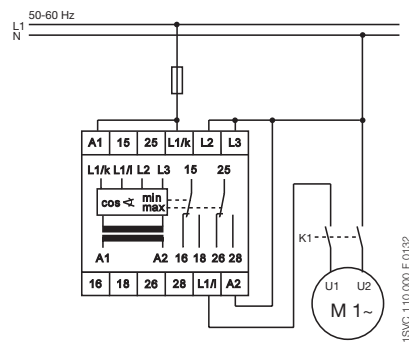
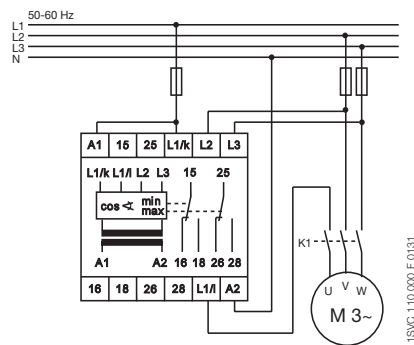

Wiring examples (for motor currents ≥ 20 A)

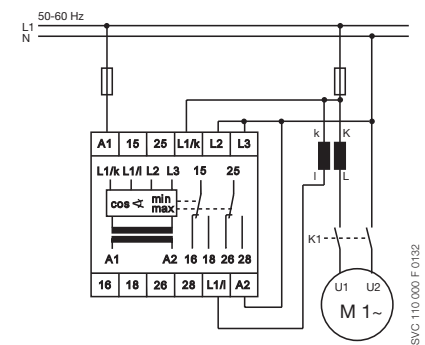
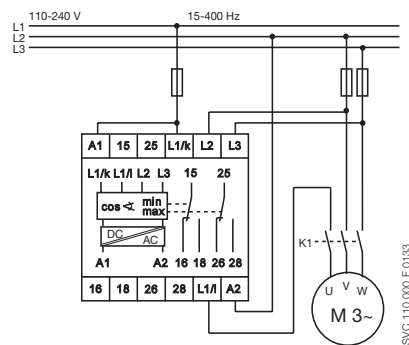
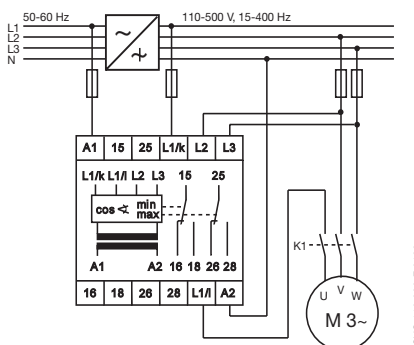
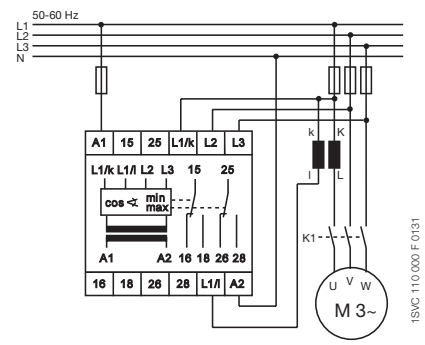

Motor load monitoring relays

Ordering details



CM-LWN

1SVR450335F0100



Further documentation motor load monitoring relays on www.abb.com

Description

The CM-LWN monitors the motor load of single-phase and three-phase asynchronous motors. The evaluation of the phase angle between current and voltage ($\cos \varphi$ monitoring) allows a very precise monitoring of the motor load status.

Ordering details

Rated control supply voltage	Current range	Type	Order code	Price	Weight (1 pce)
				1 pce	kg (lb)
24-240 V AC/DC	0.5-5 A	CM-LWN	1SVR450335R0000		0.30 (0.66)
110-130 V AC			1SVR450330R0000		0.30 (0.66)
220-240 V AC			1SVR450331R0000		0.30 (0.66)
380-440 V AC			1SVR450332R0000		0.30 (0.66)
480-500 V AC			1SVR450334R0000		0.30 (0.66)
24-240 V AC/DC	2-20 A		1SVR450335R0100		0.30 (0.66)
110-130 V AC			1SVR450330R0100		0.30 (0.66)
220-240 V AC			1SVR450331R0100		0.30 (0.66)
380-440 V AC			1SVR450332R0100		0.30 (0.66)
480-500 V AC			1SVR450334R0100		0.30 (0.66)

Current transformers "Ordering details - CM-CT current transformers" on page 177"

Characteristics

- Pump monitoring
- Under- and overload monitoring $\cos \varphi$ in one unit
- Adjustable starting delay 0.3-30 s
- Direct measurement of currents up to 20 A
- Adjustable response time delay 0.2-2 s
- Single-phase or three-phase monitoring
- 2 x 1 c/o contact, closed-circuit principle
- 3 LEDs for status indication



2CDC 253 010 F0013

- Starting delay „Time S“
- Response delay „Time R“
- Threshold for load limit $\cos \varphi_{\max}$
- Threshold for load limit $\cos \varphi_{\min}$
- Reset button
- Indication of operational states
 U: green LED – control supply voltage
 $\cos \varphi_{\max}$: red LED – $\cos \varphi_{\max}$ exceeded
 $\cos \varphi_{\min}$: red LED – below $\cos \varphi_{\min}$
- Marker label

Motor load monitoring relays

Technical information

The CM-LWN module monitors the load status of inductive loads.

The primary application is the monitoring of single- or three-phase asynchronous motors (squirrel cage) under varying load conditions. The measuring principle is based on the evaluation of the phase shift (φ) between the voltage and the current in one phase.

2

The phase difference is nearly inversely proportional to the load. Therefore, $\cos \varphi$, measured relatively from 0 to 1, measures the relationship of effective power to apparent power. A value towards 0 indicates low load and a value towards 1 indicates high load.

Threshold values can be set individually for $\cos \varphi_{\max}$ and $\cos \varphi_{\min}$. If the set threshold value is reached, a LED lights up and the relay is de-energized.

If $\cos \varphi$ returns to the acceptable limits (taking into account the hysteresis), the relay is reset to its original state and the LED flashes permanently to indicate the occurrence of the trip event. This message can be deleted using the reset button or by switching off the supply.

A time delay (Time S) of 0.3 to 30 s can be set for the starting phase of the motor. It is also possible to set a response delay time (Time R) of 0.2 to 2 s to suppress unwanted tripping due to unavoidable short load changes during normal operation.

To guarantee correct operation of the response delay (Time R), the adjusted value for $\cos \varphi_{\max}$ has to be higher than the value for $\cos \varphi_{\min}$ plus the hysteresis. Consequently, the overload and underload indication must not be active at the same time.

Due to the internal electrical isolation of the supply circuit and the measuring circuit, it is also possible to use the device in systems with different supply voltages.

Function diagram - CM-LWN

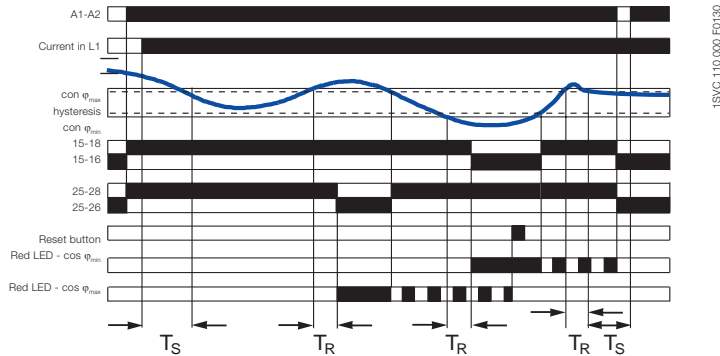

Connection diagram CM-LWN

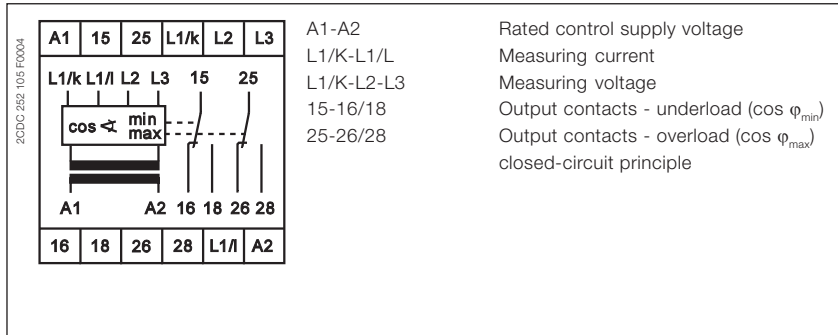

Motor load monitoring relays

Technical data

Type		CM-LWN A1-A2
Input circuit - Supply circuit		
Rated control supply voltage U_s - power consumption	A1-A2	24-240 V AC/DC approx. 8.4 VA/W
	A1-A2	110-130 V AC approx. 3.6 VA
	A1-A2	220-240 V AC approx. 3.6 VA
	A1-A2	380-440 V AC approx. 3.6 VA
	A1-A2	480-500 V AC approx. 3.6 VA
Rated control supply voltage U_s tolerance		-15 %...+10 %
Rated frequency	AC versions	50-60 Hz
	AC/DC versions	15-400 Hz or DC
Duty time		100 %
Measuring circuit		L1/L-L1/K-L2-L3
Monitoring function		Motor load monitoring by $\cos \varphi$
Voltage range	L1/K-L2-L3	110-500 V AC single-phase or three-phase
Current range	L1/L-L1/K	0.5-5 A version 2-20 A version
Permissible overload of current input		25 A for 3 s 100 A for 3 s
Thresholds		$\cos \varphi_{\min}$ and $\cos \varphi_{\max}$ adjustable from 0 to 1
Hysteresis (related to phase angle φ in °)		4°
Frequency of measuring voltage		15-400 Hz
Response time		300 ms
Timing circuits		indication of over- and undervoltage fault
Start-up time (Time S)		0.3-30 s, adjustable
Response delay (Time R)		0.2-2 s, adjustable
Accuracy within the rated control supply voltage tolerance		$\Delta t \leq 0.5 \%$
Accuracy within the temperature range		$\Delta t \leq 0.06 \%$ / °C
Indication of operational states		
Control supply voltage		U: green LED
below $\cos \varphi_{\min}$		$\cos \varphi_{\min}$: red LED
$\cos \varphi_{\max}$ exceeded		$\cos \varphi_{\max}$: red LED
Output circuits		15-16/18, 25-26/28
Kind of output		2 x 1 c/o contact
Operational principle		closed-circuit principle ¹⁾
Contact material		AgCdO
Rated voltage (VDE 0110, IEC 664-1, IEC 947-1)		250 V
Max. switching voltage		400 V AC, 300 V DC
Rated operational current I_o (IEC/EN 60947-1)	AC-12 (resistive) 230 V	4 A
	AC-15 (inductive) 230 V	3 A
	DC-12 (resistive) 24 V	4 A
	DC-13 (inductive) 24 V	2 A
AC rating (UL 508)	Utilization category (Control Circuit Rating Code)	B 300
	max. rated operational voltage	300 V AC
	max. continuous thermal current at B 300	5 A
	max. making/breaking apparent power at B 300	3600/360 VA
Mechanical lifetime		30 x 10 ⁶ switching cycles
Electrical lifetime	at AC-12, 230 V, 4 A	0.1 x 10 ⁶ switching cycles
Max. fuse rating to achieve short-circuit protection	n/c / n/o contact	10 A fast-acting / 10 A fast-acting
General data		
Dimensions (W x H x D)		45 mm x 78 mm x 100 mm (1.77 inch x 3.07 inch x 3.94 inch)
Mounting position		any
Degree of protection	housing / terminals	IP50 / IP20
Ambient temperature range	operation / storage	-25...+65 °C / -40...+85 °C
Mounting		DIN rail (IEC/EN 60715)
Electrical connection		
Wire size	fine-strand with wire end ferrule	2 x 2.5 mm ² (2 x 14 AWG)
Standards		
Product standard		IEC 255-6, EN 60255-6
Low Voltage Directive		2006/95/EC
EMC Directive		2004/108/EC, 91/263/EEC, 92/31/EEC, 93/68/EEC, 93/67/EEC
Electromagnetic compatibility		EN 61000-6-2, EN 61000-6-4
electrostatic discharge	IEC/EN 61000-4-2	Level 3 (6 kV / 8 kV)
radiated, radio-frequency, electromagnetic field	IEC/EN 61000-4-3	Level 3 (10 V/m)
electrical fast transient / burst	IEC/EN 61000-4-4	Level 3 (2 kV / 5 kHz)
surge	IEC/EN 61000-4-5	Level 4 (2 kV L-L)
conducted disturbances, induced by radio-frequency fields	IEC/EN 61000-4-6	Level 3 (10 V)
Operational reliability (IEC 68-2-6)		5 g
Mechanical resistance (IEC 68-2-6)		10 g
Environmental testing (IEC 68-2-30)		24 h cycle time, 55 °C, 93 % rel., 96 h
Isolation data		
Rating (HD 625.1 S1, VDE 0110, IEC 664-1, IEC 60255-5)		
Rated insulation voltage between supply-, measuring- and output circuit		250 V, 400 V, 500 V depending on the version
Rated impulse withstand voltage between all isolated circuits		4 kV / 1.2 - 50 μs
Test voltage between all isolated circuits		2.5 kV, 50 Hz, 1 min.
Pollution category		3
Overvoltage category		III

¹⁾ Open-circuit principle: Output relay is energized if the measured value exceeds/drops below the adjusted threshold.
Closed-circuit principle: Output relay is de-energized if the measured value exceeds/drops below the adjusted threshold.

Motor control and protection

Product group picture

2



Motor control and protection

Table of contents

Motor control and protection

Benefits and advantages	131
Technical data	132

Motor control and protection

Benefits and advantages

2

UMC100.3 is a flexible, modular and expandable motor management system for constant-speed low-voltage range motors. Its most important tasks include motor protection, prevention of plant standstills and the reduction of down time. This is made possible by early information relating to possible motor problems which avoids unplanned plant standstills. Even if a motor trips, quick diagnosis of the cause of the fault serves to reduce downtime.

UMC100.3 combines in a very compact unit:

Motor protection

- Overload, underload
- Overvoltage, undervoltage
- Blocked rotor, low / high current
- Phase failure, imbalance, phase sequence
- Earth leakage
- Thermistor protection
- Limitation of starts per time
- One single version with integrated measuring system covers the rated motor current from 0.24 to 63 A

Motor control

- Integrated and easy to parametrize motor starter functions like direct, reverse, star-delta,...
- Additionally free programmable logic for application specific control functions
- Expansion modules DX111, DX122 for more I/Os
- Expansion modules VI150, VI155 for 3-phase voltage measuring
- Analog and temperature module AI111

Motor diagnostics

- Quick and comprehensive access to all relevant data via fieldbus and/or operator panel
- Current, thermal load
- Phase voltages
- Power factor
- Energy

Communication

- Communication-independent basic device
- Freely selectable fieldbus protocol with FieldBusPlug
- Profibus DP
- DeviceNet
- Modbus RTU
- Ethernet Modbus TCP
- Profinet

Typical application segments

- Oil & gas
- Cement
- Paper
- Mining
- Steel
- Chemical industry

Further information

UMC Catalog 2CDC 190 022 C0206

UMC Brochure 2CDC 135 011 B0203

Motor control and protection

Technical data

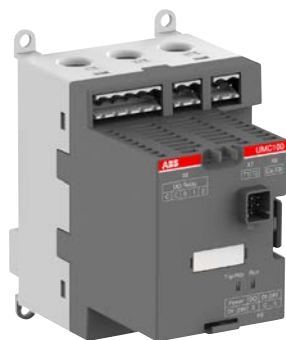

Basic device UMC100.3

Main power

Voltage	max 1000 V AC
Frequency	45...65 Hz
Rated motor current	0.24...63 A, without accessories Higher currents with external transformer
Tripping classes	5E, 10E, 20E, 30E, 40E in accordance with EN/IEC 60947-4-1
Short-circuit protection	Separate fuse on network side

Control unit

Supply voltage	24 V DC, 110-240 V AC/DC
Inputs	6 digital inputs 24 V DC 1 PTC input
Outputs	3 digital relay outputs 1 digital transistor output

Expansion modules

The UMC100.3 can be expanded with maximum 4 expansion modules: One digital expansion module DX111 or DX122, one module VI150 or VI155 and 2 analog modules AI111. Communication takes place via a simple two-wire line. The maximum distance allowed between the UMC100.3 and the expansion module is 3 m.



Digital expansion modules DX111 / DX122

Expands the UMC100.3 to include additional digital inputs and outputs and an analog output

Supply voltage	24 V DC
Inputs	DX111: 8 digital inputs 24 V DC DX122 8 digital inputs 110/230 V AC
Outputs	4 digital relay outputs 1 analog output, 0/4...20 mA, / 0...10 V configurable

Voltage modules VI150/VI155

Voltage modules for determining phase voltages, power factor (cos ϕ), active power, apparent power, energy, harmonic content (THD)

VI150 for use in grounded networks

VI155 for use in grounded and ungrounded networks

Supply voltage	24 V DC
Voltage inputs	L1, L2, L3
Rated voltage range	150 ... 690 V AC
Outputs	1 digital relay output



Analog module AI111

Expand the UMC100.3 with analog and temperature inputs

Supply voltage	24 V DC
Inputs	0-10 V, 0/4-20 mA PT100, PT1000, 2- or 3-wire connection KTY83, KTY84, NTC

Motor control and protection

Technical data

2



Ethernet communication interfaces

Mounted in the MCC cable chamber; connection of 1 to 4 motor controllers UMC100.3 via simple cables

MTQ22	for Modbus TCP
PNQ22	for Profinet IO



Fieldbus communication interfaces

Can be mounted direct on the UMC100.3 or separate in the cable chamber of the MCC. Connection for standard fieldbus cables with 9-pole Sub-D (Profibus DP) or terminal blocks

PDP32	for Profibus DP
DNP31	for DeviceNet
MRP31	for Modbus RTU



CEM11 earth leakage sensors

Summation current transformer for connecting to a digital input
Mounting with bracket on DIN busbar or wall
Models

CEM11-FBP.20	80 – 1.700 mA	20 mm Ø
CEM11-FBP.35	100 – 3.400 mA	35 mm Ø
CEM11-FBP.60	120 – 6.800 mA	60 mm Ø
CEM11-FBP.120	300 – 13.600 mA	120 mm Ø

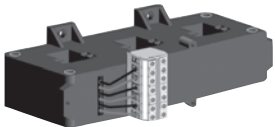

Current transformer CT4L / CT5L

Only required for rated motor currents >63 A
Linear transformer, 3-phase with terminal block, designed for connecting leads Cu 2.5 mm²



UMC100-PAN control panel

Installation on the device or on the switching cabinet door
Graphics-enabled and backlit display, 3 LEDs for status indication
Freely configurable error messages
USB port for PC connection
Multilingual: German, English, French, Italian, Polish, Portuguese, Spanish, Russian

Motor control and protection

Notes

Thermistor motor protection relays

Product group picture

2

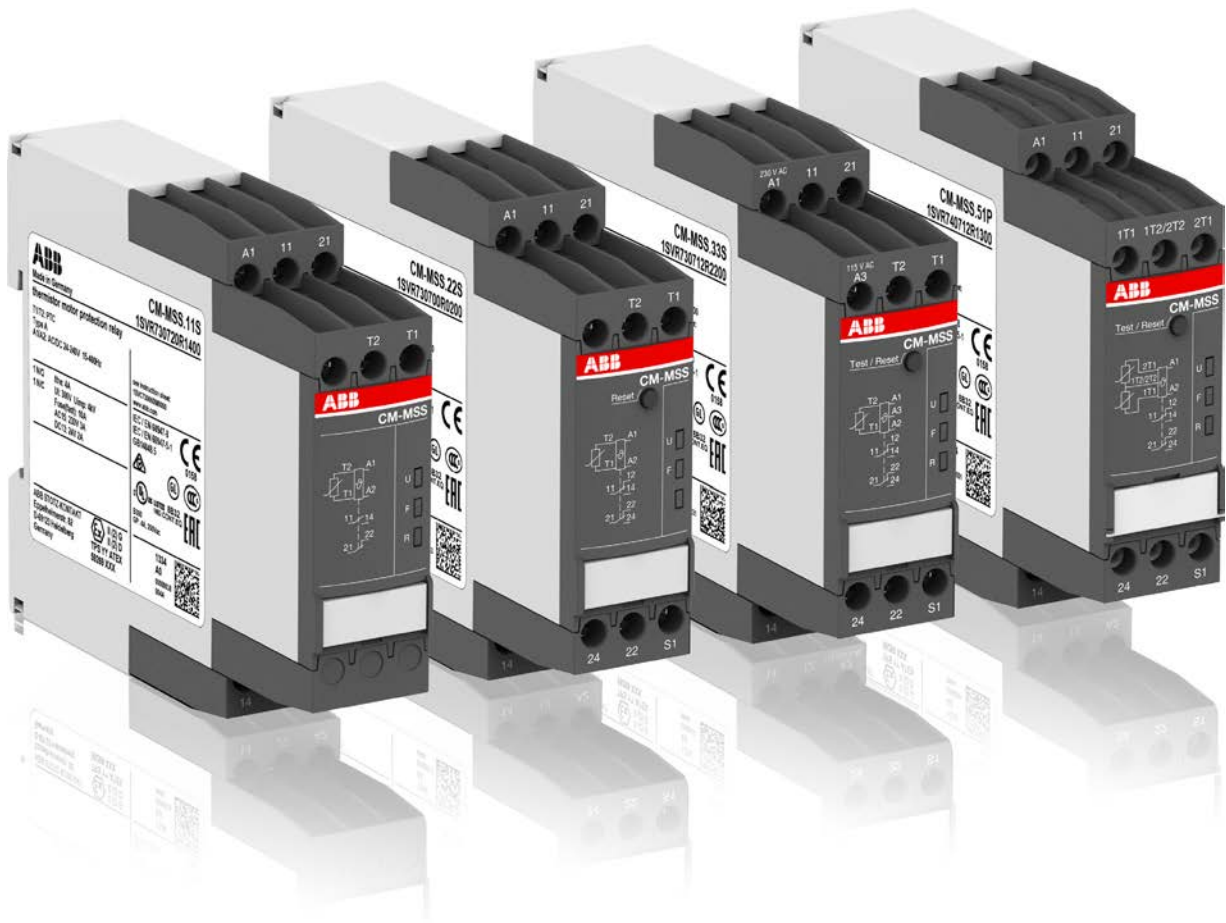

Thermistor motor protection relays

Table of contents

Thermistor motor protection relays

Thermistor motor protection relays	136
Benefits and advantages, Applications	137
Operating controls	138
Selection table CM-MSx range	139
Ordering details	140
Ordering details - PTC temperature sensors C011	141
Technical data - CM-MSS	142
Technical data - CM-MSE	145
Connection diagrams	147
Circuit diagram	148

Thermistor motor protection relays

Benefits and advantages, Applications

The thermistor motor protection relays of the CM-MSx range protect motors with PTC sensors against high temperature. These sensors are incorporated in the motor windings thus measuring the motor heat directly.

2

Direct temperature measuring

Generally, motor damages caused by overload or overheating situations can be prevented in different ways. Compared to the indirect temperature measuring which monitors the motor current, the temperature inside the motor can be measured by direct temperature measuring.

This enables direct control and evaluation of the following operating conditions like:

- Heavy duty starting
- Increased switching frequency
- Single phase operation
- Phase unbalance
- High ambient temperature
- Insufficient cooling
- Breaking operation

Therefore the consequences from overheating like abrasion as well as electrical failures can be prevented.

The direct measuring principle is carried out by a combination of the thermistor motor protection relay and 3 PTC sensors which are installed directly in the motor by the manufacturer. Those 3 PTC sensors are placed directly at the thermal hotspots, the motor windings.

Characteristics CM-MSS¹⁾

- Different types of contacts available
 - 1 x 2 c/o (SPDT) contacts
 - 2 x 1 c/o (SPDT) contact
 - 1 n/o and 1 n/c contact
- 1 or 2 measuring circuits
- Different types of reset functions
 - Automatic
 - Manual
 - Remote
- Rated control supply voltages
 - 24 V AC/DC
 - 24-240 V AC/DC
 - 110-130 V AC, 220-240 V AC
- Approvals / Marks



Monitoring the motor

The thermistor motor protection relay measures the resistance of the PTC sensors which reflects the internal motor temperature permanently.

If the temperature in the motor windings rises excessively and reaches the nominal response temperature (NRT), the thermistor motor protection relay detects this situation and the output relay switches off.

By doing so the motor contactor gets triggered and switches off the motor.

CM-MSS functionality video



Features ¹⁾

- Additional functions:
 - Dynamic interrupted wire detection
 - Short-circuit monitoring of the sensor circuit
 - Non-volatile fault storage
 - Single or sum evaluation
- Easy configuration via DIP switches
- LEDs to distinguish between different failure causes
- Screw connection technology or Easy Connect Technology available
- Test/Reset button available

¹⁾ Depending on device the characteristics vary, for detailed overview see "Selection table CM-MSx range" on page 139.

Characteristics CM-MSE

- Auto reset
- Connection of several sensors (max. 6 sensors connected in series)
- Monitoring of bimetals
- 1 n/o contact
- Excellent cost / performance ratio

Thermistor motor protection relays

Operating controls

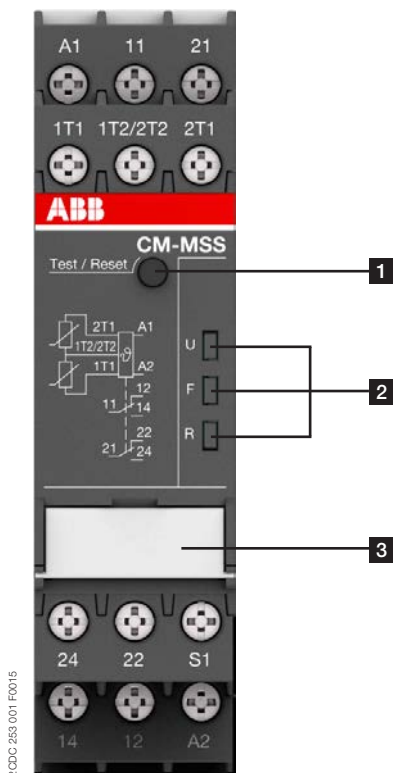

- 1 Test / Reset button**
Reset - only possible if measured value < switch-on resistance

- 2 Indication of operational states with LEDs**
 U: green LED - Status indication of control supply voltage
 Control supply voltage applied
 F: red LED - Fault message
 R: yellow LED - Status indication of the output relay

- 3 Marker label / DIP switches (depending on device) e.g.**
 - Single evaluation 2 x 1 c/o (SPDT) contact
 - Accumulative evaluation 1 x 2 c/o (SPDT) contacts
 - Short-circuit detection de-activated
 - Short-circuit detection activated
 - Non-volatile fault storage activated
 - Non-volatile fault storage de-activated
 - Remote Reset
 - Remote Test/Reset

LEDs, status information and fault messages CM-MSS

Operational state	U: green LED	F: red LED	R: yellow LED
Absence of control supply voltage	OFF	OFF	OFF
Internal fault ²⁾	OFF		
Internal fault ²⁾			
Control supply voltage not within the tolerance range			OFF
Short circuit			OFF
Interrupted wire			OFF
Measuring circuit 2: Overtemperature			OFF
Measuring circuit 1: Overtemperature			OFF
Fault rectified but not confirmed		-- ¹⁾	
Test function		OFF	OFF
Change of configuration not confirmed		OFF	
No fault		OFF	

¹⁾ Depending on the fault with the highest priority
²⁾ Restart the device. If after restart the same fault is indicated, replace the device.

Thermistor motor protection relays

Selection table CM-MSx range

2

Type	Order code																						
CM-MSE	1SVR550805R9300																						
CM-MSE	1SVR550800R9300																						
CM-MSE	1SVR550801R9300																						
CM-MSS.11P	1SVR740720R1400																						
CM-MSS.11S	1SVR730720R1400																						
CM-MSS.12P	1SVR740700R0100																						
CM-MSS.12S	1SVR730700R0100																						
CM-MSS.13P	1SVR740700R2100																						
CM-MSS.13S	1SVR730700R2100																						
CM-MSS.21P	1SVR740722R1400																						
CM-MSS.21S	1SVR730722R1400																						
CM-MSS.22P	1SVR740700R0200																						
CM-MSS.22S	1SVR730700R0200																						
CM-MSS.23P	1SVR740700R2200																						
CM-MSS.23S	1SVR730700R2200																						
CM-MSS.31P	1SVR740712R1400																						
CM-MSS.31S	1SVR730712R1400																						
CM-MSS.32P	1SVR740712R0200																						
CM-MSS.32S	1SVR730712R0200																						
CM-MSS.33P	1SVR740712R2200																						
CM-MSS.33S	1SVR730712R2200																						
CM-MSS.41P	1SVR740712R1200																						
CM-MSS.41S	1SVR730712R1200																						
CM-MSS.51P	1SVR740712R1300																						
CM-MSS.51S	1SVR730712R1300																						
ATEX approval																							
Number of sensor circuits	1	1	1	1	1	1	1	1	1	1	1	1	1	1	1	1	1	1	1	1	1	1	
Single or accumulative evaluation																							
Number of LEDs				3	3	2	2	2	2	3	3	2	2	2	2	3	3	3	3	3	3	3	
1 c/o (SPDT) contact																							
2 c/o (SPDT) contacts																							
1 n/o																							
1 n/c and 1 n/o																							
2 x 1 c/o or 1 x 2 c/o contacts, configurable																							
Manual																							
Remote																							
Auto																							
Test button																							
Short-circuit detection																							
Short-circuit detection, configurable																							
Dynamic interrupted wire detection																							
Non-volatile fault storage																							
Non-volatile fault storage, configurable																							
24 V AC																							
110-130 V AC																							
220-240 V AC																							
24-240 V AC/DC																							
24 V AC/DC																							
110-130 V AC, 220-240 V AC																							
Push-in terminals																							
Double-chamber cage connection terminals																							

¹⁾ For automatic reset, connect terminals S1 to T2.
²⁾ For automatic reset, connect Terminals S1 to 1T2/2T2.

Thermistor motor protection relays

Ordering details



CM-MSS.12S

2CDC 251 004 V0014



CM-MSS.41S

2CDC 251 013 V0014



CM-MSS.51S

2CDC 251 014 V0014

Description

The thermistor motor protection relay CM-MSS monitors the winding temperature and thus protects the motor from overheating, overload and insufficient cooling in accordance to the product standard IEC 60947-8.

Ordering details CM-MSx

Characteristics	Type	Order code	Price	Weight
			1 pce	(1 pce)
				kg (lb)
	CM-MSE	1SVR550805R9300		0.11 (0.24)
	CM-MSE	1SVR550800R9300		0.11 (0.24)
	CM-MSE	1SVR550801R9300		0.11 (0.24)
	CM-MSS.11P	1SVR740720R1400		0.119 (0.263)
	CM-MSS.11S	1SVR730720R1400		0.127 (0.280)
	CM-MSS.12P	1SVR740700R0100		0.105 (0.231)
	CM-MSS.12S	1SVR730700R0100		0.113 (0.249)
	CM-MSS.13P	1SVR740700R2100		0.147 (0.324)
	CM-MSS.13S	1SVR730700R2100		0.155 (0.342)
	CM-MSS.21P	1SVR740722R1400		0.118 (0.260)
	CM-MSS.21S	1SVR730722R1400		0.126 (0.278)
	CM-MSS.22P	1SVR740700R0200		0.121 (0.267)
	CM-MSS.22S	1SVR730700R0200		0.132 (0.291)
	CM-MSS.23P	1SVR740700R2200		0.163 (0.359)
	CM-MSS.23S	1SVR730700R2200		0.174 (0.384)
	CM-MSS.31P	1SVR740712R1400		0.120 (0.265)
	CM-MSS.31S	1SVR730712R1400		0.128 (0.282)
	CM-MSS.32P	1SVR740712R0200		0.120 (0.265)
	CM-MSS.32S	1SVR730712R0200		0.130 (0.287)
	CM-MSS.33P	1SVR740712R2200		0.162 (0.357)
	CM-MSS.33S	1SVR730712R2200		0.172 (0.379)
	CM-MSS.41P	1SVR740712R1200		0.130 (0.287)
	CM-MSS.41S	1SVR730712R1200		0.141 (0.311)
	CM-MSS.51P	1SVR740712R1300		0.135 (0.298)
	CM-MSS.51S	1SVR730712R1300		0.145 (0.320)

See "Selection table CM-MSx range" on page 139.

S: screw connection
P: push-in connection



Further documentation thermistor motor protection monitoring relays on www.abb.com

Thermistor motor protection relays

Ordering details - PTC temperature sensors C011

2



1SWC 110 000 F0531

Temperature sensor characteristics

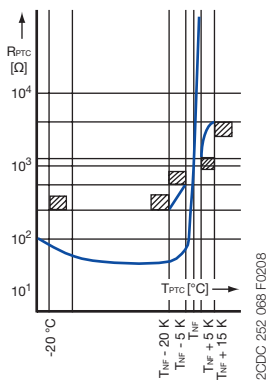

¹⁾ Temperature sensor C011, standard version acc. to DIN 44081

²⁾ Triple temperature sensor C011-3

Description

The PTC temperature sensors (temperature-dependent with positive temperature coefficient) are selected by the manufacturer of the motor depending on:

- the motor insulation class according to IEC/EN 60034-11,
- the special characteristics of the motor, such as the conductor cross-section of the windings, the permissible overload factor etc.
- special conditions prescribed by the user, such as the permissible ambient temperature, risks resulting from locked rotor, extent of permitted overload etc.

One temperature sensor must be embedded in each phase winding. For instance, in case of three-phase squirrel cage motors, three sensors are embedded in the stator windings. For pole-changing motors with one winding (Dahlander connection), 3 sensors are also sufficient. Pole-changing motors with two windings, however, require The sensors are suitable for embedding in motor windings with rated operating voltages of up to 600 V AC. Conductor length: 500 mm per sensor. A 14 V varistor can be connected in parallel to protect the sensors from overvoltage. Due to their characteristics, the thermistor motor protection relays can also be used with PTC temperature sensors of other manufacturers which comply with DIN 44 081 and DIN 44 082 6 sensors.

If an additional warning is required before the motor is switched off, separate sensors for a correspondingly lower temperature must be embedded in the winding. They have to be connected to a second control unit.

Ordering details CM-MSS accessories

Rated response temperature T_{NF}	Color coding	Type	Order code	Price 1 pce	Weight (1 pce) kg (lb)
70 °C	white-brown	C011-70 ¹⁾	GHC0110003R0001		0.02 (0.044)
80 °C	white-white	C011-80 ¹⁾	GHC0110003R0002		0.02 (0.044)
90 °C	green-green	C011-90 ¹⁾	GHC0110003R0003		0.02 (0.044)
100 °C	red-red	C011-100 ¹⁾	GHC0110003R0004		0.02 (0.044)
110 °C	brown-brown	C011-110 ¹⁾	GHC0110003R0005		0.02 (0.044)
120 °C	gray-gray	C011-120 ¹⁾	GHC0110003R0006		0.02 (0.044)
130 °C	blue-blue	C011-130 ¹⁾	GHC0110003R0007		0.02 (0.044)
140 °C	white-blue	C011-140 ¹⁾	GHC0110003R0011		0.02 (0.044)
150 °C	black-black	C011-150 ¹⁾	GHC0110003R0008		0.02 (0.044)
160 °C	blue-red	C011-160 ¹⁾	GHC0110003R0009		0.02 (0.044)
170 °C	white-green	C011-170 ¹⁾	GHC0110003R0010		0.02 (0.044)
150 °C	black-black	C011-3-150 ²⁾	GHC0110033R0008		0.05 (0.11)

¹⁾ Temperature sensor C011, standard version acc. to DIN 44081

²⁾ Triple temperature sensor C011-3

Technical data

Characteristic data	Sensor type C011
Cold-state resistance	50 -100 Ω at 25 °C
Warm-state resistance ± 5 up to 6 K of rated response temperature T_{NF}	10 000 Ω
Thermal time constant, sensor open ¹⁾	< 5 s
Permitted ambient temperature	+180 °C

Rated response temperature ± tolerance $T_{NF} \pm \Delta T_{NF}$	PTC resistance R from -20 °C to T_{NF} - 20 K	PTC resistance R2) at PTC temperatures of:			
		$T_{NF} - \Delta T_{NF}$ (UPTC ≤ 2.5 V)	$T_{NF} + \Delta T_{NF}$ (UPTC ≤ 2.5 V)	$T_{NF} + 15 K$ (UPTC ≤ 7.5 V)	
70 ± 5 °C	≤ 100 Ω	≤ 570 Ω	≥ 570 Ω	-	
80 ± 5 °C					
90 ± 5 °C					
100 ± 5 °C					
110 ± 5 °C					
120 ± 5 °C					
130 ± 5 °C			≤ 550 Ω	≥ 1330 Ω	≥ 4000 Ω
140 ± 5 °C					
150 ± 5 °C					
160 ± 5 °C					
170 ± 7 °C		≤ 570 Ω	≥ 570 Ω	-	

¹⁾ Not embedded in windings.

²⁾ For triple temperature sensor take values x 3.

Thermistor motor protection relays

Technical data - CM-MSS

Technical data

Data at $T_a = 25\text{ °C}$ and rated values, unless otherwise indicated

Supply circuit - Input circuit		CM-MSS.x1	CM-MSS.x2	CM-MSS.x3
Rated control supply voltage U_s	A1-A2	24-240 V AC/DC	24 V AC/DC	220-240 V AC
	A2-A3	-	-	110-130 V AC
Rated control supply voltage U_s tolerance		-15...+10 %		
Rated frequency		15-400 Hz	50-60 Hz	
Electrical insulation between supply circuit and measuring circuit		yes	no	yes
Power failure buffering time		20 ms		
Supply circuit - Measuring circuit / Sensor circuit				
Number of circuits		1 (CM-MSS.51: 2)		
Sensor type		PTC type A (DIN/EN 44081, DIN/EN 44082)		
Max. total resistance of sensors connected in series, cold state		< 750 Ω		
Overtemperature monitoring	switch-off resistance (relay de-energizes)	2.83 k Ω \pm 1% (CM-MSS.12 /13 /22 /23: 2.7 k Ω \pm 5%)		
	switch-on resistance (relay energizes)	1.1 k Ω \pm 1% (CM-MSS.12 /13 /22 /23: 1.2 k Ω \pm 5%)		
Maximum voltage in sensor circuit	1.33 k Ω	2.5 V		
	4 k Ω	3.7 V		
	∞ k Ω	5.5 V		
Maximum current in sensor circuit		3.7 mA		
Maximum sensor cable length		2 x 100 m at 0.75 mm ² , 2 x 400 m at 2.5 mm ²		
Accuracy within the rated control supply voltage tolerance		0.50 % (CM-MSS.12 /13 /22 /23: 5 %)		
Accuracy within the temperature range		0.01 %/K (CM-MSS.12 /13 /22 /23: 0.5 %/K)		
Repeat accuracy (constant parameters)		on request		
Reaction time of the safety function		< 100 ms		
Hardware fault tolerance (HFT)		0		
Control circuit				
Control function		see "Selection table CM-MSx range" on page 139		
Maximum no-load voltage		5.5 V		
Max. current		0.6 mA (CM-MSS.12 /13 /22 /23: 1.2 mA)		
Maximum cable length		2 x 100 m at 0.75 mm ² , 2 x 400 m at 2.5 mm ²		
Indication of operational states				
Control supply voltage	U	LED green		
Relay status	R	LED yellow		
Fault message	F	LED red		
Output circuit				
Kind of output		see "Selection table CM-MSx range" on page 139		
Operating principle		closed-circuit principle		
Contact material		AgNi alloy, Cd free		
Rated operational voltage U_e (IEC/EN 60947-1)		250 V AC		
Minimum switching voltage / Minimum switching current		24 V / 10 mA		
Maximum switching voltage / Maximum switching current		see data sheet		
Rated operating current I_e (IEC/EN 60947-5-1)	AC-12 (resistive) at 230 V	4 A		
	AC-15 (inductive) at 230 V	3 A		
	DC-12 (resistive) at 24 V	4 A		
	DC-13 (inductive) at 24 V	2 A		
AC Rating (UL 508)	utilization category (Control Circuit Rating Code)	B 300		
	maximum rated operational voltage	300 V AC		
	maximum continuous thermal current at B 300	5 A		
	maximum making/breaking apparent power at B 300	3600/360 VA		
	general purpose rating	250 V AC - 4 A		
Mechanical lifetime		30 x 10 ⁶ switching cycles		
Electrical lifetime	at AC12, 230 V AC, 4 A	0.1 x 10 ⁶ switching cycles		
Maximum fuse rating to achieve short-circuit protection	n/c contact	10 A fast-acting (CM-MSS.12, CM-MSS.13, CM-MSS.51: 6 A)		
	n/o contact	10 A fast-acting		

Thermistor motor protection relays

Technical data - CM-MSS

2

General data		
MTBF		on request
Duty time		100 %
Dimensions (W x H x D)	product dimensions	22.5 x 85.6 x 103.7 mm (0.89 x 3.37 x 4.08 in)
	packaging dimensions	97 x 109 x 30 mm (3.82 x 4.29 x 1.18 in)
Weight		see "Ordering details" on page 140
Mounting		DIN rail (IEC/EN 60715), snap-on mounting without any tool
Mounting position		any
Minimum distance to other units	vertical	10 mm (0.394 in) if switching current > 2 A
	horizontal	10 mm (0.394 in) if switching current > 2 A
Material of housing		UL 94 V-0
Degree of protection	housing	IP50
	terminals	IP20
Electrical connection		Screw connection technology
Connection capacity	fine-strand with(out) wire end ferrule	Easy Connect Technology (push-in)
	rigid	
Stripping length		8 mm (0.32 in)
Tightening torque		0.6-0.8 Nm (7.08 lb.in)
Wire end ferrule		according to DIN 46228-1-A, DIN 46228-4-E
Environmental data		
Ambient temperature ranges	operation	-25...+60 °C (-13...+140 °F)
	storage	-40...+85 °C (-40...+185 °F)
Damp heat, cyclic (IEC/EN 60068-2-30)		6 x 24 h cycle, 55 °C, 95 % RH
Climatic class (IEC/EN 60721-3-3)		3K5 (no condensation, no ice formation)
Vibration, sinusoidal (IEC/EN 60255-21-1)		Class 2
Shock (IEC/EN 60255-21-2)		Class 2
Isolation data		
Rated insulation voltage U _i (IEC/EN 60947-1, IEC/EN 60664-1)	Supply circuit / Measuring circuit ¹⁾	300 V AC (CM-MSS.x2: n/a)
	Supply circuit / Output circuits	300 V AC
	Measuring circuit ¹⁾ / Output circuits	300 V AC
	Output circuit 1 / Output circuit 2	300 V AC
Rated impulse withstand voltage U _{imp} (IEC/EN 60947-1, IEC/EN 60664-1)	Supply circuit / Measuring circuit ¹⁾	4 kV / 6 kV (CM-MSS.x2: n/a)
	Supply circuit / Output circuits	4 kV / 6 kV
	Measuring circuit ¹⁾ / Output circuits	4 kV / 6 kV
	Output circuit 1 / Output circuit 2	4 kV
Basic insulation (IEC/EN 60664-1)	Supply circuit / Measuring circuit ¹⁾	600 V AC (CM-MSS.x2: n/a)
	Supply circuit / Output circuits	600 V AC
	Measuring circuit ¹⁾ / Output circuits	600 V AC
	Output circuit 1 / Output circuit 2	300 V AC
Test voltage, routine test (IEC/EN 60255-27)	Supply circuit / Measuring circuit ¹⁾	2.5 kV, 50 Hz, 1 min. (CM-MSS.x2: n/a)
	Supply circuit / Output circuits	2.5 kV, 50 Hz, 1 min.
	Measuring circuit ¹⁾ / Output circuits	2.5 kV, 50 Hz, 1 min.
Test voltage, type test (IEC/EN 60255-27)	Supply circuit / Measuring circuit ¹⁾	6 kV / 1.2 - 50 μs (CM-MSS.x2: n/a)
	Supply circuit / Output circuits	6 kV / 1.2 - 50 μs
	Measuring circuit ¹⁾ / Output circuits	6 kV / 1.2 - 50 μs
	Output circuit 1 / Output circuit 2	6 kV / 1.2 - 50 μs
Protective separation (IEC/EN 61140, EN 50178)	Supply circuit / Measuring circuit ¹⁾	yes, up to 300 V
	Supply circuit / Output circuits	yes (CM-MSS.x2: n/a)
	Measuring circuit ¹⁾ / Output circuits	yes
	Output circuit 1 / Output circuit 2	no
Pollution degree (IEC/EN 60664-1)		3
Overtoltage category (IEC/EN 60664-1)		III

¹⁾ Potential of measuring circuit = Potential of control circuit

Thermistor motor protection relays

Technical data - CM-MSS

Standards		
Product standard		EN 60947-5-1, EN 60947-8
Low Voltage Directive		2014/35/EC
EMC directive		2014/30/EC
ATEX directive		2014/34/EC (only ATEX variants "Selection table CM-MSx range" on page 139)
RoHS directive		2011/65/EC
Electromagnetic compatibility		
Interference immunity to		IEC/EN 61000-6-1, IEC/EN 61000-6-2
electrostatic discharge	IEC/EN 61000-4-2	Level 3, 6 kV contact discharge, 8 kV air discharge
radiated, radio-frequency, electromagnetic field	IEC/EN 61000-4-3	Level 3, 10 V/m (1 GHz), 3 V/m (2 GHz), 1 V/m (2.7 GHz)
electrical fast transient / burst	IEC/EN 61000-4-4	Level 3, 2 kV / 5 kHz
surge	IEC/EN 61000-4-5	Level 3, Installation class 3, supply circuit and measuring circuit 1 kV L-L, 2 kV L-N
conducted disturbances, induced by radio-frequency fields	IEC/EN 61000-4-6	Level 3, 0.15-80 MHz, 10 V, 80 % AM (1kHz)
voltage dips, short interruptions and voltage variations	IEC/EN 61000-4-11	Class 3
harmonics and interharmonics	IEC/EN 61000-4-13	Class 3
Additional interference immunity according to product standard EN 60255-1 (reference on EN 60255-26_2011)		
radiated, radio-frequency, electromagnetic field	IEC/EN 61000-4-3	10 V/m (80 MHz - 3 GHz)
conducted disturbances, induced by radio-frequency fields	IEC/EN 61000-4-6	10 V at stated frequencies
damped oscillatory waves	IEC/EN 61000-4-18	Signal lines, symmetric coupling: 1 kV peak voltage Power supply, asymmetric coupling: 2.5 kV peak voltage
Interference emissions		IEC/EN 61000-6-3, IEC/EN 61000-6-4
high-frequency radiated	IEC/CISPR 22, EN 55022	Class B
high-frequency conducted	IEC/CISPR 22, EN 55022	Class B
high-frequency radiated	Germanischer Lloyd	increased requirements in the emergency call frequency band

Thermistor motor protection relays

Technical data - CM-MSE

Technical data

Data at $T_a = 25\text{ °C}$ and rated values, unless otherwise indicated

Supply circuit - Input circuit		CM-MSE
Rated control supply voltage U_s power consumption	1SVR550805R9300	24 V AC approx. 1.5 A
	1SVR550800R9300	110-130 V AC approx. 1.5 A
	1SVR550801R9300	220-240 V AC approx. 1.5 A
Rated control supply voltage U_s tolerance		-15...+10 %
Rated frequency		50-60 Hz
Measuring circuit		
Monitoring function	T1-T2	temperature monitoring by means of PTC sensors
Number of sensor circuits		1
Sensor circuit		
Temperature threshold (relay de-energizes)		2.7-3.7 k Ω
Temperature hysteresis (relay energizes)		1.7-2.3 k Ω
Short-circuit threshold (relay de-energizes)		<18 Ω
Short-circuit hysteresis (relay energizes)		>45 Ω
Maximum total resistance of sensors connected in series (cold state)		$\leq 1.5\text{ k}\Omega$
Maximum sensor cable length for short-circuit detection		2 x 100 m at 0.75 mm ² , 2 x 400 m at 2.5 mm ²
Response time		<100 ms
Output circuit		
Kind of output	13-14	1 n/o contact
Operational principle		closed-circuit principle (output relay de-energizes if the measured value exceeds/drops below the adjusted threshold)
Contact material		AgCdO
Rated voltage	VDE 0110, IEC 664-1, IEC 60947-1	250 V
Maximum switching voltage		250 V
Rated operating current I_o (IEC/EN 60947-5-1)	AC-12 (resistive) at 230 V	4 A
	AC-15 (inductive) at 230 V	3 A
	DC-12 (resistive) at 24 V	4 A
	DC-13 (inductive) at 24 V	2 A
AC Rating (UL 508)	utilization category (Control Circuit Rating Code)	B 300
	maximum rated operational voltage	300 V AC
	maximum continuous thermal current at B 300	5 A
	maximum making/breaking apparent power at B 300	3600/360 VA
	general purpose rating	250 V AC - 4 A
Mechanical lifetime		30 x 10 ⁶ switching cycles
Electrical lifetime	at AC12, 230 V AC, 4 A	0.1 x 10 ⁶ switching cycles
Maximum fuse rating to achieve short-circuit protection	n/c contact	10 A fast-acting
	n/o contact	10 A fast-acting
General data		
Dimensions (W x H x D)		22.5 x 78 x 78.5 mm (0.89 x 3.07 x 3.09 in)
Duty time		100 %
Weight		approx. 0.11 kg (0.24 lb)
Mounting position		any
Degree of protection	housing / terminals	IP50 / IP20
Ambient temperature range	operation	-20...+60 °C
	storage	-40...+85 °C
Mounting		DIN rail (IEC/EN 60715)
Electrical connection		
Wire size	fine strand with wire end ferrule	2 x 1.5 mm ² (2 x 16 AWG)
	fine strand without wire end ferrule	2 x 0.75-1.5 mm ² (2 x 18-16 AWG)
	rigid	2 x 1-1.5 mm ² (2 x 18-16 AWG)
Stripping length		2 x 0.75-1.5 mm ² (2 x 18-16 AWG)
Tightening torque		0.6-0.8 Nm (5.31-7.08 lb.in)
Standards		
Product standard		IEC 255-6, EN 60255-6
Low Voltage Directive		2006/95/EC
EMC Directive		2004/108/EC, 91/263/EEC, 92/31/EEC, 93/68/EEC, 93/67/EEC
Electromagnetic compatibility		
electrostatic discharge	IEC/EN 61000-4-2	Level 3 (6 kV / 8 kV)
radiated, radio-frequency, electromagnetic field	IEC/EN 61000-4-3	Level 3 (10 V/m)
electrical fast transient /burst	IEC/EN 61000-4-4	Level 3 (2 kV / 5 kHz)
surge	IEC/EN 61000-4-5	Level 3/4 (1/2 kV)
conducted disturbances, induced by radio-frequency fields	IEC/EN 61000-4-6	Level 3 (10 V)
Operational reliability (IEC 68-2-6)		6 g
Resistance to vibration (IEC 68-2-6)		10 g
Environmental testing (IEC 68-2-30)		24 h cycle time, 55 °C, 93 % rel., 96 h
Electromagnetic compatibility		
Rated voltage between supply, measuring and output circuit		250 V
Rated impulse withstand voltage between all isolated circuits		4 kV / 1.2 - 50 μ s
Test voltage between all isolated circuits		2.5 kV, 50 Hz, 1 min.
Pollution degree		3
Overvoltage category		III

Thermistor motor protection relays

Notes

Thermistor motor protection relays

Connection diagrams

2

CM-MSS.11, CM-MSS.21

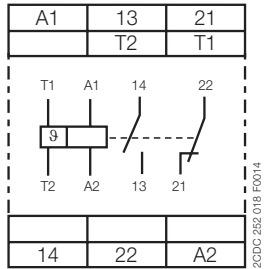

- A1 – A2 Control supply voltage
- 13 – 14 n/o contact
- 21 – 22 n/c contact
- T1 – T2 Measuring circuit

CM-MSS.12

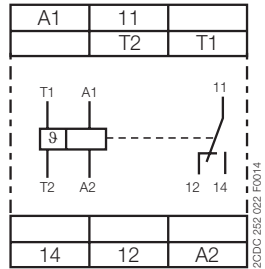

- A1 – A2 Control supply voltage
- 11 – 12/14 c/o contact
- T1 – T2 Measuring circuit

CM-MSS.13

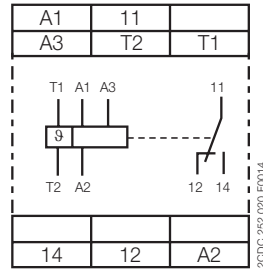

- A1 – A2 Control supply voltage 220-240 V AC
- A2 – A3 Control supply voltage 110-130 V AC
- 11 – 12/14 c/o contact
- T1 – T2 Measuring circuit

CM-MSS.31

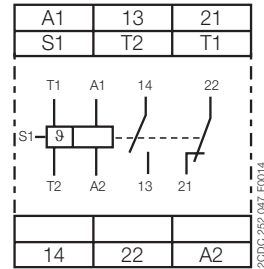

- A1 – A2 Control supply voltage
- 13 – 14 n/o contact
- 21 – 22 n/c contact
- S1 – T2 Automatic reset (jumpered)
- T1 – T2 Measuring circuit

CM-MSS.22, CM-MSS.32, CM-MSS.41

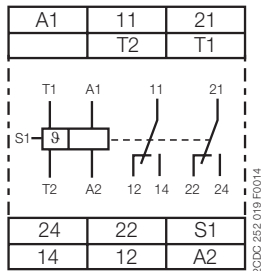

- A1 – A2 Control supply voltage 24 V AC/DC
- 11 – 12/14 1st c/o (SPDT) contact
- 21 – 22/24 2nd c/o (SPDT) contact
- S1 – T2 Automatic reset (jumpered)
- T1 – T2 Measuring circuit

CM-MSS.23, CM-MSS.33

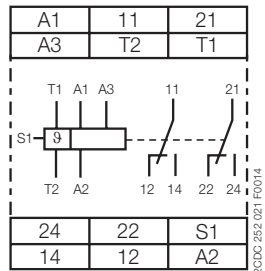

- A1 – A2 Control supply voltage 220-240 V AC
- A2 – A3 Control supply voltage 110-130 V AC
- 11 – 12/14 1st c/o (SPDT) contact
- 21 – 22/24 2nd c/o (SPDT) contact
- S1 – T2 Automatic reset (jumpered)
- T1 – T2 Measuring circuit

CM-MSS.51

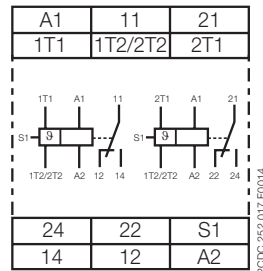

- A1 – A2 Control supply voltage 220-240 V AC
- 11 – 12/14 1st c/o (SPDT) contact
- 21 – 22/24 2nd c/o (SPDT) contact
- S1 – 1T2/2T2 Automatic reset (jumpered)
- 1T1 – 1T2/2T2 Measuring circuit 1
- 2T1 – 1T2/2T2 Measuring circuit 2

CM-MSE

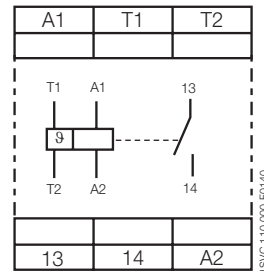

- A1 – A2 Control supply voltage 24 V AC
- T1-T2 Sensor circuit
- 13-14 Output contact - Closed circuit principle

Thermistor motor protection relays

Circuit diagram

CM-MSS.11, CM-MSS.21

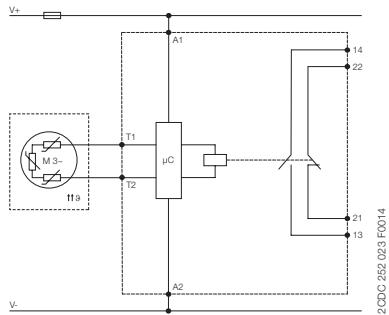

CM-MSS.12

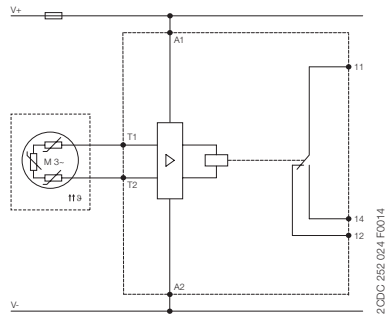

CM-MSS.13

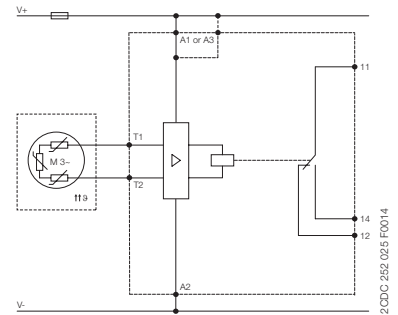

CM-MSS.22

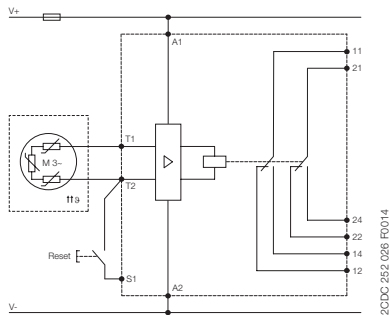

CM-MSS.23

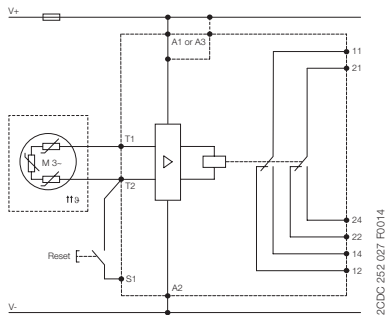

CM-MSS.31

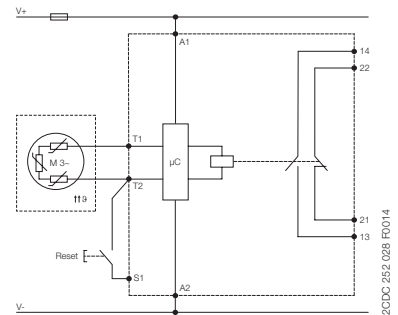

CM-MSS.32, CM-MSS.41

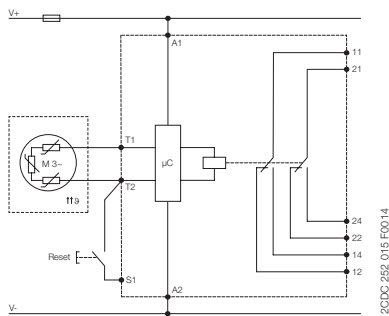

CM-MSS.33

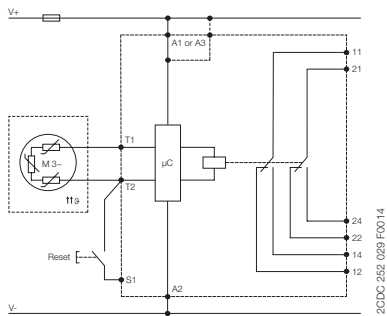

CM-MSS.51

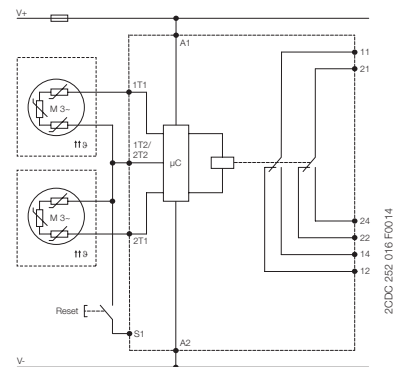

CM-MSE

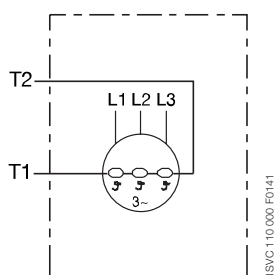

Temperature monitoring relays

Product group picture

2



Temperature monitoring relays

Table of contents

Temperature monitoring relays

Temperature monitoring relays	150
Benefits and advantages, Applications	151
Operating controls	152
Selection	153
Ordering details	154
Function diagrams	155
Overview, Functional description and diagrams	156
Connection diagrams, Resistance thermometer sensors	157
Technical data - CM-TCS.xx	158
Technical data - C51x	160

Temperature monitoring relays

Benefits and advantages, Applications

Overview

The temperature monitoring relays can be used for temperature measurement in solid, liquid and gaseous media. The temperature is acquired by the sensor in the medium, evaluated by the device and monitored to determine whether it is within an operating range (range monitoring function) or has exceeded or fallen below a threshold.

Characteristics CM-TCS

- Adjustable sensor type: PT100
- Functionality like overtemperature monitoring, under-temperature monitoring, temperature window monitoring configurable
- All configurations and adjustments by front-face operating elements
- Precise adjustment with direct reading scales
- One or two threshold values
- Hysteresis 2...20 % adjustable
- Operating temperature range -40...+60 °C
- 1 x 2 c/o or 2 x 1 c/o configurable
- Open- or closed-circuit principle configurable
- Short-circuit monitoring and interrupted wire detection
- 22.5 mm (0.89 in) width
- LEDs for status indication

Functional description

The temperature monitoring relays CM-TCS monitor overtemperature, undertemperature, or temperatures between two threshold values (window monitoring) with PT100 sensor. As soon as the temperature falls below or exceeds the threshold value the output relays change their positions according to the configured functionality and the front-face LEDs display the current status. Regardless of the selected configuration, the device is monitoring its measuring circuit for interrupted wires or short-circuits.

Characteristics C512 + C513

- Adjustable sensor types: PT100, PT1000, KTY83, KTY84, NTC-B57227-K333-A1
- Measuring principle for 2-wire and 3-wire sensors
- Temperature monitor for 1-3 sensor circuits
- Adjustable over-, undertemperature monitoring or range monitoring function
- 2 thresholds
- Hysteresis for both thresholds (1-99 Kelvin)
- Adjustable time delay from 0-999 s affects to both thresholds
- Storage function selectable via external signal (Y1-Y2)
- Non volatile storage of parameter settings
- 1 n/o (for wire-break and short-circuit detection) and 2 c/o
- Multifunctional digital display
- 3 LEDs for status indication
- Open- or closed-circuit principle selectable
- 45 mm wide housing with 24 terminals

C512

- Temperature monitor for 1 sensor circuit

C513

- Temperature monitor for 1-3 sensor circuits
- In the 3-sensor version the status of the single sensors is displayed if the temperature exceeds or falls below the threshold. This way it can be easily determined which one of the connected sensors has exceeded or dropped below either one or both threshold values.

Temperature monitoring relays

Operating controls

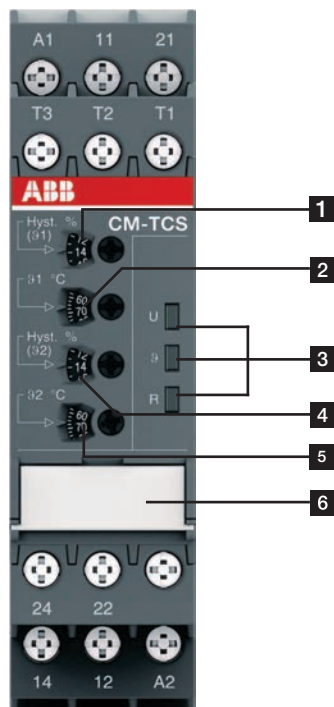

1 Adjustment of the hysteresis for threshold value $\theta 1$

2 Adjustment of the threshold value $\theta 1$

3 Indication of operational states

U: green LED – status indication of control supply voltage

θ : red LED – fault message, state of measuring input

R: yellow LED – status indication of the output relays

4 Adjustment of the hysteresis for threshold value $\theta 2$

5 Adjustment of the threshold value $\theta 2$

6 DIP switch functions / marker label (on page 2/104)

Overtemperature monitoring

Undertemperature monitoring

Temperature window monitoring activated

Temperature window monitoring de-activated

Closed-circuit principle

Open-circuit principle

2 x 1 c/o (SPDT) contact

1 x 2 c/o (SPDT) contacts

Temperature monitoring relays

Selection

2

Type	Order number
CM-TCS.21S	ISVR 730 740 R9100
CM-TCS.21P	ISVR 740 740 R9100
CM-TCS.11S	ISVR 730 740 R0100
CM-TCS.11P	ISVR 740 740 R0100
CM-TCS.22S	ISVR 730 740 R9200
CM-TCS.22P	ISVR 740 740 R9200
CM-TCS.12S	ISVR 730 740 R0200
CM-TCS.12P	ISVR 740 740 R0200
CM-TCS.23S	ISVR 730 740 R9300
CM-TCS.23P	ISVR 740 740 R9300
CM-TCS.13S	ISVR 730 740 R0300
CM-TCS.13P	ISVR 740 740 R0300
C512-24	ISAR 700 100 R0005
C512-W	ISAR 700 100 R0010
C513-W	ISAR 700 110 R0010

Rated control supply voltage U_s

24 V AC/DC	<input type="checkbox"/>	<input type="checkbox"/>	<input type="checkbox"/>	<input type="checkbox"/>	<input type="checkbox"/>	<input type="checkbox"/>	<input type="checkbox"/>	<input type="checkbox"/>	<input type="checkbox"/>	<input type="checkbox"/>	<input type="checkbox"/>	<input type="checkbox"/>	<input type="checkbox"/>	<input type="checkbox"/>	<input type="checkbox"/>	<input type="checkbox"/>	<input type="checkbox"/>	<input type="checkbox"/>
24-240 V AC/DC	<input type="checkbox"/>	<input type="checkbox"/>	<input type="checkbox"/>	<input type="checkbox"/>	<input type="checkbox"/>	<input type="checkbox"/>	<input type="checkbox"/>	<input type="checkbox"/>	<input type="checkbox"/>	<input type="checkbox"/>	<input type="checkbox"/>	<input type="checkbox"/>	<input type="checkbox"/>	<input type="checkbox"/>	<input type="checkbox"/>	<input type="checkbox"/>	<input type="checkbox"/>	<input type="checkbox"/>

Technology

analogue	<input type="checkbox"/>	<input type="checkbox"/>	<input type="checkbox"/>	<input type="checkbox"/>	<input type="checkbox"/>	<input type="checkbox"/>	<input type="checkbox"/>	<input type="checkbox"/>	<input type="checkbox"/>	<input type="checkbox"/>	<input type="checkbox"/>	<input type="checkbox"/>	<input type="checkbox"/>	<input type="checkbox"/>	<input type="checkbox"/>	<input type="checkbox"/>	<input type="checkbox"/>	<input type="checkbox"/>
digital	<input type="checkbox"/>	<input type="checkbox"/>	<input type="checkbox"/>	<input type="checkbox"/>	<input type="checkbox"/>	<input type="checkbox"/>	<input type="checkbox"/>	<input type="checkbox"/>	<input type="checkbox"/>	<input type="checkbox"/>	<input type="checkbox"/>	<input type="checkbox"/>	<input type="checkbox"/>	<input type="checkbox"/>	<input type="checkbox"/>	<input type="checkbox"/>	<input type="checkbox"/>	<input type="checkbox"/>

Sensor circuits (2 or 3 wire)

number of temperature sensors	1	1	1	1	1	1	1	1	1	1	1	1	1	1	1	1	1	3
number of thresholds	2	2	2	2	2	2	2	2	2	2	2	2	2	2	2	2	2	3

Sensor type

PT100	<input type="checkbox"/>	<input type="checkbox"/>	<input type="checkbox"/>	<input type="checkbox"/>	<input type="checkbox"/>	<input type="checkbox"/>	<input type="checkbox"/>	<input type="checkbox"/>	<input type="checkbox"/>	<input type="checkbox"/>	<input type="checkbox"/>	<input type="checkbox"/>	<input type="checkbox"/>	<input type="checkbox"/>	<input type="checkbox"/>	<input type="checkbox"/>	<input type="checkbox"/>	<input type="checkbox"/>
PT100, KTY83, KTY84, NTC, PT1000	<input type="checkbox"/>	<input type="checkbox"/>	<input type="checkbox"/>	<input type="checkbox"/>	<input type="checkbox"/>	<input type="checkbox"/>	<input type="checkbox"/>	<input type="checkbox"/>	<input type="checkbox"/>	<input type="checkbox"/>	<input type="checkbox"/>	<input type="checkbox"/>	<input type="checkbox"/>	<input type="checkbox"/>	<input type="checkbox"/>	<input type="checkbox"/>	<input type="checkbox"/>	<input type="checkbox"/>

Measuring temperature range

-50...+50 °C	<input type="checkbox"/>	<input type="checkbox"/>	<input type="checkbox"/>	<input type="checkbox"/>	<input type="checkbox"/>	<input type="checkbox"/>	<input type="checkbox"/>	<input type="checkbox"/>	<input type="checkbox"/>	<input type="checkbox"/>	<input type="checkbox"/>	<input type="checkbox"/>	<input type="checkbox"/>	<input type="checkbox"/>	<input type="checkbox"/>	<input type="checkbox"/>	<input type="checkbox"/>	<input type="checkbox"/>
0...+100 °C	<input type="checkbox"/>	<input type="checkbox"/>	<input type="checkbox"/>	<input type="checkbox"/>	<input type="checkbox"/>	<input type="checkbox"/>	<input type="checkbox"/>	<input type="checkbox"/>	<input type="checkbox"/>	<input type="checkbox"/>	<input type="checkbox"/>	<input type="checkbox"/>	<input type="checkbox"/>	<input type="checkbox"/>	<input type="checkbox"/>	<input type="checkbox"/>	<input type="checkbox"/>	<input type="checkbox"/>
0...+200 °C	<input type="checkbox"/>	<input type="checkbox"/>	<input type="checkbox"/>	<input type="checkbox"/>	<input type="checkbox"/>	<input type="checkbox"/>	<input type="checkbox"/>	<input type="checkbox"/>	<input type="checkbox"/>	<input type="checkbox"/>	<input type="checkbox"/>	<input type="checkbox"/>	<input type="checkbox"/>	<input type="checkbox"/>	<input type="checkbox"/>	<input type="checkbox"/>	<input type="checkbox"/>	<input type="checkbox"/>
-50...+500 °C	<input type="checkbox"/>	<input type="checkbox"/>	<input type="checkbox"/>	<input type="checkbox"/>	<input type="checkbox"/>	<input type="checkbox"/>	<input type="checkbox"/>	<input type="checkbox"/>	<input type="checkbox"/>	<input type="checkbox"/>	<input type="checkbox"/>	<input type="checkbox"/>	<input type="checkbox"/>	<input type="checkbox"/>	<input type="checkbox"/>	<input type="checkbox"/>	<input type="checkbox"/>	<input type="checkbox"/>

Monitoring function

overtemperature	<input type="checkbox"/>	<input type="checkbox"/>	<input type="checkbox"/>	<input type="checkbox"/>	<input type="checkbox"/>	<input type="checkbox"/>	<input type="checkbox"/>	<input type="checkbox"/>	<input type="checkbox"/>	<input type="checkbox"/>	<input type="checkbox"/>	<input type="checkbox"/>	<input type="checkbox"/>	<input type="checkbox"/>	<input type="checkbox"/>	<input type="checkbox"/>	<input type="checkbox"/>	<input type="checkbox"/>
undertemperature	<input type="checkbox"/>	<input type="checkbox"/>	<input type="checkbox"/>	<input type="checkbox"/>	<input type="checkbox"/>	<input type="checkbox"/>	<input type="checkbox"/>	<input type="checkbox"/>	<input type="checkbox"/>	<input type="checkbox"/>	<input type="checkbox"/>	<input type="checkbox"/>	<input type="checkbox"/>	<input type="checkbox"/>	<input type="checkbox"/>	<input type="checkbox"/>	<input type="checkbox"/>	<input type="checkbox"/>
window temperature	<input type="checkbox"/>	<input type="checkbox"/>	<input type="checkbox"/>	<input type="checkbox"/>	<input type="checkbox"/>	<input type="checkbox"/>	<input type="checkbox"/>	<input type="checkbox"/>	<input type="checkbox"/>	<input type="checkbox"/>	<input type="checkbox"/>	<input type="checkbox"/>	<input type="checkbox"/>	<input type="checkbox"/>	<input type="checkbox"/>	<input type="checkbox"/>	<input type="checkbox"/>	<input type="checkbox"/>

Operating principle

open or closed principle	<input type="checkbox"/>	<input type="checkbox"/>	<input type="checkbox"/>	<input type="checkbox"/>	<input type="checkbox"/>	<input type="checkbox"/>	<input type="checkbox"/>	<input type="checkbox"/>	<input type="checkbox"/>	<input type="checkbox"/>	<input type="checkbox"/>	<input type="checkbox"/>	<input type="checkbox"/>	<input type="checkbox"/>	<input type="checkbox"/>	<input type="checkbox"/>	<input type="checkbox"/>	<input type="checkbox"/>
--------------------------	--------------------------	--------------------------	--------------------------	--------------------------	--------------------------	--------------------------	--------------------------	--------------------------	--------------------------	--------------------------	--------------------------	--------------------------	--------------------------	--------------------------	--------------------------	--------------------------	--------------------------	--------------------------

Output contacts

n/o	<input type="checkbox"/>	<input type="checkbox"/>	<input type="checkbox"/>	<input type="checkbox"/>	<input type="checkbox"/>	<input type="checkbox"/>	<input type="checkbox"/>	<input type="checkbox"/>	<input type="checkbox"/>	<input type="checkbox"/>	<input type="checkbox"/>	<input type="checkbox"/>	<input type="checkbox"/>	<input type="checkbox"/>	<input type="checkbox"/>	<input type="checkbox"/>	<input type="checkbox"/>	<input type="checkbox"/>
c/o	2	2	2	2	2	2	2	2	2	2	2	2	2	2	2	2	2	2

Temperature monitoring relays

Ordering details



CM-TCS



C512, C513

Description

The temperature monitoring relays of CM-TCS and C51x range are able to measure temperatures of solids, liquids and gaseous media using different types of sensors. Overtemperature and undertemperature monitoring as well as open- or closed-circuit principle is configurable for all devices. As soon as the temperature falls below or exceeds the set threshold value the output relays change their positions according to the configured functionality and the front-face LED's display the current status.

Ordering details - Temperature monitoring relays CM-TCS

Rated control supply voltage	Measuring range	Temperature sensors	Type	Order code	Price	Weight (1 pce)
					1 pce	kg (lb)
24-240 V AC/DC	-50...+50 °C	PT100	CM-TCS.11S	1SVR730740R0100		0.151 (0.333)
			CM-TCS.11P	1SVR740740R0100		0.140 (0.309)
	0...+100 °C		CM-TCS.12S	1SVR730740R0200		0.151 (0.333)
			CM-TCS.12P	1SVR740740R0200		0.140 (0.309)
	0...+200 °C		CM-TCS.13S	1SVR730740R0300		0.151 (0.333)
			CM-TCS.13P	1SVR740740R0300		0.140 (0.309)
24 V AC/DC	-50...+50 °C	CM-TCS.21S	1SVR730740R9100		0.138 (0.304)	
		CM-TCS.21P	1SVR740740R9100		0.127 (0.280)	
	0...+100 °C	CM-TCS.22S	1SVR730740R9200		0.138 (0.304)	
		CM-TCS.22P	1SVR740740R9200		0.127 (0.280)	
	0...+200 °C	CM-TCS.23S	1SVR730740R9300		0.138 (0.304)	
		CM-TCS.23P	1SVR740740R9300		0.127 (0.280)	

S: screw connection
P: push-in connection

Ordering details - Temperature monitoring relays C51x

Rated control supply voltage	Measuring range	Temperature sensors	Type	Order code	Price	Weight (1 pce)
					1 pce	kg (lb)
24 V AC/DC	-50...+500 °C	PT100, PT1000, NTC, KTY84, KTY83	C512-24	1SAR700100R0005		0.32 (0.71)
24-240 V AC/DC			C512-W	1SAR700100R0010		0.33 (0.73)
24-240 V AC/DC			C513-W	1SAR700110R0010		0.34 (0.75)

Ordering details - replaceable cover C51x

Use for	Language	Type	Order code	Price	Weight (1 pce)
				5 pce	kg (lb)
C512	German	C512-D	1SVR700101R0100		
C512	English	C512-E	1SVR700102R0100		
C513	German	C513-D	1SVR700111R0100		
C513	English	C513-E	1SVR700112R0100		



Further documentation temperature monitoring relays on www.abb.com

Temperature monitoring relays

Function diagrams

CM-TCS - Overtemperature monitoring, 1 x 2 c/o contacts 1x2 c/o

With this configuration, settings via ϑ_2 have no influence on the operating function (ϑ_2 disabled).

Open-circuit principle:

If the measured value is correct, the output relays remain de-energized when control supply voltage is applied. If the measured value exceeds the adjusted threshold value ϑ_1 , the output relays energize. If the measured value drops again below the adjusted threshold value ϑ_1 minus the adjusted hysteresis, the output relays de-energize.

Closed-circuit principle:

The behavior is inverse to the one with open-circuit principle.

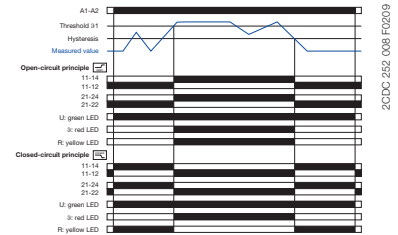

2CDC 252.008 F0209

Overtemperature monitoring, 2 x 1 c/o contact 2x1 c/o

Open-circuit principle:

If the measured value is correct, the output relays remain de-energized when control supply voltage is applied. If the measured value exceeds the adjusted threshold value ϑ_2 , output relay R2 (prewarning) energizes. If the measured value exceeds the adjusted threshold value ϑ_1 , output relay R1 (final switch-off) energizes.

If the measured value drops again below the adjusted threshold value ϑ_1 minus the adjusted hysteresis, output relay R1 (final switch-off) de-energizes. If the measured value drops below the adjusted threshold value ϑ_2 minus the adjusted hysteresis, output relay R2 (prewarning) de-energizes.

Closed-circuit principle:

The behavior is inverse to the one with open-circuit principle.

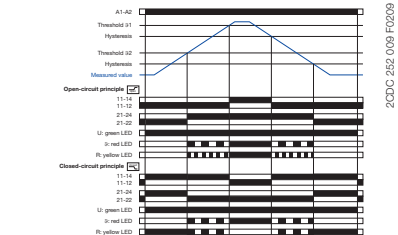

2CDC 252.009 F0209

Undertemperature monitoring, 1 x 2 c/o contacts 1x2 c/o

With this configuration, settings via ϑ_1 have no influence on the operating function (ϑ_1 disabled).

Open-circuit principle:

If the measured value is correct, the output relays remain de-energized when control supply voltage is applied. If the measured value drops below the adjusted threshold value ϑ_2 , the output relays energize. If the measured value exceeds again the adjusted threshold value ϑ_2 plus the adjusted hysteresis, the output relays de-energize.

Closed-circuit principle:

The behavior is inverse to the one with open-circuit principle.

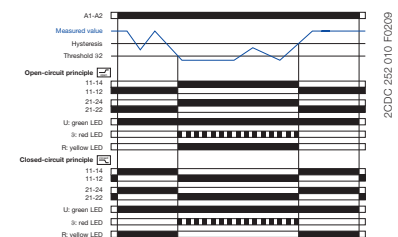

2CDC 252.010 F0209

Undertemperature monitoring, 2 x 1 c/o contact 2x1 c/o

Open-circuit principle:

If the measured value is correct, the output relays remain de-energized when control supply voltage is applied. If the measured value drops below the adjusted threshold value ϑ_1 , output relay R1 (prewarning) energizes. If the measured value drops below the adjusted threshold value ϑ_2 , output relay R2 (final switch-off) energizes.

If the measured value exceeds again the adjusted threshold value ϑ_2 plus the adjusted hysteresis, output relay R2 (final switch-off) de-energizes. If the measured value exceeds the adjusted threshold value ϑ_1 plus the adjusted hysteresis, output relay R1 (prewarning) de-energizes.

Closed-circuit principle:

The behavior is inverse to the one with open-circuit principle.

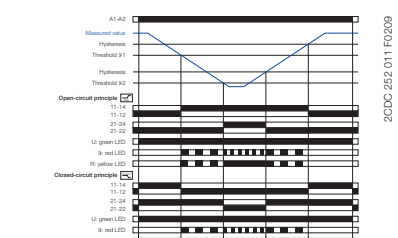

2CDC 252.011 F0209

Temperature window monitoring, 1 x 2 c/o contacts 1x2 c/o

Open-circuit principle:

If the measured value is correct, the output relays remain de-energized when control supply voltage is applied. If the measured value exceeds the adjusted threshold value ϑ_1 or drops below the adjusted threshold value ϑ_2 , the output relays energize. If the measured value drops again below the adjusted threshold value ϑ_1 minus the adjusted hysteresis or exceeds again the adjusted threshold value ϑ_2 plus the adjusted hysteresis, the output relays de-energize.

Closed-circuit principle:

The behavior is inverse to the one with open-circuit principle.

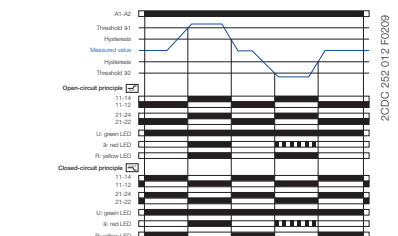

2CDC 252.012 F0209

Temperature window monitoring, 2 x 1 c/o contact 2x1 c/o

Open-circuit principle:

If the measured value is correct, the output relays remain de-energized when control supply voltage is applied. If the measured value exceeds the adjusted threshold value ϑ_1 or drops below the adjusted threshold value ϑ_2 , output relay R1 ($>\vartheta_1$) or R2 ($<\vartheta_2$) respectively energizes.

If the measured value drops again below the adjusted threshold value ϑ_1 minus the adjusted hysteresis or exceeds again the adjusted threshold value ϑ_2 plus the adjusted hysteresis, output relay R1 ($>\vartheta_1$) or R2 ($<\vartheta_2$) respectively de-energizes.

Closed-circuit principle:

The behavior is inverse to the one with open-circuit principle.

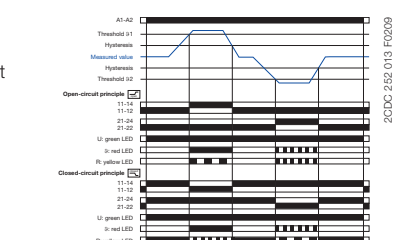

2CDC 252.013 F0209

Temperature monitoring relays

Overview, Functional description and diagrams

Functional description

Digital tripping devices

Once the temperature has reached the set threshold of ϑ_1 , output relay K1 changes its switching state after the set time delay t has elapsed (K2 reacts in the same way for ϑ_2).

Characteristic curves of resistance sensors

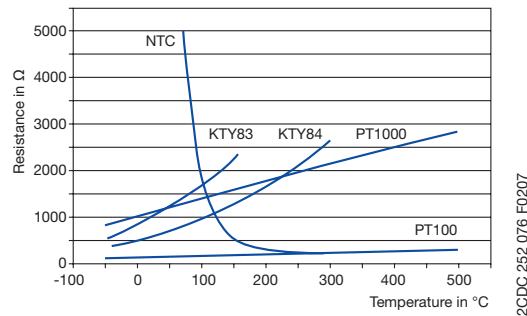

DIP switches CM-TCS

Position	4	3	2	1
ON ↑	2x1 c/o	closed	←	↘
OFF	1x2 c/o	open	⊗	↘

Function diagrams

Overtemperature - C512/C513

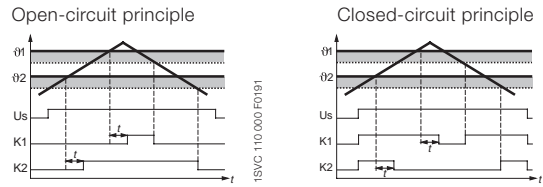

Undertemperature - C512/C513

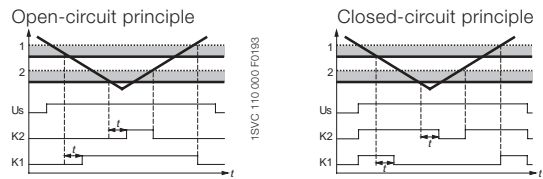

Range monitoring - C512/C513

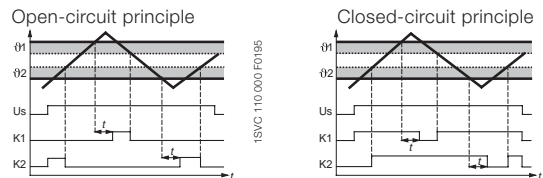

Function principle with storage function - C512/C513

using overtemperature with closed-circuit principle as an example

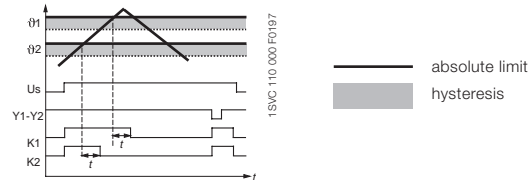

	ON	OFF (default)
DIP switch 1 Monitoring principle	Overtemperature monitoring <input checked="" type="checkbox"/> If overtemperature monitoring is selected, the CM-TCS recognizes temperatures above the selected threshold and trips the output relay according to the selected operating principle.	Undertemperature monitoring <input checked="" type="checkbox"/> If undertemperature monitoring is selected, the CM-TCS recognizes temperatures below the selected threshold and trips the output relay according to the selected operating principle.
DIP switch 2 Temperature window monitoring	Temperature window monitoring activated <input checked="" type="checkbox"/> If temperature window monitoring is selected, the CM-TCS monitors over- and undertemperature. If temperature window monitoring is activated, DIP switch 1 is disabled.	Temperature window monitoring de-activated <input type="checkbox"/> Temperature window monitoring is de-selected.
DIP switch 3 Operating principle of the output relays	Closed-circuit principle <input checked="" type="checkbox"/> If closed-circuit principle is selected, the output relays are energized. They de-energize if a fault is occurring.	Open-circuit principle <input checked="" type="checkbox"/> If open-circuit principle is selected, the output relays are deenergized. They energize if a fault is occurring.
DIP switch 4 2 x 1 c/o contact, 1 x 2 c/o contacts	2 x 1 c/o (SPDT) contact <input checked="" type="checkbox"/> If operating principle 2 x 1 c/o contact is selected, the output relay R1 (11-12/14) reacts to threshold value ϑ_1 and the output relay R2 (21-22/24) reacts to threshold value ϑ_2 .	1 x 2 c/o (SPDT) contacts <input checked="" type="checkbox"/> If operating principle 1 x 2 c/o contacts is selected, both output relays R1 (11-12/14) and R2 (21-22/24) react synchronously to one threshold value. Overtemperature monitoring: Settings of the threshold value ϑ_2 have no effect on the operation. Undertemperature monitoring: Settings of the threshold values ϑ_2 have no effect on the operation.

Temperature monitoring relays

Connection diagrams, Resistance thermometer sensors

Connection diagrams

2

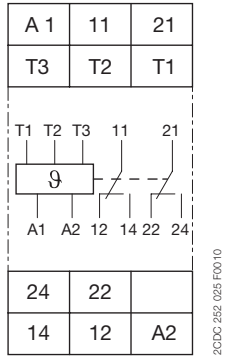

2CDC 252 025 F0010

CM-TCS

- A1-A2 Control supply voltage
- 11-12/14 Output relay R1
- 21-22/24 Output relay R2
- T1, T2, T3 Measuring input, connection PT100

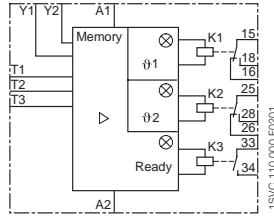

C512

- A1-A2 Rated control supply voltage
- 15-16/18 Output contacts
- 25-26/28
- 33-34
- T1-T3 Sensor connection
- Y1-Y2 Connection for storage bridge

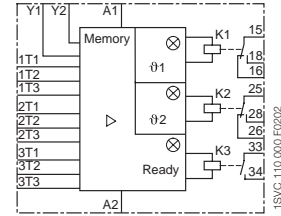

C513

- A1-A2 Rated control supply voltage
- 15-16/18 Output contacts
- 25-26/28
- 33-34
- 1T1-1T3 Sensor connection 1
- 2T1-2T3 Sensor connection 2
- 3T1-3T3 Sensor connection 3
- Y1-Y2 Connection for storage bridge

Connection of resistance thermometer sensors

2-wire measurement

When using 2-wire temperature sensors the sensor resistance and the wire resistance are added together. The resulting systematic errors must be taken into account when adjusting the tripping device.

A jumper must be connected between the terminals T2 and T3.

The following table can be used for PT100 sensors to determine the temperature errors caused by the line length.

When using resistance sensors with two-wire connection a bridge must be inserted between terminals T2 and T3.

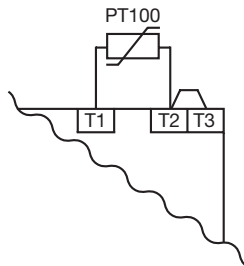

Error caused by the line

The error resulting from the line resistance amounts to approx. 2.5 Kelvin/Ohm. If the resistance of the line is not known and it is not possible to measure it, the error caused by the line can be estimated using the following table.

Temperature error

(depending on the line length and conductor cross section for PT100 sensors at an ambient temperature of 20 °C, in K)

Line length in m	Wire size mm ²			
	0.50	0.75	1	1.5
0	0.0	0.0	0.0	0.0
10	1.8	1.2	0.9	0.6
25	4.5	3.0	2.3	1.5
50	9.0	6.0	4.5	3.0
75	13.6	9.0	6.8	4.5
100	18.1	12.1	9.0	6.0
200	36.3	24.2	18.1	12.1
500	91.6	60.8	45.5	30.2

3-wire measurement

To minimize the influence of the wire resistance, a three-wire connection is usually used. By means of the additional wire two measuring circuits are created.

One of these two circuits is used for reference. This way, the tripping device can calculate and take into account the wire resistance automatically.

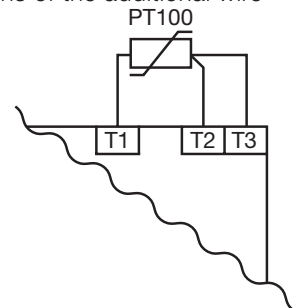

Electrical isolation

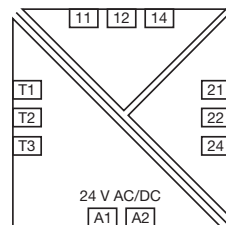

2CDC 252 019 F0010

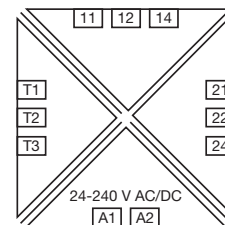

2CDC 252 020 F0010

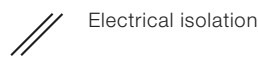

Electrical isolation



Protective separation acc. to IEC/EN 61140; EN 50178

Temperature monitoring relays

Technical data - CM-TCS.xx

Type		CM-TCS.11/12/13	CM-TCS.21/22/23
Input circuit			
Rated control supply voltage U_s	A1-A2	24-240 V AC/DC	24 V AC/DC
Rated control supply voltage U_s tolerance		-15...+10 %	
Typical current / power / consumption	24 V DC	33 mA / 0.8 VA	18 mA / 0.45 VA
	115 V AC	12.5 mA / 1.5 VA	n/a
	230 V AC	13 mA / 2.9 VA	n/a
Rated frequency	AC	15-400 Hz	50/60 Hz
Frequency range	AC	13.5-440 Hz	45-65 Hz
Power failure buffering time	min.	20 ms	
Measuring circuit		T1, T2, T3	
Sensor type		PT100	
Connection of the sensor	2-wire	yes, jumper between T2-T3	
	3-wire	yes, use terminal T1, T2, T3	
Monitoring function		overtemperature, undertemperature or window monitoring	
Threshold values adjustable within the measuring range	CM-TCS.x1	-50...+50 °C	
	CM-TCS.x2	0...+100 °C	
	CM-TCS.x3	0...+200 °C	
Number of possible thresholds		2	
Tolerance of the adjusted threshold value		typ. ± 5 % of the range end value	
Hysteresis related to the threshold value		2-20 % of threshold value, min. 1 °C	
Measuring principle		continuous current	
Typical current in the sensor circuit		0.8 mA	
Maximum current in sensor circuit		0.9 mA	
Interrupted wire detection		yes, indicated via LED status	
Short-circuit detection		yes, indicated via LED status	
Accuracy within the rated control supply voltage tolerance		< 0.2 °C / or < 0.01 %/K	
Accuracy within the temperature range		< 0.2 °C / or < 0.01 %/K	
Repeat accuracy (constant parameters)		< 0.2 % of full scale	
Maximum measuring cycle		320 ms	
Output circuit			
Kind of output		2 x 1 or 1 x 2 c/o (SPDT) contacts configurable	
Operating principle		open- or closed-circuit principle configurable ¹⁾	
Contact material		AgNi alloy, Cd free	
Rated operational voltage (IEC/EN 60947-1)		250 V AC / 300 V DC	
Minimum switching voltage / Minimum switching current		24 V / 10 mA	
Maximum switching voltage / Maximum switching current		see 'Load limit curves'	
Rated operating current I_e (IEC/EN 60947-1-5)	AC-12 (resistive) 230 V	4 A	
	AC-15 (inductive 230 V	3 A	
	DC-12 (resistive) 24 V	4 A	
	DC-13 (inductive) 24 V	2 A	
AC Rating (UL508)	utilization category	B 300, pilot duty general purpose (250 V, 4 A, $\cos \phi$ 0.75)	
	maximum rated operational voltage	250 V AC	
	maximum continuous thermal current at B 300	4 A	
	maximum making/breaking apparent power at B 300	3600/360 VA	
Mechanical lifetime		30 x 10 ⁶ switching cycles	
Electrical lifetime (AC-12, 230 V, 4 A)		0.1 x 10 ⁶ switching cycles	
Maximum fuse rating to achieve short-circuit protection	n/c contact	6 A fast-acting	
	n/o contact	10 A fast-acting	
Conventional thermal current I_{th} acc. IEC/EN 60947-1		4 A	
General data			
Dimensions (W x H x D)		22.5 x 85.6 x 103.7 mm (0.89 x 3.37 x 4.08 in)	
Mounting position		any	
Weight	net weight	CM-TCS.1x	0.151 kg (0.333 lb)
		CM-TCS.2x	0.138 kg (0.304 lb)
	gross weight	CM-TCS.1x	0.176 kg (0.388 lb)
		CM-TCS.2x	0.163 kg (0.360 lb)
Degree of protection	enclosure / terminals	IP50 / IP20	
Ambient temperature range	operation	-40...+60 °C	
	storage/transport	-40...+85 °C	
Mounting		DIN rail (IEC/EN 60715), snap-on mounting without any tool	

¹⁾ Closed-circuit principle: Output relay(s) de-energize(s) if measured value exceeds or falls below the adjusted threshold value

Temperature monitoring relays

Technical data - CM-TCS.xx

2

Type		CM-TCS.11/12/13	CM-TCS.21/22/23	
Electrical connection				
Wire size	fine-strand without wire end ferrule	A1, A2, 11, 12, 14, 21, 22, 24	Screw connection technology 1 x 0.5-2.5 mm ² (1 x 20-14 AWG) 2 x 0.5-1.5 mm ² (2 x 20-16 AWG)	Easy Connect Technology (Push-in) 2 x 0.5-1.5 mm ² (2 x 20-16 AWG) connection with lever
		T1, T2, T3	1 x 0.2-2.5 mm ² (1 x 24-14 AWG) 2 x 0.2-1.5 mm ² (2 x 24-16 AWG)	2 x 0.2-1.5 mm ² (2 x 24-16 AWG) connection with lever
	fine-strand with wire end ferrule	A1, A2, 11, 12, 14, 21, 22, 24	1 x 0.5-2.5 mm ² (1 x 20-14 AWG) 2 x 0.5-1.5 mm ² (2 x 20-16 AWG)	2 x 0.5-1.5 mm ² (2 x 20-16 AWG) connection: push-in
		T1, T2, T3	1 x 0.2-2.5 mm ² (1 x 24-14 AWG) 2 x 0.2-1.5 mm ² (2 x 24-16 AWG)	2 x 0.2-1.5 mm ² (2 x 24-16 AWG) insulated ferrule (DIN 46228-4-E): connection: push-in ferrule (DIN 46228-1-A): < 0.5 mm ² , connection with lever ≥ 0.5 mm ² , connection: push-in
	rigid	A1, A2, 11, 12, 14, 21, 22, 24	1 x 0.5-4 mm ² (1 x 20-12 AWG) 2 x 0.5-2.5 mm ² (2 x 20-14 AWG)	2 x 0.5-1.5 mm ² (2 x 20-16 AWG) connection: push-in
		T1, T2, T3	1 x 0.2-4 mm ² (1 x 24-12 AWG) 2 x 0.2-2.5 mm ² (2 x 24-14 AWG)	2 x 0.2-1.5 mm ² (2 x 24-16 AWG) < 0.5 mm ² , connection with lever ≥ 0.5 mm ² , connection: push-in
Stripping length		8 mm (0.32 in)		
Tightening torque	< 0.5 mm ²	0.5 Nm (4.43 lb.in)	-	
	≥ 0.5 mm ²	0.6 - 0.8 Nm (5.31 - 7.08 lb.in)	-	
Standards				
Product standard		IEC/EN 60255-1, IEC/EN 60255-27, EN 50178		
Low Voltage Directive		2006/95/EC		
EMC Directive		2004/108/EC		
RoHS Directive		2011/65/EC		
Environmental data				
Ambient temperature ranges	operation/storage/ transport	-40...+60°C/-40...+85°C/-40...+85°C		
Climatic category		3K5 (no condensation, no ice formation)		
Damp heat, cyclic		6 x 24 h cycle, 55 °C, 95 % RH		
Vibration, sinusoidal		Class 2		
Shock		Class 2		
Isolation data				
Rated impulse withstand voltage	supply circuit / measuring circuit	4 kV	-	
U _{imp} between all isolated circuits (IEC/EN 60947-1, IEC/EN 60664-1)	supply circuit / output circuits	4 kV		
	measuring circuit / output circuits	4 kV		
Pollution degree (IEC/EN 60664-1)	output circuit 1 / output circuit 2	4 kV		
		3		
Overvoltage category (IEC/EN 60664-1)		III		
Rated insulation voltage U _i (IEC/EN 60947-1, IEC/EN 60664-1)	supply circuit / measuring circuit	300 V	-	
	supply circuit / output circuits	300 V		
	measuring circuit / output circuits	300 V		
	output circuit 1 / output circuit 2	300 V		
Basis isolation for rated control supply voltage (IEC/EN 60664-1)	supply circuit / measuring circuit	250 V AC / 300 V DC	-	
	supply circuit / output circuits	250 V AC / 300 V DC		
	measuring circuit / output circuits	250 V AC / 300 V DC		
	output circuit 1 / output circuit 2	250 V AC / 300 V DC		
Protective separation (IEC/EN 61140, EN 50178)	supply circuit / measuring circuit	250 V AC / 250 V DC	-	
	supply circuit / output circuits	250 V AC / 300 V DC	250 V AC / 250 V DC	
	measuring circuit / output circuits	250 V AC / 300 V DC	250 V AC / 250 V DC	
Test voltage between all isolated circuits, routine test (IEC/EN 60255-5, IEC/EN 61010-1)	supply circuit / measuring circuit	2.0 kV, 50 Hz, 1 s	-	
	supply circuit / output circuits	2.0 kV, 50 Hz, 1 s		
	measuring circuit / output circuits	2.0 kV, 50 Hz, 1 s		
Test voltage between all isolated circuits, type test (IEC/EN 60255-5)	supply circuit / measuring circuit	4.0 kV, 50 Hz, 1 s	-	
	supply circuit / output circuits	4.0 kV, 50 Hz, 1 s		
	measuring circuit / output circuits	4.0 kV, 50 Hz, 1 s		
		4.0 kV, 50 Hz, 1 s		
Electromagnetic compatibility				
Interference immunity to		IEC/EN 61000-6-1, IEC/EN 61000-6-2, IEC/EN 61326-2-4		
electrostatic discharge	IEC/EN 61000-4-2	Level 3, 6 kV / 8 kV		
radiated, radio-frequency, electromagnetic field	IEC/EN 61000-4-3	Level 3, 10 V/m (1 GHz) / 3 V/m (2 GHz) / 1 V/m (2.7 GHz)		
electrical fast transient/burst surge	IEC/EN 61000-4-4	Level 3, 2 kV / 5 kHz		
	IEC/EN 61000-4-5	Level 3, installation class 3, supply circuit and measuring circuit 1 kV L-L, 2 kV L-earth		
conducted disturbances, induced by radio-frequency fields	IEC/EN 61000-4-6	Level 3, 10 V		
voltage dips, short interruptions and voltage variations	IEC/EN 61000-4-11	Class 3		
harmonics and interharmonics	IEC/EN 61000-4-13	Class 3		
Interference emission		EN 61000-6-3, EN 61000-6-4		
high-frequency radiated	IEC/CISPR 22, EN 55022	Class B		
high-frequency conducted	IEC/CISPR 22, EN 55022	Class B		

Temperature monitoring relays

Technical data - C51x

Type		C512	C513
Input circuit			
Rated control supply voltage U_s	A1-A2	24 V AC/DC	-
Power consumption	A1-A2	24-240 V AC/DC	
	AC	< 7 VA	
Rated control supply voltage U_s tolerance	DC	< 4 W	
		-15...+10 %	
Rated frequency	AC		
Sensor circuit			
Sensor type		PT100, PT1000, KTY83, KTY84, NTC	
Sensor current	PT100	typ. 1 mA	
	PT1000, KTY83, KTY84, NTC	typ. 0.2 mA	
Wire-break detection		yes (not for NTC)	
Short-circuit detection		yes	
3-wire connection		yes (2-wire connection of sensors with terminals T2 and T3 bridged)	
Measuring circuit			
Setting accuracy at $T_a = 20\text{ °C}$ (T_{20})		< $\pm 2\text{ K} \pm 1$ digit	
Accuracy within the temperature range		0.05 °C / °C deviation from T_{20}	
Response time		500 ms	
Hysteresis settings	temperature 1	1-99 kelvin	
	temperature 2	1-99 kelvin	
Tripping delay		0-999 s	
Output circuit			
Kind of output		2 c/o + 1n/o	2 c/o + 1 n/o
Rated operating current I_o (IEC/EN 60947-1-5)	AC-12 (resistive) 230 V	n/a	
	AC-15 (inductive) 230 V	3 A	
	DC-12 (resistive) 24 V	1 A	
	DC-13 (inductive) 24 V	0.1 A	
Mechanical lifetime		30 x 10 ⁶ switching cycles	
Electrical lifetime (AC-15 at 3 A)		0.1 x 10 ⁶ switching cycles	
Max. fuse rating to achieve short-circuit protection		4 A, operating class gL/gG	
General data			
Dimensions (W x H x D)		45 x 105.9 x 86 mm (1.77 x 4.17 x 3.39 in)	
Tightening torque		0.8-1.2 Nm	
Mounting position		any	
Degree of protection	enclosure / terminals	IP 40 / IP 20	
Ambient temperature range	operation	-25...+60 °C	
	storage	-40...+80 °C	
Mounting		DIN rail (IEC/EN 60715)	
Electrical connection			
Wire size	rigid	1 x 4 mm ² (1 x 12 AWG), 2 x 2.5 mm ² (2 x 14 AWG)	
	fine-strand with wire end ferrule	1 x 2.5 mm ² (1 x 14 AWG), 2 x 1.5 mm ² (2 x 16 AWG)	
Standards			
Environmental conditions		IEC 60721-3-3	
Low Voltage Directive		IEC 60947-5-1, VDE 0660	
Electromagnetic compatibility	Interference immunity	EN 61000-6-2	
	Interference emission	EN 61000-6-4	
Vibration resistance (IEC 68-2-6)		5-26 Hz / 0.75 mm	
Shock resistance (IEC 68-2-27)		15 g / 11 ms	
Isolation data			
Rated insulation voltage		300 V AC	
Pollution degree		3	

Liquid level monitors and controls

Product group picture

2

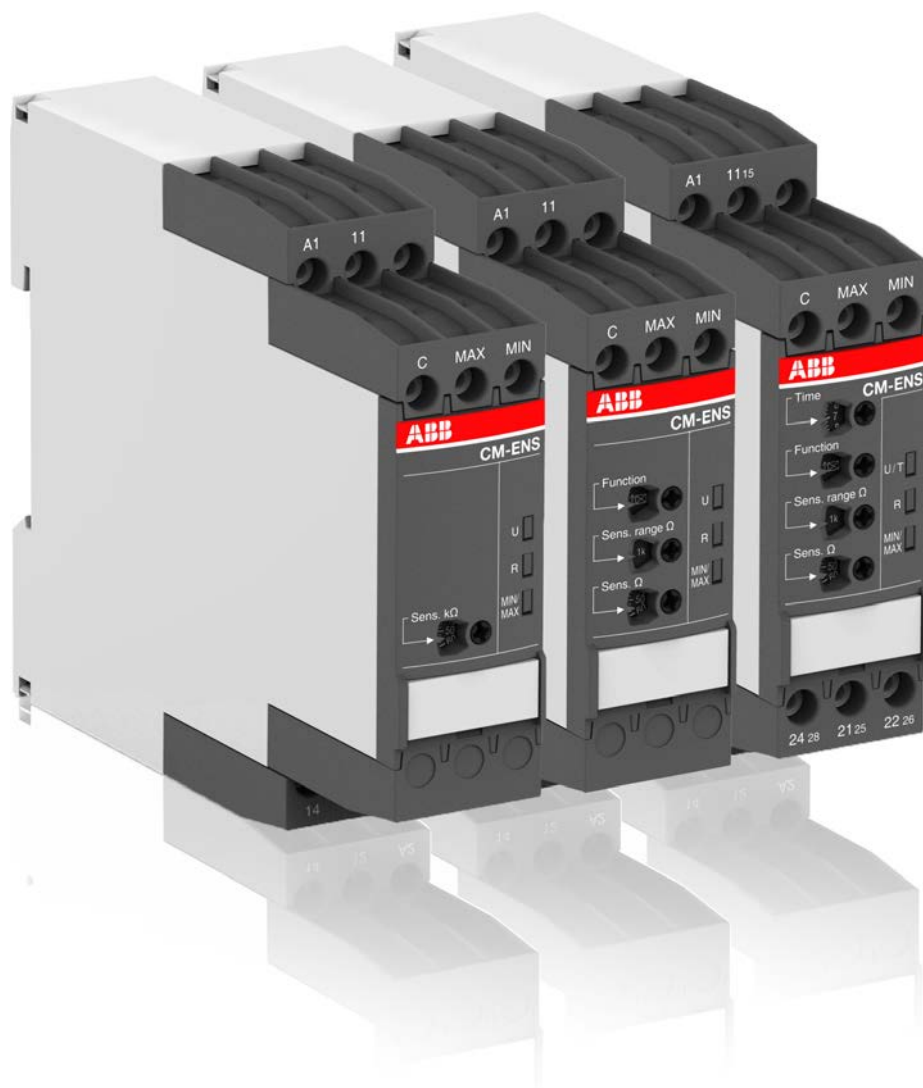

Liquid level monitors and controls

Table of contents

Liquid level monitors and controls

Liquid level monitors and controls	162
Benefits and advantages	163
Selection	165
Ordering details	166
Function diagrams	167
Connection diagrams	168
Cascading of several devices, application examples	169
Technical data - CM-ENE	170
Technical data - CM-ENS	171

Liquid level monitors and controls

Benefits and advantages

2

CM-ENS.1x

- Control of one or two liquid levels (min/max)
- Fill or drain function
- Adjustable response sensitivity 5-100 k Ω

CM-ENS.2x

- Control of one or two liquid levels (min/max)
- Fill (UP) or Drain (DOWN), adjustable via front-face potentiometer
- Adjustable response sensitivity 0.1-1000 k Ω

CM-ENS.31

- Control of one or two liquid levels (min/max)
- Fill (UP) or Drain (DOWN), adjustable via front-face potentiometer
- Adjustable response sensitivity 0.1-1000 k Ω
- Selectable ON- or OFF-delay
- 2 c/o (SPDT) contacts

All CM-ENS devices

- Devices with wide rated control supply voltage 24-240 V AC/DC
- Cascadable
- High EMC immunity
- 3 LEDs for the indication of operational states
- Screw connection technology or Easy Connect Technology
- Housing material for highest fire protection classification UL 94 V-0
- Tool-free mounting and demounting on DIN rail
- 22.5 mm (0.89 in) width

ABB's liquid level monitoring relays are the ideal solution to regulate and control liquid levels and ratios of mixtures of conductive fluids. The assortment includes single- or multifunctional devices which can be used for overflow protection, dry-running protection of pumps, filling and draining applications as well as max. and min. level alarming.



Global availability

You will find ABB control products in any application and corner of the world. They are in skyscrapers or windfarms, in offshore platforms or industrial areas which power the world. Approved by local and international standards. We believe in the strength of our brand and products - which is supported by our global service network to ensure your peace of mind.

- Latest approvals supports your installation complies to your local standards
- The product can be used in all installations in the world
- Giving you the confidence of world-wide sourcing – no matter where you build, install or operate your equipment



Reliable in harsh conditions

Our engineers thrive on the challenge to develop products that need to operate in the most difficult electrical, mechanical and environmental conditions. Our solutions protect your application from overloads, network irregularities, mechanical wear, and environmental stresses ensuring your peace of mind. When you buy an ABB product, you buy extensive **environmental testing guarantee.**

- High immunity against electromagnetic disturbances due to advanced measuring technology
- Operation in environment with high vibrations



Improve installation efficiency

In everything we do, we think of the customer and the application first. Our engineers constantly look for ways to simplify the installation process by developing innovative product designs which facilitate the product assembly and avoid mounting errors. ABB product can improve our customers' productivity and machinery quality.

- Simplified wiring even in case of different cable diameters
- Easy to adjust via front-face potentiometer
- Tool-free mounting and demounting
- Tool free installation due to push-in technology

Liquid level monitors and controls

Operating controls

CM-ENS.1x

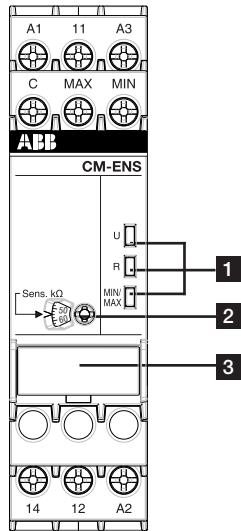

1 Indication of operational states with LEDs

U: green LED - Status indication of control supply voltage
 control supply voltage applied

R: yellow LED - Status indication of the output relays
 energized

MIN/MAX: yellow LED - Status indication of the electrodes
 MIN and MAX wet
 MIN wet

2 Adjustment of the response sensitivity

R: yellow LED - relay status
 U: green LED - control supply voltage

3 Marker label

CM-ENS.2x

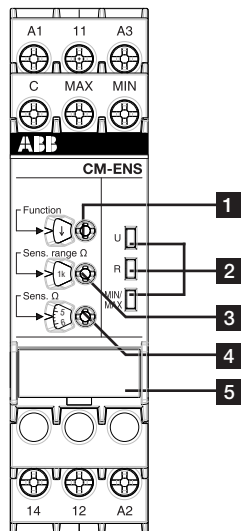

1 Adjustment of the function

↑ Fill
 ↓ Drain

2 Indication of operational states

U: green LED - Status indication of control supply voltage
 control supply voltage applied

R: yellow LED - Status indication of the output relays
 energized

MIN/MAX: yellow LED - Status indication of the electrodes
 MIN and MAX wet
 MIN wet

3 Adjustment of the response sensitivity range

4 Adjustment of the response sensitivity

5 Marker label

CM-ENS.31

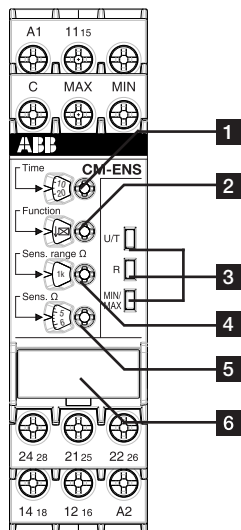

1 Adjustment of the time delay

2 Adjustment of the function

↑ ON-delayed Fill
 ↓ ON-delayed Drain
 ↑ OFF-delayed Fill
 ↓ OFF-delayed Drain

3 Indication of operational states

U: green LED - Status indication of control supply voltage
 control supply voltage applied
 time delay is running

R: yellow LED - Status indication of the output relays
 energized

MIN/MAX: yellow LED - Status indication of the electrodes
 MIN and MAX wet
 MIN wet

4 Adjustment of the response sensitivity range

5 Adjustment of the response sensitivity

6 Marker label

Liquid level monitors and controls

Selection

2

	1SVR 550 855 R9500	1SVR 550 850 R9500	1SVR 550 851 R9500	1SVR 550 855 R9400	1SVR 550 850 R9400	1SVR 550 851 R9400	1SVR 730 850 R0100	1SVR 740 850 R0100	1SVR 730 850 R2100	1SVR 740 850 R2100	1SVR 730 850 R0200	1SVR 740 850 R0200	1SVR 730 850 R2200	1SVR 740 850 R2200	1SVR 730 850 R0300	1SVR 740 850 R0300
	CM-ENE MIN	CM-ENE MIN	CM-ENE MIN	CM-ENE MAX	CM-ENE MAX	CM-ENE MAX	CM-ENS.11S	CM-ENS.11P	CM-ENS.13S	CM-ENS.13P	CM-ENS.21S	CM-ENS.21P	CM-ENS.23S	CM-ENS.23P	CM-ENS.31S	CM-ENS.31P
24-240 V AC/DC							■	■			■	■			■	■
24 V AC	■			■												
110-130 V AC		■			■				■	■			■	■		
220-240 V AC			■			■			■	■			■	■		
Number of electrodes (including ground reference)	2	2	2	2	2	2	3	3	3	3	3	3	3	3	3	3
0-100 kOhm	■	■	■	■	■	■										
5-100 kOhm							adj	adj	adj	adj						
0.1-1000 kOhm											adj	adj	adj	adj	adj	adj
Dry running protection	■	■	■				■	■	■	■	■	■	■	■	■	■
Overflow protection				■	■	■	■	■	■	■	■	■	■	■	■	■
Liquid level control				■	■	■	■	■	■	■	■	■	■	■	■	■
Open-circuit principle	■	■	■				■	■	■	■						
Closed-circuit principle				■	■	■										
Open- or closed-circuit principle											sel	sel	sel	sel	sel	sel
0.1-10 s															■	■
n/o	1	1	1	1	1	1										
c/o (SPTD)							1	1	1	1	1	1	1	1	2	2
Push-in terminals							■	■	■	■	■	■	■	■	■	■
Double-chamber cage connection terminals							■	■	■	■	■	■	■	■	■	■

adj: adjustable
sel: selectable

Liquid level monitors and controls

Ordering details



CM-ENE MIN

1SVR 550 851 R9500



CM-ENS.3x

2CDC 251 004 V0015



Bar electrode

1SVR 450 056 F6000



Suspension electrode

1SVC 110 000 F0478

Description

The liquid level monitoring relay CM-ENS monitors and controls the liquid level and ratios of mixtures of conductive fluids. It is used for filling and draining applications, to protect pumps against dry-running, tanks against overflow and for signalization of the status of the monitored liquid level.

Liquid level monitoring relays are

Suitable for		Not suitable for	
spring water	acids, bases	chemically pure water	ethylene glycol
drinking water	liquid fertilizers	fuel	concentrated alcohol
sea water	milk, beer, coffee	oils	paraffin
sewage	non-concentrated alcohol	explosive areas (liquid gas)	lacquers

Ordering details

Characteristics	Type	Order code	Price	Weight
			1 pce	(1 pce) kg (lb)
See "Selection" on page 181.	CM-ENE MIN	1SVR550855R9500		0.15 (0.33)
		1SVR550850R9500		0.15 (0.33)
		1SVR550851R9500		0.15 (0.33)
	CM-ENE MAX	1SVR550855R9400		0.15 (0.33)
		1SVR550850R9400		0.15 (0.33)
		1SVR550851R9400		0.15 (0.33)

Ordering details

Characteristics	Type	Order code	Price	Weight
			1 pce	(1 pce) kg (lb)
See "Selection" on page 181.	CM-ENS.11S	1SVR730850R0100		0.124 (0.273)
	CM-ENS.11P	1SVR730850R2100		0.117 (0.258)
	CM-ENS.13S	1SVR740850R0100		0.153 (0.337)
	CM-ENS.13P	1SVR740850R2100		0.145 (0.320)
	CM-ENS.21S	1SVR730850R0200		0.125 (0.276)
	CM-ENS.21P	1SVR740850R0200		0.117 (0.258)
	CM-ENS.23S	1SVR730850R2200		0.154 (0.340)
	CM-ENS.23P	1SVR740850R2200		0.147 (0.324)
	CM-ENS.31S	1SVR730850R0300		0.143 (0.315)
	CM-ENS.31P	1SVR740850R0300		0.134 (0.295)

S: screw connection
P: push-in connection

Ordering details - Bar electrodes

Description	Material no.	Type	Order code	Price	Weight
				1 pce	(1 pce) kg (lb)
Compact support for 3 bar electrodes	-	CM-KH-3	1SVR450056R6000		0.06 (0.132)
Distance plate for 3 bar electrodes	-	CM-AH-3	1SVR450056R7000		0.06 (0.132)
Counter nut for 1" thread	-	CM-GM-1	1SVR450056R8000		0.06 (0.132)
Length: 300 mm	1.4301	CM-SE-300	1SVR450056R0000		0.08 (0.176)
Length: 600 mm	1.4301	CM-SE-600	1SVR450056R0100		0.08 (0.176)
Length: 1000 mm	1.4301	CM-SE-1000	1SVR450056R0200		0.08 (0.176)

Ordering details - Suspension electrodes

Description	Material no.	Type	Order code	Price	Weight
				1 pce	(1 pce) kg (lb)
CM-HE suspension electrode	1.4104	CM-HE	1SVR402902R0000		0.074 (0.163)
CM-HC suspension electrode	1.4104	CM-HC	1SVR402902R1000		0.09 (0.198)
CM-HCT suspension electrode suitable for drink water	1.4301	CM-HCT	1SVR402902R2000		0.09 (0.198)



Further documentation liquid level monitoring relays on www.abb.com

Liquid level monitors and controls

Function diagrams

CM-ENS

2

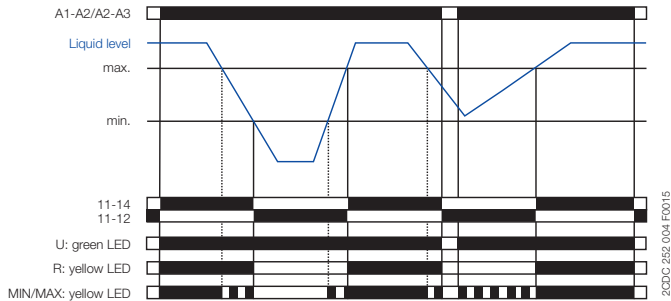

Drain: CM-ENS.1x, CM-ENS.2x

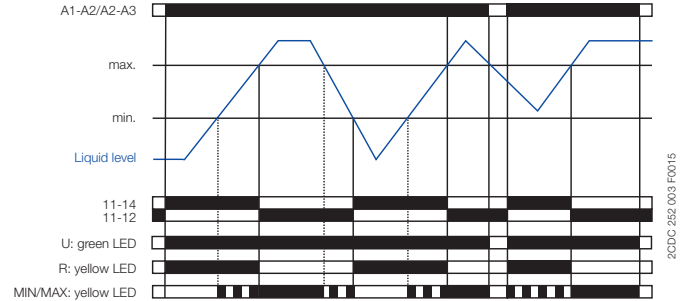

Fill: CM-ENS.2x

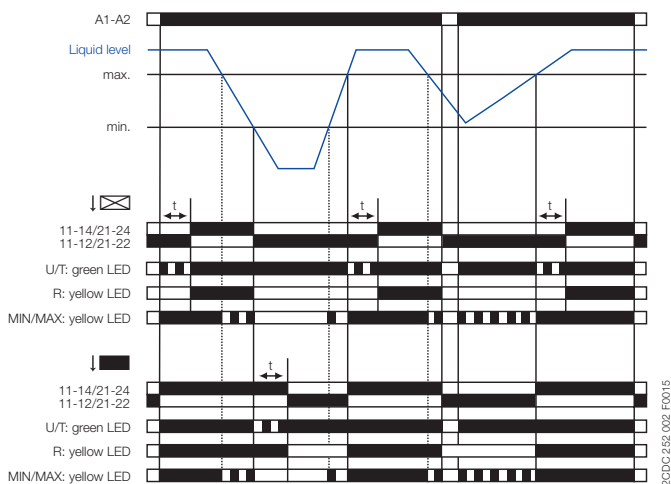

Drain: CM-ENS.31

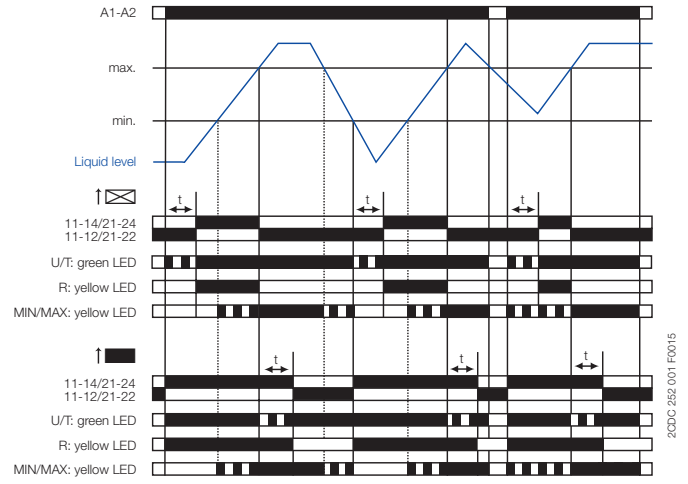

Fill: CM-ENS.31

CM-ENE MIN

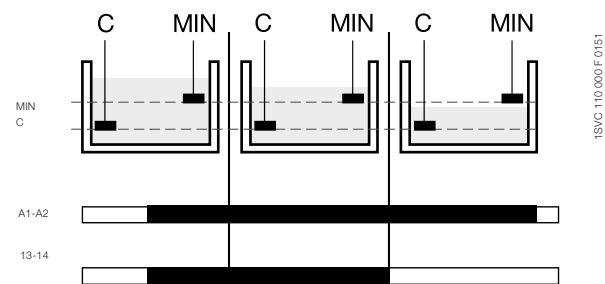

CM-ENE MAX

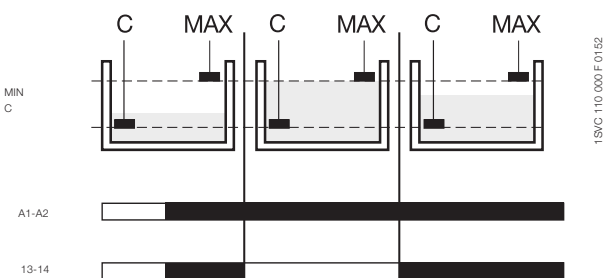

The liquid level relays CM-ENE MIN and CM-ENE MAX are used to monitor levels of conductive liquids, for example in pump control systems for dry-running or overflow monitoring.

The measuring principle is based on the occurring resistance change when moistening single-pole electrodes. The single-pole electrodes (see also section Accessories) are connected to the terminals C and MIN or MAX.

If the supply voltage is applied to A1-A2 and the electrodes are wet, the output relay of the CM-ENE MIN is energized and the output relay of the CM-ENE MAX is de-energized.

The output relay of the CM-ENE MIN de-energizes if the electrodes are no longer wet. The output relay of the CM-ENE MAX energizes if the electrodes are no longer wet.

Liquid level monitors and controls

Connection diagrams

CM-ENS.11, CM-ENS.21

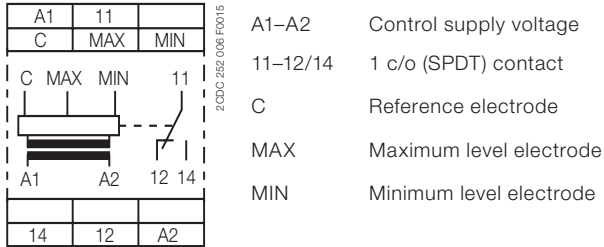

CM-ENS.13, CM-ENS.23

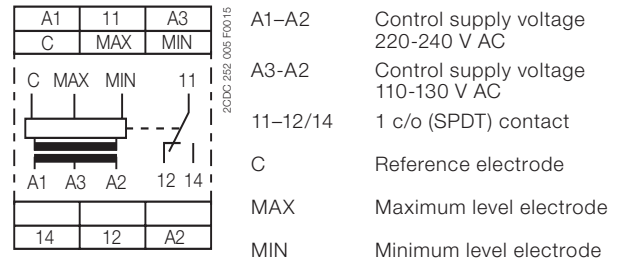

CM-ENS.31

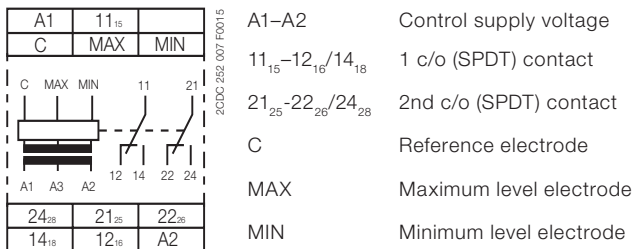

CM-ENE MIN

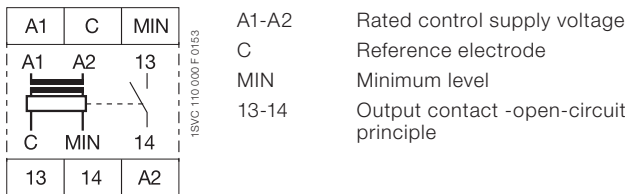

CM-ENE MAX

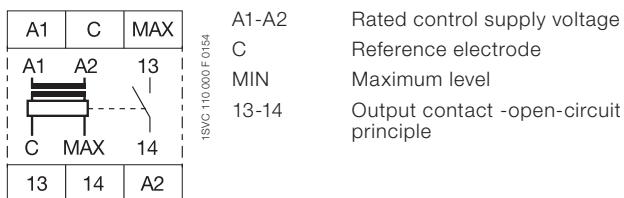

Liquid level monitors and controls

Cascading of several devices, application examples

Two devices in one tank

Several CM-ENS can be used in one tank. This extends the functionality with a pre-warning by two additional electrodes. In this way, two additional alarm outputs for exceeding or dropping below the normal level can be implemented in addition to the filling levels MAX and MIN.

2

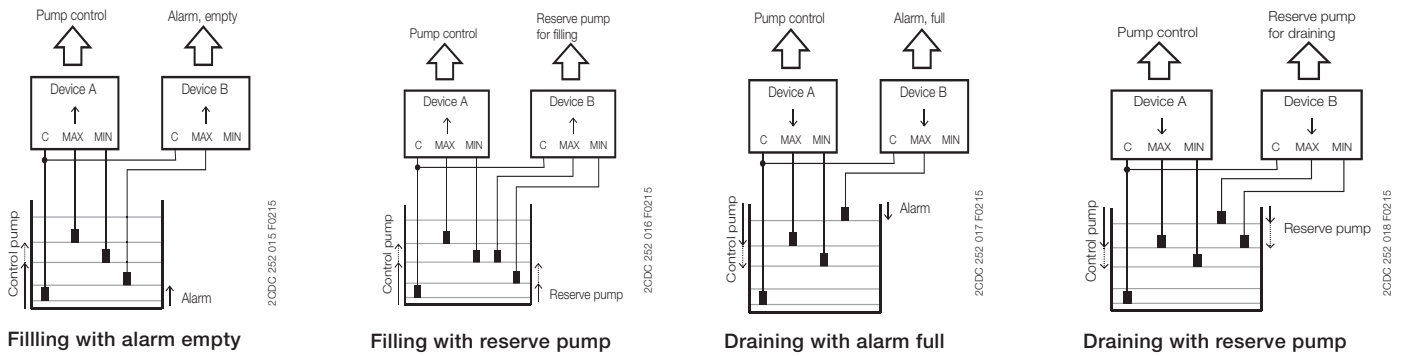

Application examples

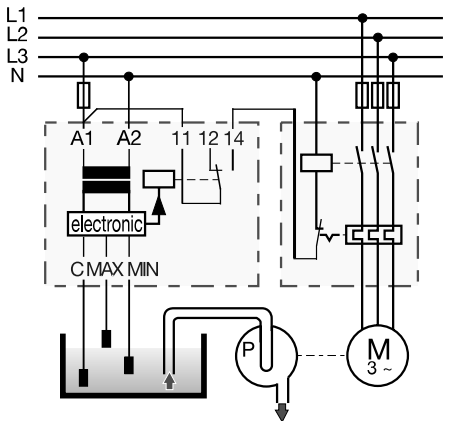

CM-ENS.1x
Liquid level control - drain

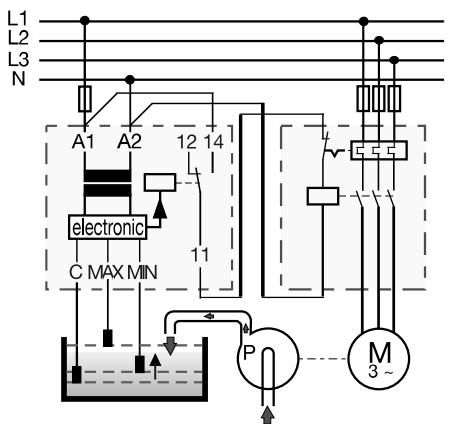

CM-ENS.2x, CM-ENS.31
Liquid level control - fill - selected function "↑" (UP)

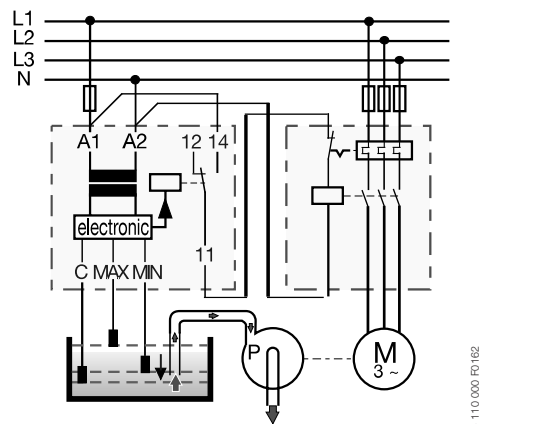

CM-ENS.2x, CM-ENS.31
Liquid level control - drain - selected function "↓" (Down)

Liquid level monitors and controls

Technical data - CM-ENE

Type		CM-ENE MIN	CM-ENE MAX
Supply circuit			
Rated control supply voltage U_s - power consumption	A1-A2	24 V AC	approx. 1.5 VA
	A1-A2	110-130 V AC	approx. 1.2 VA
	A1-A2	220-240 V AC	approx. 1.4 VA
Rated control supply voltage U_s tolerance		-15...+15 %	
Rated frequency		50-60 Hz	
Duty time		100 %	
Measuring circuit			
Monitoring function		dry-running protection	overflow protection
Response sensitivity		0-100 k Ω , not adjustable	
Maximum electrode voltage		30 V AC	
Maximum electrode current		1.5 mA	
Electrode supply line	max. cable capacity	3 nF	
	max. cable length	30 m	
Timing circuit			
Time delay		-	
Tripping delay		fixed approx. 200 ms	
Indication of operational states			
Output relay energized		R: yellow LED	
Output circuits			
Kind of output		1 n/o contact	
Operational principle ¹⁾		open-circuit principle	closed-circuit principle
Contact material		AgCdO	
Rated operational voltage U_o (IEC/EN 60947-1)		250 V	
Minimum switching voltage / minimum switching current		- / -	
Maximum switching voltage		250 V	
Rated operational current I_o (IEC/EN 60947-5-1)	AC-12 (resistive) 230 V	4 A	
	AC-15 (inductive) 230 V	3 A	
	DC-12 (resistive) 24 V	4 A	
	DC-13 (inductive) 24 V	2 A	
AC rating (UL 508)	Utilization category (Control Circuit Rating Code)	B 300	
	max. rated operational voltage	300 V AC	
	max. continuous thermal current at B 300	5 A	
	max. making/breaking apparent power at B 300	3600/360 VA	
Mechanical lifetime		30 x 10 ⁶ switching cycles	
Electrical lifetime (AC-12, 230 V, 4 A)		0.3 x 10 ⁶ switching cycles	
Max. fuse rating to achieve short-circuit protection	n/c contact	-	
	n/o contact	10 A fast-acting	
General data			
Dimensions (W x H x D)		22.5 x 78 x 78.5 mm (0.89 x 3.07 x 3.09 in)	
Mounting position		any	
Degree of protection	enclosure / terminals	IP50 / IP20	
Ambient temperature range	operation / storage	-20...+60 °C / -40...+85 °C	
Mounting		DIN rail (IEC/EN 60715)	
Electrical connection			
Wire size	fine-strand with wire-end ferrule	2 x 0.75-1.5 mm ² (2 x 18-16 AWG)	
	fine-strand without wire-end ferrule	2 x 1-1.5 mm ² (2 x 18-16 AWG)	
	rigid	2 x 0.75-1.5 mm ² (2 x 18-16 AWG)	
Stripping length		10 mm (0.39 inch)	
Tightening torque		0.6-0.8 Nm	
Standards			
Product standard		IEC 255-6, EN 60255-6	
Low Voltage Directive		2006/95/EC	
EMC Directive		2004/108/EC	
Electromagnetic compatibility			
electrostatic discharge	IEC/EN 61000-4-2	Level 3 (6 kV / 8 kV)	EN 61000-6-2, EN 61000-6-4
radiated, radio-frequency, electromagnetic field	IEC/EN 61000-4-3	Level 3 (10 V/m)	
electrical fast transient / burst	IEC/EN 61000-4-4	Level 3 (2 kV / 5 kHz)	
surge	IEC/EN 61000-4-5	Level 4 (2 kV L-L)	
conducted disturbances, induced by radio-frequency fields	IEC/EN 61000-4-6	Level 3 (10 V)	
Resistance to vibration (IEC 68-2-6)		6 g	
Mechanical resistance (IEC 68-2-6)		10 g	
Isolation data			
Rat. insulation volt. betw. supply, meas. & output circuit (VDE 0110, IEC 60947)		250 V	
Rated impulse withstand voltage between all isolated circuits (VDE 0110, IEC 664)		4 kV / 1.2-50 μ s	
Test voltage between all isolated circuits		2.5 kV, 50 Hz, 1 min.	
Pollution category (VDE 0110, IEC 664, IEC 255-5)		3 / C	
Overvoltage category (VDE 0110, IEC 664, IEC 255-5)		III / C	
Environmental testing (IEC 68-2-30)		24 h cycle time, 55 °C, 93 % rel., 96 h	

¹⁾ Open-circuit principle: Output relay energizes if the measured value exceeds/drops below the adjusted threshold.
Closed-circuit principle: Output relay de-energizes if the measured value exceeds/drops below the adjusted threshold.

Liquid level monitors and controls

Technical data - CM-ENS

2

Type		CM-ENS.1x	CM-ENS.2x	CM-ENS.31	
Supply circuit					
Rated control supply voltage U_s	CM-ENS.11, CM-ENS.21, CM-ENS.31: A1-A2	24-240 V AC/DC			
	CM-ENS.13, CM-ENS.23: A1-A2	220-240 V AC			
	CM-ENS.13, CM-ENS.23: A3-A2	110-130 V AC			
Rated control supply voltage U_s tolerance		-15...+10 %			
Rated frequency		50-60 Hz			
Frequency range		47-63 Hz			
Typical current / power consumption	24 V AC	25 mA / 0.6 W	25 mA / 0.6 W	25 mA / 0.6 W	
	110-130 V AC	20 mA / 2.6 VA	20 mA / 2.6 VA	8 mA / 1.1 VA	
	220-240 V AC	8.5 mA / 2.1 VA	8.5 mA / 2.1 VA	10 mA / 2.4 VA	
	24-240 V AC/DC	11 mA / 2.6 VA	11 mA / 2.6 VA	11 mA / 2.6 VA	
Power failure buffering time	min.	20 ms			
Start-up time t_s	Range 5-100 k Ω	max. 1.3 s	-	-	
	Range 0.1-1 k Ω	-	max. 900 ms	-	
	Range 1-10 k Ω	-	max. 900 ms	-	
	Range 10-100 k Ω	-	max. 1.3 s	-	
	Range 100-1000 k Ω	-	max. 6.3 s	-	
Measuring circuit					
Sensor type		electrode			
Monitoring function		fill or drain	fill or drain, selectable		
Measuring principle		conductivity measurement			
Number of electrodes		3			
Response sensitivity		adjustable: 5-100 k Ω	adjustable: 0.1-1000 k Ω		
Maximum electrode voltage		6 V AC			
Maximum electrode current		1 mA	2 mA		
		max cable capacity	max cable length	max cable capacity	max cable length
Electrode supply line	Range 5-100 k Ω	10 nF	100 m	-	-
	Range 0.1-1 k Ω	-	-	200 nF	1000 m
	Range 1-10 k Ω	-	-	200 nF	1000 m
	Range 10-100 k Ω	-	-	20 nF	100 m
	Range 100-1000 k Ω	-	-	4 nF	20 m
Max. measuring cycle	Range 5-100 k Ω	1000 ms	-	-	-
	Range 0.1-1 k Ω	-	-	700 ms	-
	Range 1-10 k Ω	-	-	700 ms	-
	Range 10-100 k Ω	-	-	1.1 s	-
	Range 100-1000 k Ω	-	-	5 s	-
Timing circuit					
Time delay		-	-	0.1-30 s, adjustable, ON- or OFF-delay	
Indication of operational states					
Control supply voltage		U: green LED			
Output relay energized		R: Yellow LED			
Electrode / alarm status		MAX/MIN: Yellow LED			
Output circuits					
Kind of output	11 ₁₅ -12 ₁₆ /14 ₁₈	relay, 1 c/o (SPDT) contact		relay, 1st c/o (SPDT) contact	
	21 ₁₅ -22 ₁₆ /24 ₁₈	-		relay, 2nd c/o (SPDT) contact	
Operational principle		open-circuit principle	open- or closed-circuit principle (selectable)		
Contact material		AgNi alloy, Cd free			
Rated operational voltage U_o	IEC/EN 60947-1	250 V AC			
Minimum switching voltage / minimum switching current		12 V / 10 mA			
Maximum switching voltage / Maximum switching current		see data sheets			
Rated operational current I_o (IEC/EN 60947-5-1)	AC-12 (resistive) 230 V	4 A			
	AC-15 (inductive) 230 V	3 A			
	DC-12 (resistive) 24 V	4 A			
	DC-13 (inductive) 24 V	2 A			
AC rating (UL 508)	Utilization category (Control Circuit Rating Code)	B 300, pilot duty general purpose (250 V, 4 A, $\cos \varphi$ 0.75)			
	max. rated operational voltage	300 V AC			
	max. continuous thermal current at B 300	5 A			
	max. making/breaking apparent power at B 300	3600/360 VA			
Mechanical lifetime		10 x 10 ⁶ switching cycles			
Electrical lifetime (AC-12, 230 V, 4 A)		0.1 x 10 ⁶ switching cycles			
Max. fuse rating to achieve short-circuit protection	n/c / n/o contact	6 A / 10 A fast-acting		10 A / 10 A fast-acting	
Conventional thermal current I_{th} acc. IEC/EN 60947-1		4 A			

Liquid level monitors and controls

Technical data - CM-ENS

2

Type		CM-ENS.1x	CM-ENS.2x	CM-ENS.31
General data				
MTBF		on request		
Duty time		100 %		
Dimensions (W x H x D)	product dimensions	22.5 x 85.6 x 103.7 mm (0.89 x 3.37 x 4.08 in)		
	packaging dimensions	30 x 97 x 109 mm (1.18 x 3.82 x 4.29 in)		
Weight		see „Ordering details“ on page <?>		
Mounting position		any		
Minimum distance to other units		CM-ENS.x1: not necessary CM-ENS.x3: 10 mm if contact current > 2 A		
Degree of protection	housing / terminals	IP50 / IP20		
Material of housing		UL 94 V-0		
Mounting		DIN rail (IEC/EN 60715), snap-on mounting without any tool		
Electrical connection				
Wire size	fine-strand with(out) wire end ferrule	Screw connection technology 1 x 0.5-2.5 mm ² (1 x 20-14 AWG) 2 x 0.5-1.5 mm ² (2 x 20-16 AWG)	Easy Connect Technology (push-in) 2 x 0.5-1.5 mm ² (2 x 20-16 AWG)	
	rigid	1 x 0.5-4 mm ² (1 x 20-12 AWG) 2 x 0.5-2.5 mm ² (2 x 20-14 AWG)	2 x 0.5-1.5 mm ² (2 x 20-16 AWG)	
Stripping length		8 mm (0.32 in)		
Tightening torque		0.6 - 0.8 Nm (5.31 - 7.08 lb.in)	-	
Standards				
Product standard		IEC/EN 60255-1		
Other standards		EN 50178, IEC/EN 60204		
Low Voltage Directive		2006/95/EC		
RoHS Directive		2011/65/EC		
EMC Directive		2004/108/EC		
Environmental data				
Ambient temperature ranges	operation	-25...+60 °C		
	storage	-40...+85 °C		
Damp heat, cyclic (IEC/EN 60068-2-30)		6 x 24 h cycle, 55 °C, 95 % RH		
Climatic category (IEC/EN 60721-3-3)		3K5 (no condensation, no ice formation)		
Vibration, sinusoidal (IEC/EN 60255-21-1)		Class 2		
Shock (IEC/EN 60255-21-2)		Class 2		
Isolation data				
Rated impulse withstand voltage	supply circuit / measuring circuit	4 kV		
U _{imp} between all isolated circuits (IEC/EN 60947-1, IEC/EN 60664-1)	supply circuit / output circuits	4 kV		
	measuring circuit / output circuits	4 kV		
	output circuit 1 / output circuit 2	4 kV		
Pollution degree (IEC/EN 60664-1)		3		
Overvoltage category (IEC/EN 60664-1)		III		
Rated insulation voltage U _i (IEC/EN 60947-1, IEC/EN 60664-1)	supply circuit / measuring circuit	300 V		
	supply circuit / output circuits	300 V		
	measuring circuit / output circuits	300 V		
	output circuit 1 / output circuit 2	300 V		
Basis isolation for rated control supply voltage (IEC/EN 60664-1)	supply circuit / measuring circuit	250 V AC / 300 V DC		
	supply circuit / output circuits	250 V AC / 300 V DC		
	measuring circuit / output circuits	250 V AC / 300 V DC		
	output circuit 1 / output circuit 2	250 V AC / 300 V DC		
Protective separation (IEC/EN 61140, EN 50178)	supply circuit / measuring circuit	250 V AC / 300 V DC		
	supply circuit / output circuits	250 V AC / 300 V DC		
	measuring circuit / output circuits	250 V AC / 300 V DC		
	supply circuit / measuring circuit	2.0 kV, 50 Hz, 1 s		
Test voltage between all isolated circuits, routine test (IEC/EN 60255-5)	supply circuit / output circuits	2.0 kV, 50 Hz, 1 s		
	measuring circuit / output circuits	2.0 kV, 50 Hz, 1 s		
	supply circuit / measuring circuit	2.0 kV, 50 Hz, 1 s		
Test voltage between all isolated circuits, type test (IEC/EN 60255-5)	supply circuit / output circuits	2.0 kV, 50 Hz, 1 s		
	measuring circuit / output circuits	2.0 kV, 50 Hz, 1 s		
Electromagnetic compatibility				
Interference immunity to		EN 61000-6-1, EN 61000-6-2, EN60255-26		
electrostatic discharge	IEC/EN 61000-4-2	Level 3 (6 kV / 8 kV)		
	IEC/EN 61000-4-3	Level 3 (10 V/m)		
radiated, radio-frequency, electromagnetic field	IEC/EN 61000-4-4	Level 3, 2 kV / 5 kHz		
	IEC/EN 61000-4-5	Level 3, installation class 3, supply circuit and measuring circuit 1 kV L-L, 2 kV L-earth		
electrical fast transient / burst surge		Level 3, 10 V		
conducted disturbances, induced by radio-frequency fields	IEC/EN 61000-4-6	Level 3, 10 V		
	IEC/EN 61000-4-11	Class 3		
voltage dips, short interruptions and voltage variations	IEC/EN 61000-4-11	Class 3		
	IEC/EN 61000-4-11	Class 3		
Interference emission				
high-frequency radiated	IEC/CISPR 22, EN 55022	IEC/EN 61000-6-3, IEC/EN 61000-6-4		
high-frequency conducted	IEC/CISPR 22, EN 55022	CM-ENS.x1: Class A, CM-ENS.x3: Class B		
		CM-ENS.x1: Class A, CM-ENS.x3: Class B		

General technical data, Accessories, Current transformers

Technical diagrams - CM-range

Load limit curves

CM-S (22.5 mm), CM-E (22.5 mm), CM-UFD.M22

AC load (resistive)

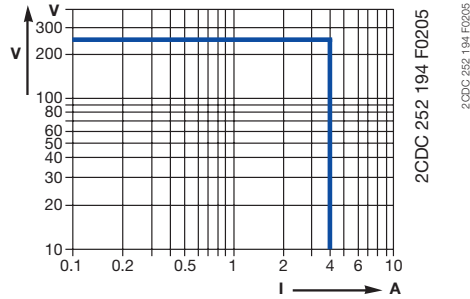

DC load (resistive)

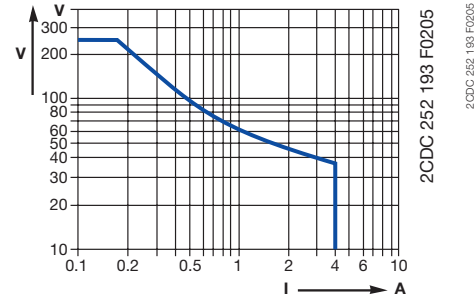

Derating factor F for inductive AC load

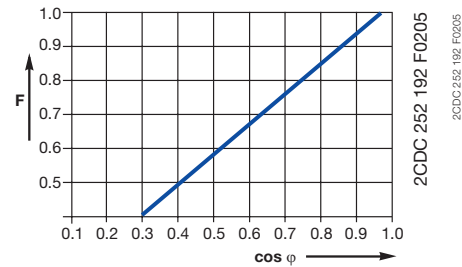

Contact lifetime

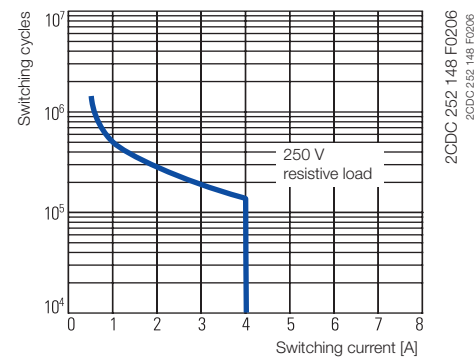

CM-N (45 mm)

AC load (resistive)

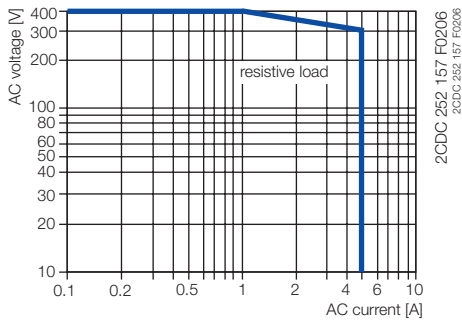

DC load (resistive)

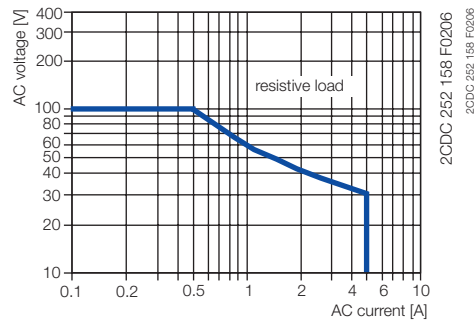

Derating factor F for inductive AC load

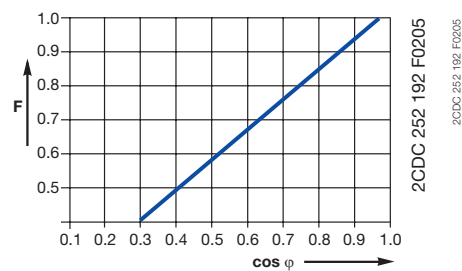

Contact lifetime

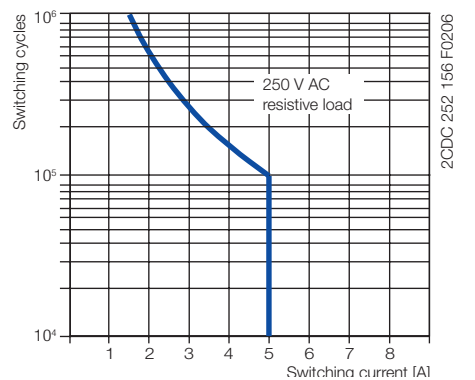

General technical data, Accessories, Current transformers

Technical diagrams - CM-range

Load limit curves CM-UFD.M21

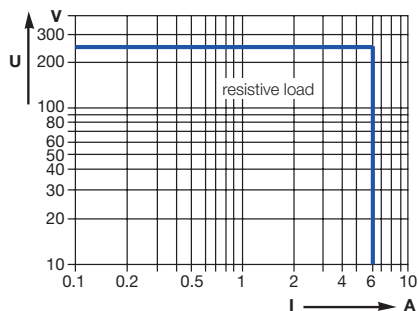

2CDC 252 010 F0212

AC load (resistive)

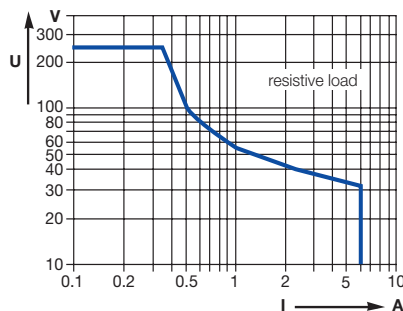

2CDC 252 011 F0212

DC load (resistive)

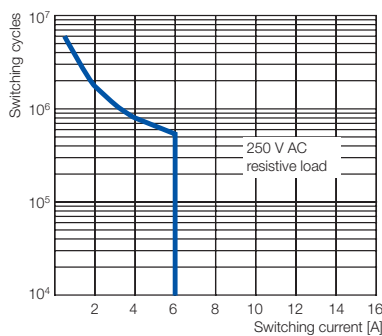

2CDC 252 012 F0212

Contact lifetime

General technical data, Accessories, Current transformers

Dimensional drawings

Measuring and monitoring relays CM range old housing

Dimensions in mm

2

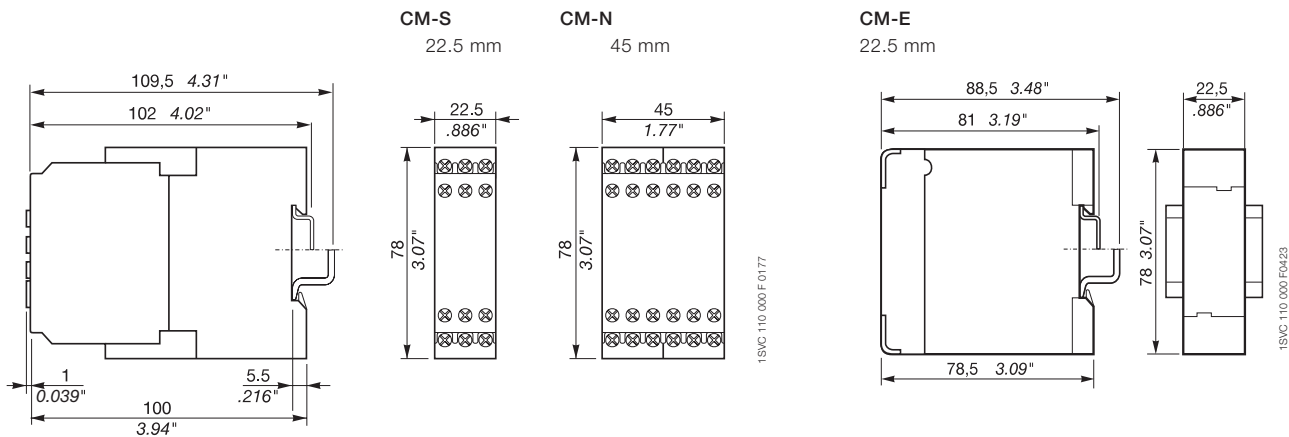

Measuring and monitoring relays CM range new housing

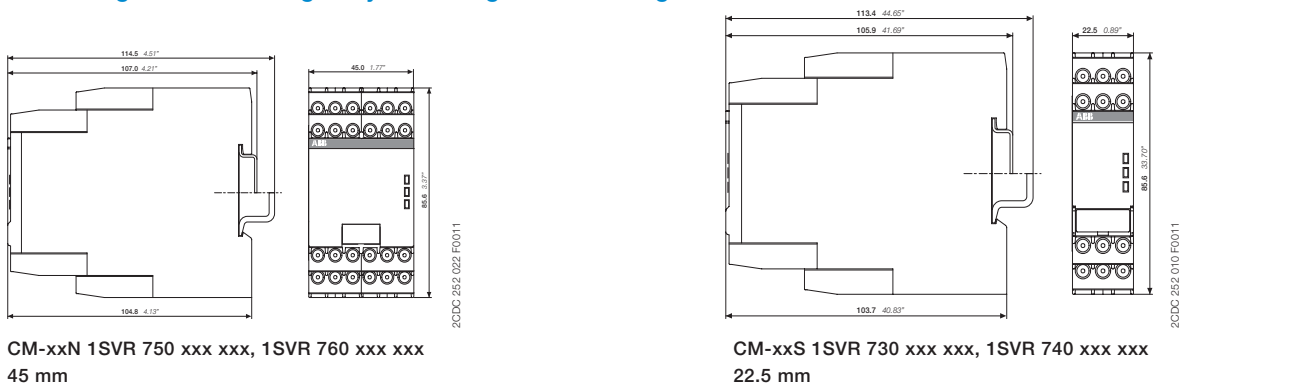

CM-xxN 1SVR 750 xxx xxx, 1SVR 760 xxx xxx
45 mm

CM-xxS 1SVR 730 xxx xxx, 1SVR 740 xxx xxx
22.5 mm

Temperature monitoring relays

Dimensional drawing CM-UFD.Mxx

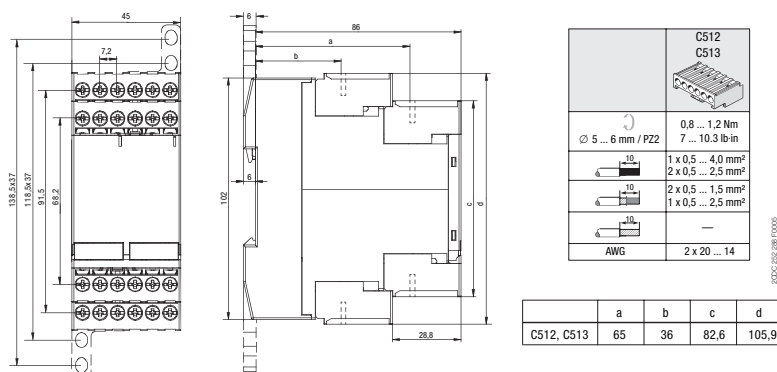

C512/C513
45 mm

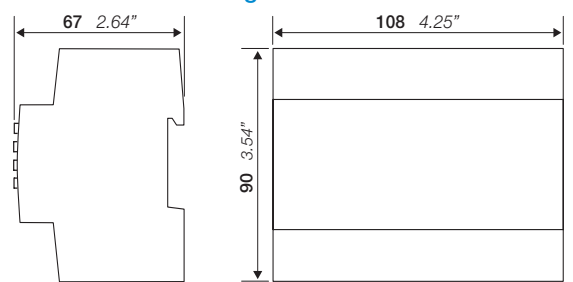

2CDC 252 008 F0013

General technical data, Accessories, Current transformers

Ordering details - CM-range accessories

Accessories

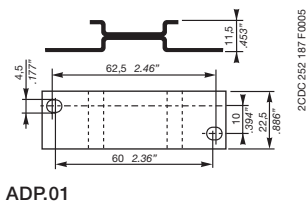

ADP.01

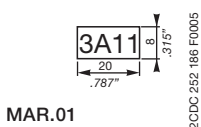

MAR.01

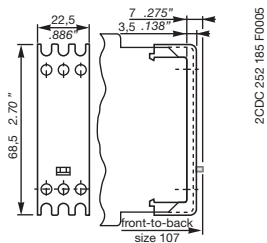

Sealable cover
COV.01

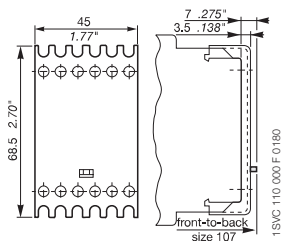

Sealable cover
COV.02

Ordering details

Description	For type	Width in mm	for devices	Type	Order code	Price pce	Pkg qty	Weight (1 pce) g (oz)
Adapter for screw mounting	CM-S CM-S.S/P	22.5		ADP.01	1SVR430029R0100		1	18.4 (0.65)
	CM-N CM-N.S/P	45		ADP.02	1SVR440029R0100		1	36.7 (1.30)
Marker label	CM-S, CM-N CM-S.S/P CM-N.S/P		without DIP switches	MAR.01	1SVR366017R0100		10	0.19 (0.007)
	CM-S, CM-N		with DIP switches	MAR.02	1SVR430043R0000		10	0.13 (0.005)
	CM-S.S/P CM-N.S/P		with DIP switches	MAR.12	1SVR730006R0000		10	0.152 (0.335)
Sealable transparent cover	CM-S	22.5		COV.01	1SVR430005R0100		1	5.2 (0.18)
	CM-N	45		COV.02	1SVR440005R0100		1	7.7 (0.27)
	CM-S.S/P	22.5		COV.11	1SVR730005R0100		1	4.0 (0.129)
	CM-N.S/P	45		COV.12	1SVR750005R0100		1	7 (0.247)

General technical data, Accessories, Current transformers

Ordering details - CM-CT current transformers

2

2CDC 251 002 F0005



CM-CT

2CDC 251 003 F0005



CM-CT with mounted accessories

2CDC 251 159 F0006



CM-CT-A mounted on DIN rail

Plug-in current transformers CM-CT

- Without primary conductor though with foot angle, insulating protective cap and bar fastening screws
- Primary / rated current from 50 A to 600 A
- Secondary current of 1 A or 5 A
- Class 1

Ordering details

Rated primary current	Secondary current	Burden class	Type	Order code	Price pce	Weight (1 pce) g (oz)
50 A	1 A	1 VA / 1	CM-CT 50/1	1SVR450116R1000		0.31 (0.683)
75 A		1.5 VA / 1	CM-CT 75/1	1SVR450116R1100		0.31 (0.683)
100 A		2.5 VA / 1	CM-CT 100/1	1SVR450116R1200		0.276 (0.608)
150 A		2.5 VA / 1	CM-CT 150/1	1SVR450116R1300		0.32 (0.705)
200 A		2.5 VA / 1	CM-CT 200/1	1SVR450116R1400		0.222 (0.489)
300 A		5 VA / 1	CM-CT 300/1	1SVR450117R1100		0.29 (0.639)
400 A	5 A	5 VA / 1	CM-CT 400/1	1SVR450117R1200		0.27 (0.595)
500 A		5 VA / 1	CM-CT 500/1	1SVR450117R1300		0.29 (0.639)
600 A		5 VA / 1	CM-CT 600/1	1SVR450117R1400		0.24 (0.529)
50 A		1 VA / 1	CM-CT 50/5	1SVR450116R5000		0.3 (0.661)
75 A		1.5 VA / 1	CM-CT 75/5	1SVR450116R5100		0.31 (0.683)
100 A		2.5 VA / 1	CM-CT 100/5	1SVR450116R5200		0.31 (0.683)
150 A	5 A	2.5 VA / 1	CM-CT 150/5	1SVR450116R5300		0.28 (0.617)
200 A		5 VA / 1	CM-CT 200/5	1SVR450116R5400		0.29 (0.639)
300 A		5 VA / 1	CM-CT 300/5	1SVR450117R5100		0.252 (0.556)
400 A		5 VA / 1	CM-CT 400/5	1SVR450117R5200		0.26 (0.573)
500 A		5 VA / 1	CM-CT 500/5	1SVR450117R5300		0.208 (0.459)
600 A		5 VA / 1	CM-CT 600/5	1SVR450117R5400		0.21 (0.463)

Ordering details - Accessories

Description	Type	Order code	Price 10 pces	Weight (1 pce) g (oz)
Snap-on fastener for DIN rail mounting of CM-CT	CM-CT A	1SVR450118R1000		0.009 (0.02)

Operating principle / circuit diagram

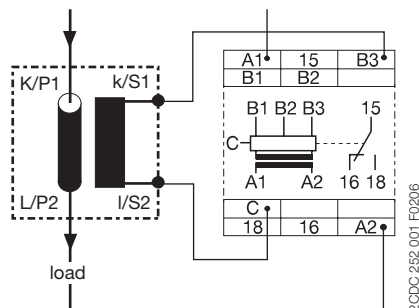

Dimensional drawing

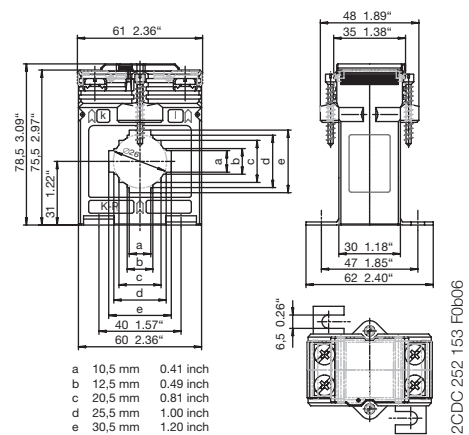

General technical data, Accessories, Current transformers

Notes

Primary switch mode power supplies

Product group picture

3



Primary switch mode power supplies

Table of contents

Primary switch mode power supplies

Primary switch mode power supplies	180
Table of contents	180
Overview	181
Approvals and marks	182
Selection table - Single-phase	183
Selection table - Three-phase	184
CP-D range	186
Table of contents	186
Ordering details	188
Technical data	189
Technical diagrams	193
Dimensional drawings	194
CP-E range	196
Table of contents	196
Benefits and advantages	197
Ordering details	198
Technical data	199
Technical diagrams, Wiring instructions	207
Technical diagrams, Dimensional drawings	208
CP-T range	210
Table of contents	210
Benefits and advantages	211
Ordering details	212
Technical data	213
Technical diagrams, Dimensional drawings	217
Technical diagrams	218
CP-C.1 range	220
Benefits and advantages	221
Ordering details	222
Technical data	223
Technical diagrams	226
Technical diagrams, Dimensional drawings	227
Technical diagrams	228
Redundancy units	229
Ordering details	229
Technical data	230
Dimensional drawings	234
CP-B range	236
Table of contents	236
Benefits and advantages	237
Ordering details	238
Technical data	239
Technical data, Technical diagrams	240
Dimensional drawings	241
Electronic protection devices EPD24	244
Table of contents	244
Ordering details	245
Technical data	246
Technical information	248
Approvals, Safety instructions	249
Installation guidelines	250

Primary switch mode power supplies

Overview

Modern power supply units are a vital component in most areas of energy management and automation technology. ABB as your global partner in these areas pays the utmost attention to the resulting requirements. Innovation is the key to a substantial enlargement of our power supply product program:

CP-D range Distribution panel design



- Output voltages 12 and 24 V DC
- Output currents 0.42, 0.83, 1.3, 2.1, 2.5, 4.2 A
- Power range 10, 30, 60, 100 W
- Wide range input
- 100-240 V AC (90-264 V AC, 120-375 V DC)
- High efficiency of up to 89 %
- Low power dissipation and low heating
- Heights of only 91 mm (3.583 in)
- Distribution panel design

CP-E range up to 100 W Economy range



- Rated output voltages 5, 12, 24 V DC, adjustable
- Output currents from 0.625 up to 10 A
- Power range from 15 up to 60 W
- High efficiency of up to 90 %
- Low power dissipation and low heating
- Wide ambient temperature range from -40 to +70 °C

CP-E above 100 W Economy range CP-T Three-phase range



- Rated output voltages 12, 24, 48 V DC, adjustable
- Output currents 5, 10, 20, 40 A
- Power range
- CP-E 120, 240, 480 W
- CP-T: 120, 240, 480, 960 W
- High efficiency up to 90% (CP-E) / 93% (CP-T)
- Low power dissipation and low heating
- Wide ambient temperature range from -40 to +70 °C

CP-C.1 range High-performance range



- Rated output voltage 24 V DC, adjustable
- Output current 5 A, 10 A and 20 A
- Typical efficiency of up to 94 %
- Power reserve design delivers up to 150 % of the nominal output current
- Signaling outputs for DC OK and power reserve mode
- High power density leads to very compact and small devices











CP-B range Short time buffers



- Ultra cap based buffer modules for short time UPS systems
- Rated input voltage 24 V DC
- Rated currents 3, 10, 20 A
- Expandable with CP-B EXT.2 module
- LEDs for status indication
- High efficiency, higher than 90%
- Signaling and status outputs
- Buffer times at 100% load current from 13 s to 38 s (depending on device)

Primary switch mode power supplies

Approvals and marks

		CP-D	CP-E	CP-T	CP-C.1 ¹⁾	CP-B	Redundancy units
	UL 508, CAN/CSA C22.2 No.107.1	All	All	All		All	-
	UL 1310, CAN/CSA C22.2 No.223 (Class 2 Power Supply)	All except: CP-D 24/4.2	All except: CP-E 12/10.0, CP-E 24/5.0, CP-E 24/10.0, CP-E 24/20.0, CP-E 48/5.0, CP-E 48/10.0	-		-	-
	UL 60950, CAN/CSA C22.2 No.60950	All	All	All		-	All except CP-D RU
	ANSI/ISA-12.12 (Class I, Div. 2, hazardous locations) CAN/CSA C22.2 No. 213	-	All	All		-	-
	CB Scheme	All	-	-		-	All except CP-D RU
	EAC	All	All	All		All	All except CP-D RU
	CCC	All	All	-		-	-
	GB4943, GB9254, GB17625.1	-	-	All		-	-
	Communauté Européenne	All	All	All		All	All
	RCM	All	All	All		-	Available CP-A RU, CP-D RU Pending CP-A CM

¹⁾ CP-C.1 approvals pending

Primary switch mode power supplies

Selection table - Single-phase

		Single-phase																					
		CP-D					CP-E							CP-C.1									
		1SVR427041R1000	1SVR427043R1200	1SVR427041R0000	1SVR427043R0100	1SVR427044R0200	1SVR427045R0400	1SVR427033R3000	1SVR427032R1000	1SVR427035R1000	1SVR427030R0000	1SVR427031R0000	1SVR427032R0000	1SVR427034R0000	1SVR427035R0000	1SVR427036R0000	1SVR427030R2000	1SVR427031R2000	1SVR427034R0000	1SVR427035R2000	1SVR360663R1001	1SVR360663R1001	1SVR360763R1001
Rated output voltage	5 V DC							■															
	12 V DC	■	■						■	■													
	24 V DC			■	■	■	■				■	■	■	■	■						■	■	■
	48 V DC																■	■	■	■			
Rated output current	0.42 A			■																			
	0.625 A																■						
	0.75 A										■												
	0.83 A	■																					
	1.25 A											■							■				
	1.3 A				■																		
	2.1 A		■																				
	2.5 A					■			■				■										
	3 A							■														■	
	4.2 A						■																
	5 A													■						■			
	10 A									■					■						■		■
	20 A										■					■							■
Rated output power	10 W	■		■																			
	15 W							■															
	18 W											■											
	30 W		■		■				■			■					■						
	60 W					■					■							■					
	100 W						■												■				
	120 W									■				■						■		■	
	480 W														■					■			■
Rated input voltage	100 - 240 V AC	■	■	■	■	■	■	■	■	■	■	■	■	■	■	■	■	■	■	■			
	115/230 V AC auto select									■				■	■								
	115 - 230 V AC															■				■			
	110 - 240 V AC																				■	■	■
	220 - 240 V AC																						
DC input voltage range	120 - 370 V DC	■	■	■	■	■	■	■		■					■					■			
	90 - 375 V DC								■		■	■				■		■					
	210 - 370 V DC									■				■	■					■			
	90 - 300 V DC																				■	■	■
Features	Power reserve design																				■	■	■
	Adjustable output voltage		■		■	■	■	■	■	■	■	■	■	■	■	■	■	■	■	■	■	■	■
	Integrated input fuse	■	■	■	■	■	■	■	■	■	■	■	■	■	■	■	■	■	■	■	■	■	■
	Short circuit stable	■	■	■	■	■	■	■	■	■	■	■	■	■	■	■	■	■	■	■	■	■	■
	Fold forward behavior (U/I)	■	■	■	■	■	■		■	■	■	■	■	■	■	■	■	■	■	■	■	■	■
	Fold back behavior (hiccup)							■			■												
	Power factor correction									pas				pas	pas	act			pas	act		■	■
	Ambient temp. rating -25°C (-40°C) to 70°C	■	■	■	■	■	■	■	■	■	■	■	■	■	■	■	■	■	■	■	■		
	Parallel connection							■	■	3	■	■	■	3	3	3	■	■	3	3	5	5	5
	Serial connection	■	■	■	■	■	■	■	■	2	■	■	■	2	2	2	■	■	2	2	2	2	2

Primary switch mode power supplies

Selection table - Three-phase

		Order number	1SVR427054R0000	1SVR427055R0000	1SVR427056R0000	1SVR427057R0000	1SVR427054R2000	1SVR427055R2000	1SVR427056R2000	
		Three-phase								
		CP-T								
Rated output voltage	24 V DC	■	■	■	■					
	30.5 V DC									
	48 V DC						■	■	■	
Rated output current	2.8 A									
	3 A									
	5 A	■					■			
	8 A									
	10 A		■					■		
	20 A			■						■
	40 A				■					
Rated output power	85 W									
	120 W	■								
	122 W									
	240 W		■				■			
	244 W									
	480 W			■				■		
960 W				■					■	
Rated input voltage	85-132 V AC, 184-264 V AC									
	3 x 400 - 800 V AC	■	■	■	■	■	■	■	■	
DC input voltage range	18-32.4 V DC									
	480 - 820 V DC	■	■	■	■	■	■	■	■	
Features	Adjustable output voltage	■	■	■	■	■	■	■	■	
	Integrated input fuse	■	■	■	■	■	■	■	■	
	Short circuit stable	■	■	■	■	■	■	■	■	
	Fold forward behavior (U/I)	■	■	■	■	■	■	■	■	
	Fold back behavior (hiccup)	■	■	■	■	■	■	■	■	
	Power factor correction									
	Ambient temp. rating -25°C (-40°C) to 70°C	■	■	■	■	■	■	■	■	
	Serial connection		2	2	2	2	2	2	2	
	Suited for AS-Interfaces									

CP-D range

Product group picture

3



CP-D range

Table of contents

CP-D range

CP-D range	186
Table of contents	186
Ordering details	188
Technical data	189
Technical diagrams	193
Dimensional drawings	194

CP-D range

Benefits and advantages

Characteristics

- Output voltages 12 V, 24 V DC
- Adjustable output voltages (devices > 10 W)
- Output currents 0.42 A / 0.83 A / 1.3 A / 2.1 A / 2.5 A / 4.2 A
- Power range 10 W, 30 W, 60 W, 100 W
- Wide range input 100-240 V AC (90-264 V AC, 120-375 V DC)
- High efficiency of up to 89 %
- Low power dissipation and low heating
- Free convection cooling (no forced cooling with ventilators)
- Ambient temperature range during operation -40 °C...+70 °C
- Open-circuit, overload and short-circuit stable
- Integrated input fuse
- U/I characteristic (fold-forward behaviour at overload – no switch-off)
- LEDs for status indication
- Light-grey housing in RAL 7035
- Approvals / Marks (depending on device, partly pending):



Benefits

Width and structural form ①

With their width between 18 to 90 mm only, the CP-D range switch mode power supplies are ideally suited for installation in distribution panels.

Wide range input ②

Optimised for world-wide applications: The CP-D power supplies can be supplied with 90-264 V AC or 120-375 V DC.

Adjustable output voltage ③

The CP-D range types > 10 W feature a continuously adjustable output voltage. Thus, they can be optimally adapted to the application, e.g. compensating the voltage drop caused by a long line length.

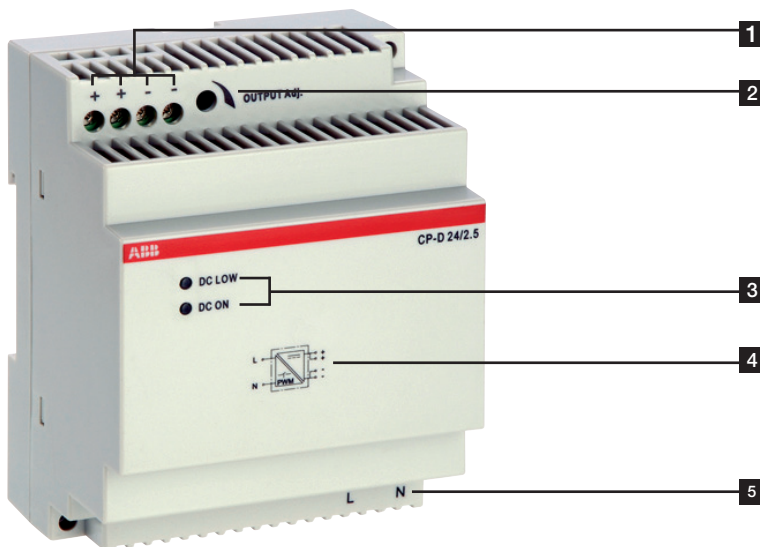
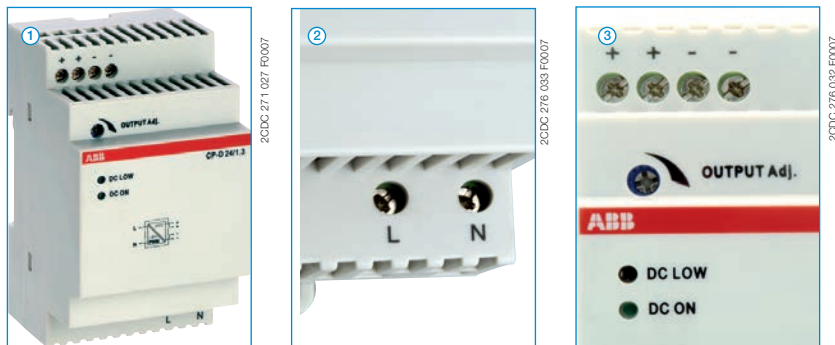

- 1** OUTPUT ++/--: terminals - output
- 2** OUTPUT Adjust: potentiometer - adjustment of output voltage
- 3** Indication of operational states
DC ON: green LED - output voltage applied
DC LOW: red LED - output voltage too low
- 4** Circuit diagram
- 5** INPUT L, N: terminals - input

CP-D range

Ordering details



CP-D 12/0.83, CP-D 24/0.42



CP-D 12/2.1, CP-D 24/1.3



CP-D 24/2.5

Description

The CP-D range of modular power supply units in MDRC design (modular DIN rail components) is ideally suited for installation in distribution panels. This range offers devices with output voltages of 12 V DC and 24 V DC at output currents of 0.42 A to 4.2 A. Thanks to a high thermal efficiency corresponding to low power and heat dissipation, the devices can be operated without forced cooling. All devices feature the U/I output characteristic (fold forward behaviour). All power supply units in the CP-D range are approved according to all relevant international standards.

Ordering details

Input voltage range	Rated output voltage / current	Type	Order code	Price 1 pce	Weight (1 pce) kg (lb)
90-264 V AC/ 120-375 V DC	12 V DC / 0.83 A	CP-D 12/0.83	1SVR427041R1000		0.06 (0.13)
90-264 V AC/ 120-375 V DC	12 V DC / 2.1 A	CP-D 12/2.1	1SVR427043R1200		0.19 (0.41)
90-264 V AC/ 120-375 V DC	24 V DC / 0.42 A	CP-D 24/0.42	1SVR427041R0000		0.06 (0.13)
90-264 V AC/ 120-375 V DC	24 V DC / 1.3 A	CP-D 24/1.3	1SVR427043R0100		0.19 (0.41)
90-264 V AC/ 120-375 V DC	24 V DC / 2.5 A	CP-D 24/2.5	1SVR427044R0200		0.25 (0.56)
90-264 V AC/ 120-375 V DC	24 V DC / 4.2 A	CP-D 24/4.2	1SVR427045R0400		0.32 (0.71)



Further documentation CP-D power supplies on www.abb.com

CP-D range

Technical data

Data at $T_a = 25\text{ °C}$, $U_{in} = 230\text{ V AC}$ and rated values, unless otherwise indicated

Type	CP-D 12/0.83	CP-D 12/2.1
Input circuit - supply circuit		
	L, N	
Rated input voltage U_{in}	100-240 V AC	
Input voltage range	90-264 V AC / 120-375 V DC	
Frequency range AC	47-63 Hz	
Typical input current / typical power consumption	at 110 V AC	200 mA / 12.68 W
	at 230 V AC	128.3 mA / 13.01 W
Inrush current limiting	at 110 V AC	502 mA / 31.14 W
	at 230 V AC	277 mA / 31.2 W
Power failure buffering time	30 A (max. 3 ms)	
Internal input fuse	50 A (max. 3 ms)	
Power factor correction (PFC)	min. 30 ms	
	1 A slow-acting / 250 V AC	
	2 A slow-acting / 250 V AC	
	no	
Indication of operational states		
Output voltage	DC ON: green LED	□: output voltage applied
	DC LOW: red LED	□: output voltage too low
Output circuit		
	+, -	++, --
Rated output voltage	12 V DC	
Tolerance of the output voltage	±1 %	
Adjustment range of the output voltage	-	
Rated output power	12-14 V DC	
Rated output current I_r	10 W	
	25 W	
Derating of the output current	$T_a \leq 60\text{ °C}$	0.83 A
	$60\text{ °C} < T_a \leq 70\text{ °C}$	2.1 A
Maximum deviation with change of output voltage within the input voltage range	load change statical	max. 1 %
		max. 1 %
Control time	< 1 ms	
Starting time after applying the supply voltage	at I_r 1000 ms	
Rise time	at rated load typ. 1 ms	
Residual ripple and switching peaks	BW = 20 MHz 50 mV	
Parallel connection	yes, using CP-D RU	
Series connection	yes, to increase voltage	
Resistance to reverse feed	18 V / 1 s	
Output circuit - No-load, overload and short-circuit behaviour		
Characteristic curve of output	U/I characteristic curve	
Short-circuit protection	continuous short-circuit stability	
Short-circuit behaviour	continuation with output power limiting	
Current limiting at short circuit	typ. 1.4 A	typ. 5.9 A
Overload protection	output power limiting	
Overvoltage protection	15-16.5 V DC	
No-load protection	continuous no-load stability	
Starting of capacitive loads	unlimited	
General data		
Efficiency	typ. 78 %	typ. 82 %
Duty time	100 %	
Dimensions (W x H x D)	18 x 91 x 57.5 mm (0.71 x 3.58 x 2.26 in)	53 x 91 x 57.5 mm (2.09 x 3.58 x 2.26 in)
Weight	0.066 kg (0.13 lb)	0.196 kg (0.41 lb)
Material of housing	plastic	
Mounting	DIN rail (IEC/EN 60715), snap-on mounting without any tool	
Mounting position	horizontal	
Minimum distance to other units	horizontal / vertical	25 mm / 25 mm (0.98 in / 0.98 in)
Degree of protection	housing / terminals	IP20 / IP20
Protection class	II	

CP-D range

Technical data

Data at $T_a = 25\text{ °C}$, $U_n = 230\text{ V AC}$ and rated values, unless otherwise indicated

Type		CP-D 12/0.83	CP-D 12/2.1
Electrical connection - Input circuit / Output circuit			
Wire size	fine-strand with wire end ferrule	0.2-1.5 mm ² (24-16 AWG)	0.2-2.5 mm ² (24-14 AWG)
	rigid	0.2-2.5 mm ² (26-12 AWG)	0.2-2.5 mm ² (24-12 AWG)
Stripping length		4-5 mm (0.16-0.2 in)	7 mm (0.28 in)
Tightening torque		0.6 Nm (5 lb.in)	0.7 Nm (6 lb.in)
Environmental data			
Ambient temperature range	operation	-40...+70 °C	
	rated load	-40...+60 °C	
	storage	-40...+85 °C	
Damp heat (cyclic) (IEC/EN 60068-2-30)		4 x 24 cycles, 40 °C, 95 % RH	
Vibration (sinusoidal) (IEC/EN 60068-2-6)		50 m/s ² , 10 Hz - 2 kHz	
Shock (half-sine) (IEC/EN 60068-2-27)		40 m/s ² , 22 ms	
Isolation data			
Rated insulation voltage U_i	input circuit / output circuit	3 kV AC	
Pollution degree		2	
Overvoltage category (UL/IEC/EN 60950-1)		II	
Standards			
Product standard		EN 61204	
Low Voltage Directive		2006/95/EC	
EMC Directive		2004/108/EC	
Electrical safety		UL 508, UL 60950-1, EN 60950-1	
Protective low voltage		SELV (EN 60950-1)	
Electromagnetic compatibility			
Interference immunity to		EN 61000-6-2	
electrostatic discharge	IEC/EN 61000-4-2	Level 4 (4 kV / 8 kV)	Level 4 (4 kV / 15 kV)
radiated, radio-frequency, electromagnetic field	IEC/EN 61000-4-3	Level 3 (10 V/m)	
electrical fast transient/burst	IEC/EN 61000-4-4	Level 4 (4 kV)	
surge	IEC/EN 61000-4-5	Level 3 (2 kV L-L)	
conducted disturbances, induced by radio-frequency fields	IEC/EN 61000-4-6	Level 3 (10 V)	
Interference emission		EN 61000-6-3	
high-frequency radiated	IEC/CISPR 22, EN 55022	Class B	
high-frequency conducted	IEC/CISPR 22, EN 55022	Class B	

"Approvals and marks" on page 182

CP-D range

Technical data

Data at $T_a = 25\text{ °C}$, $U_{in} = 230\text{ V AC}$ and rated values, unless otherwise indicated

Type	CP-D 24/0.42	CP-D 24/1.3	CP-D 24/2.5	CP-D 24/4.2	
Input circuit - supply circuit	L, N				
Rated input voltage U_{in}	100-240 V AC				
Input voltage range	90-264 V AC / 120-375 V DC				
Frequency range AC	47-63 Hz				
Typical input current / typical power consumption	at 110 V AC	184 mA / 11.62 W	600 mA / 37.92 W	1120 mA / 69.3 W	1800 mA / 117.3 W
	at 230 V AC	120.6 mA / 12 W	344 mA / 38.16 W	660 mA / 70.1 W	900 mA / 114.4 W
Inrush current limiting	at 230 V AC 30 A (max. 3 ms) 50 A (max. 3 ms) 60 A (max. 3 ms)				
Power failure buffering time	min. 30 ms		min. 60 ms		
Internal input fuse	1 A slow-acting / 250 V AC	2 A slow-acting / 250 V AC		3.15 A slow-acting / 250 V AC	
Power factor correction (PFC)	no				
Indication of operational states					
Output voltage	DC ON: green LED	[]: output voltage applied			
	DC LOW: red LED	[]: output voltage too low			
Output circuit	+, -		++, --		
Rated output voltage	24 V DC				
Tolerance of the output voltage	±1 %				
Adjustment range of the output voltage	-				
Rated output power	10 W	30 W	60 W	100 W	
Rated output current I_r	$T_a \leq 60\text{ °C}$: 0.42 A	$T_a \leq 60\text{ °C}$: 1.3 A	$T_a \leq 55\text{ °C}$: 2.5 A	$T_a \leq 60\text{ °C}$: 4.2 A	
Derating of the output current	$60\text{ °C} < T_a \leq 70\text{ °C}$: 2.5 %/°C	$60\text{ °C} < T_a \leq 70\text{ °C}$: 2.5 %/°C	$55\text{ °C} < T_a \leq 70\text{ °C}$: 2.5 %/°C	$60\text{ °C} < T_a \leq 70\text{ °C}$: 2.5 %/°C	
Maximum deviation with load change stactical change of output voltage within the input voltage range	max. 1 %				
Control time	< 1 ms				
Starting time after applying the supply voltage	at I_r 1000 ms				
Rise time	at rated load typ. 1 ms				
Residual ripple and switching peaks	BW = 20 MHz 50 mV				
Parallel connection	yes, using CP-D RU				
Series connection	yes, to increase voltage				
Resistance to reverse feed	35 V / 1 s				
Output circuit - No-load, overload and short-circuit behaviour					
Characteristic curve of output	U/I characteristic curve				
Short-circuit protection	continuous short-circuit stability				
Short-circuit behaviour	continuation with output power limiting				
Current limiting at short circuit	typ. 0.78 A	typ. 4.2 A	typ. 6.05 A	typ. 11.5 A	
Overload protection	output power limiting				
Overvoltage protection	30-33 V DC				
No-load protection	continuous no-load stability				
Starting of capacitive loads	unlimited				
General data					
Efficiency	typ. 80 %	typ. 83 %	typ. 86 %	typ. 89 %	
Duty time	100 %				
Dimensions (W x H x D)	18 x 91 x 57.5 mm (0.71 x 3.58 x 2.26 in)	53 x 91 x 57.5 mm (2.09 x 3.58 x 2.26 in)	71 x 91 x 57.5 mm (2.80 x 3.58 x 2.26 in)	89.9 x 91 x 57.5 mm (3.54 x 3.58 x 2.26 in)	
Weight	0.066 kg (0.13 lb)	0.196 kg (0.41 lb)	0.252 kg (0.55 lb)	0.386 kg / (0.72 lb)	
Material of housing	plastic				
Mounting	DIN rail (IEC/EN 60715), snap-on mounting without any tool				
Mounting position	horizontal				
Minimum distance to other units	horizontal / vertical 25 mm / 25 mm (0.98 in / 0.98 in)				
Degree of protection	housing / terminals IP20 / IP20				
Protection class	II				

CP-D range

Technical data

Data at $T_a = 25\text{ °C}$, $U_n = 230\text{ V AC}$ and rated values, unless otherwise indicated

Type		CP-D 24/0.42	CP-D 24/1.3	CP-D 24/2.5	CP-D 24/4.2
Electrical connection - Input circuit / Output circuit					
Wire size	fine-strand with wire end ferrule	0.2-1.5 mm ² (24-16 AWG)	0.2-2.5 mm ² (24-14 AWG)		
	rigid	0.2-2.5 mm ² (26-12 AWG)	0.2-2.5 mm ² (24-12 AWG)		
Stripping length		4-5 mm (0.16-0.2 in)		7 mm (0.28 in)	
Tightening torque		0.6 Nm (5 lb.in)		0.7 Nm (6 lb.in)	
Environmental data					
Ambient temperature range	operation	-40...+70 °C			
	rated load	-40...+60 °C		-40...+55 °C	-40...+60 °C
	storage	-40...+85 °C			
Damp heat (cyclic) (IEC/EN 60068-2-30)		4 x 24 cycles, 40 °C, 95 % RH			
Vibration (sinusoidal) (IEC/EN 60068-2-6)		50 m/s ² , 10 Hz - 2 kHz			
Shock (half-sine) (IEC/EN 60068-2-27)		40 m/s ² , 22 ms			
Isolation data					
Rated insulation voltage U_i	input circuit / output circuit	3 kV AC		4 kV AC	3 kV AC
Pollution degree		2			
Overvoltage category (UL/IEC/EN 60950-1)		II			
Standards					
Product standard		EN 61204			
Low Voltage Directive		2006/95/EC			
EMC Directive		2004/108/EC			
Electrical safety		UL 508, UL 60950-1, EN 60950-1			
Protective low voltage		SELV (EN 60950-1)			
Electromagnetic compatibility					
Interference immunity to electrostatic discharge		EN 61000-6-2			
	IEC/EN 61000-4-2	Level 4 (4 kV / 8 kV)	Level 4 (4 kV / 15 kV)	Level 4 (4 kV / 8 kV)	
radiated, radio-frequency, electromagnetic field	IEC/EN 61000-4-3	Level 3 (10 V/m)			
electrical fast transient/burst	IEC/EN 61000-4-4	Level 4 (4 kV)			
surge	IEC/EN 61000-4-5	Level 3 (2 kV L-L)			
conducted disturbances, induced by radio-frequency fields	IEC/EN 61000-4-6	Level 3 (10 V)			
Interference emission		EN 61000-6-3			
high-frequency radiated	IEC/CISPR 22, EN 55022	Class B			
high-frequency conducted	IEC/CISPR 22, EN 55022	Class B			

"Approvals and marks" on page 182

CP-D range

Technical diagrams

3

Characteristic curve of output at $T_a = 25\text{ }^\circ\text{C}$

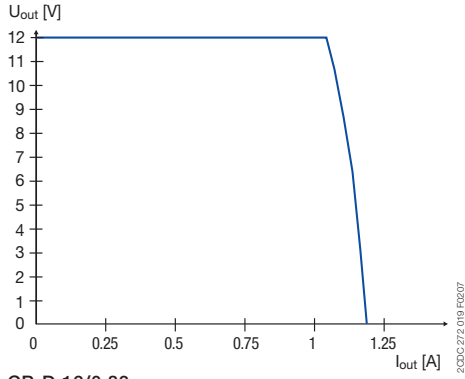

CP-D 12/0.83

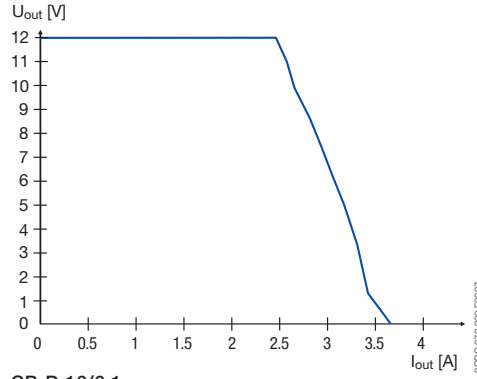

CP-D 12/2.1

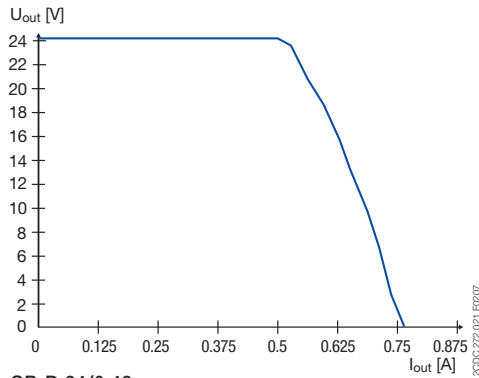

CP-D 24/0.42

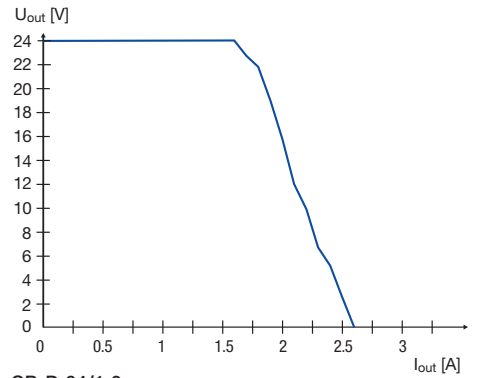

CP-D 24/1.3

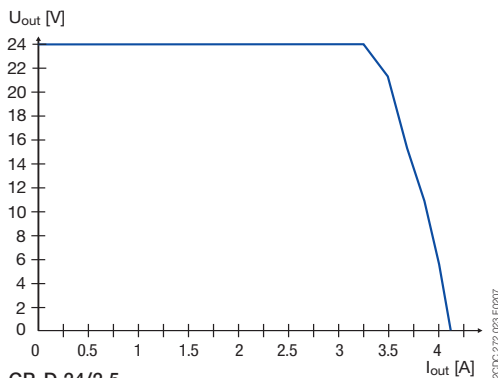

CP-D 24/2.5

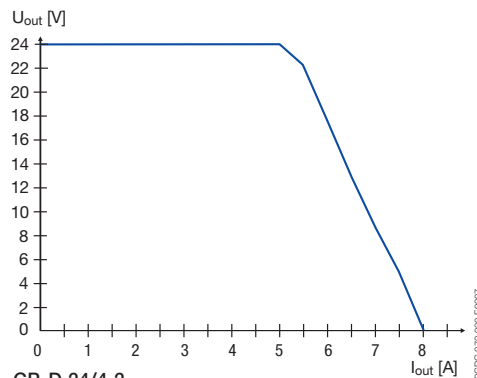

CP-D 24/4.2

Characteristic curve of temperature at rated output voltage

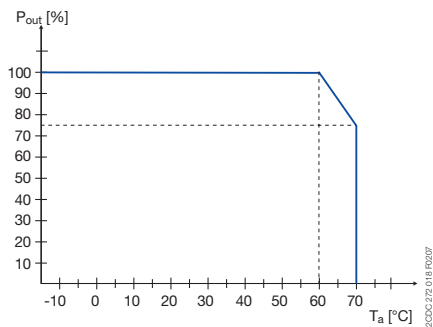

CP-D except CP-D 24/2.5

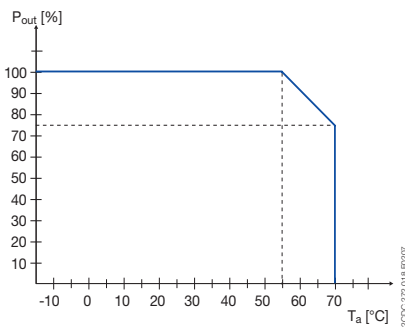

CP-D 24/2.5

CP-D range

Dimensional drawings

Dimensional drawings dimensions in mm

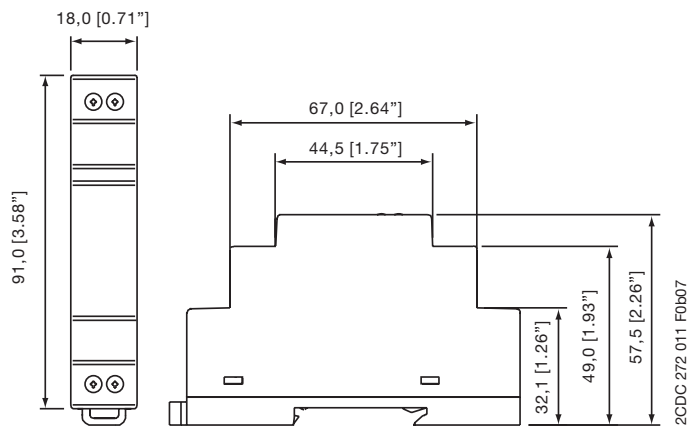

CP-D 12/0.83, CP-D 24/0.42

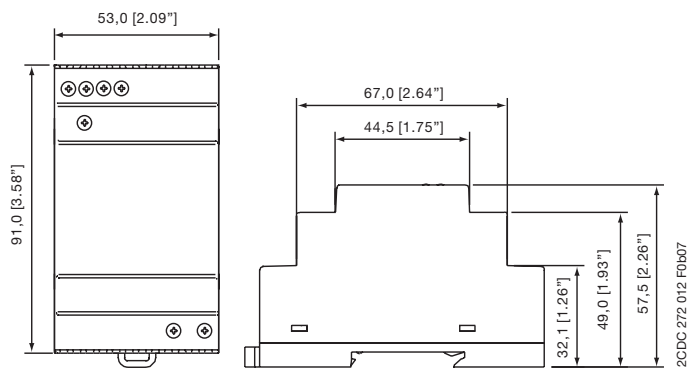

CP-D 12/2.1, CP-D 24/1.3

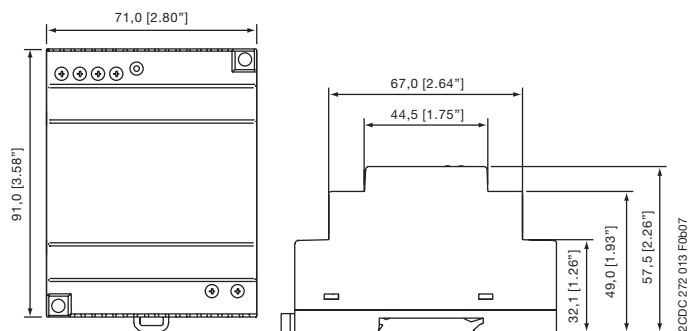

CP-D 24/2.5

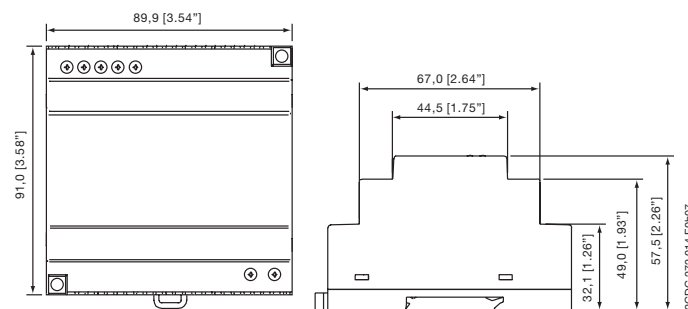

CP-D 24/4.2

CP-E range Product group picture

3



CP-E range

Table of contents

CP-E range

CP-E range	196
Table of contents	196
Benefits and advantages	197
Ordering details	198
Technical data	199
Technical diagrams, Wiring instructions	207
Technical diagrams, Dimensional drawings	208

CP-E range

Benefits and advantages

3

Characteristics

- Output voltages 5 V, 12 V, 24 V, 48 V DC
- Adjustable output voltages
- Output currents 0.625 A / 0.75 A / 1.25 A / 2.5 A / 3 A / 5 A / 10 A / 20 A
- Power range 15 W, 18 W, 30 W, 60 W, 120 W, 240 W, 480 W
- High efficiency of up to 90 %
- Low power dissipation and low heating
- Free convection cooling (no forced cooling with ventilators)
- Ambient temperature range during operation -40...+70 °C
- Open-circuit, overload and short-circuit stable
- Integrated input fuse
- U/I characteristic curve on devices > 18 W (fold-forward behaviour at overload – no switch-off)
- Redundancy units offering true redundancy
- LED(s) for status indication
 - Signalling output/contact for output voltage OK
Transistor on 24 V devices > 18 W and < 120 W
 - Solid-state on 24 V devices \geq 120 W
- Approvals / Marks (depending on device, partly pending):
-

Benefits

Signalling output/contact ①

The CP-E range 24 V devices > 18 W offer an output/contact for monitoring of the output voltage and remote diagnosis.

Wide range input ②

Optimised for world-wide applications: The CP-E power supplies can be supplied within a wide range of AC or DC voltage.

Adjustable output voltage ③

The CP-E range types feature a continuously adjustable output voltage. Thus, they can be optimally adapted to the application, e.g. compensating the voltage drop caused by a long line length.

Redundancy units ④

For decoupling of parallelized power supply units \leq 40 V. Thus, true redundancy can be achieved. Further information about redundancy unit on page 229.

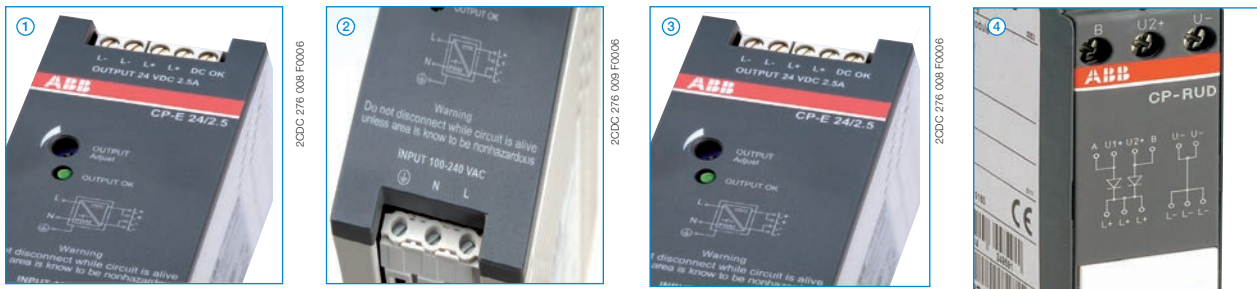

- 1** INPUT L, N, PE: terminals - input
- 2** Circuit diagram
- 3** single/parallel: sliding switch - adjustment of single or parallel operation
- 4** Indication of operational states
DC ON: green LED - green LED - output voltage OK
DC LOW: red LED - output voltage too low
- 5** OUTPUT L+, L+, L-, L-: terminals - output
- 6** OUTPUT Adjust: potentiometer - adjustment of output voltage

CP-E range

Ordering details



CP-E 12/2.5

2CDC271 013 F0008



CP-E 48/5.0

2CDC271 028 F0008

Description

This range offers types with output voltages from 5 V DC to 48 V DC at output currents of 0.625 A to 20 A. The high thermal efficiency of up to 90 %, corresponding to very low power and heat dissipation, allows operation without forced cooling. The functionality has been enhanced while the number of different types has been considerably reduced.

Of course all power supplies of the CP-E range are approved in accordance with all relevant international standards.

Ordering details - CP-E < 100 W

Input voltage range	Rated output voltage / current	Type	Order code	Price 1 pce	Weight (1 pce) kg (lb)
90-264 V AC / 120-375 V DC	5 V DC / 3 A	CP-E 5/3.0	1SVR427033R3000		0.15 (0.33)
85-264 V AC / 90-375 V DC	12 V DC / 2.5 A	CP-E 12/2.5	1SVR427032R1000		0.29 (0.64)
90-132 V AC, 180-264 V AC / 210-375 V DC	12 V DC / 10 A	CP-E 12/10.0	1SVR427035R1000		1.00 (2.20)
90-264 V AC / 120-375 V DC	24 V DC / 0.75 A	CP-E 24/0.75	1SVR427030R0000		0.15 (0.33)
85-264 V AC / 90-375 V DC	24 V DC / 1.25 A	CP-E 24/1.25	1SVR427031R0000		0.29 (0.64)
85-264 V AC / 90-375 V DC	24 V DC / 2.5 A	CP-E 24/2.5	1SVR427032R0000		0.36 (0.79)

Ordering details - CP-E ≥ 120 W

Input voltage range	Rated output voltage / current	Type	Order code	Price 1 pce	Weight (1 pce) kg (lb)
90-132 V AC, 180-264 V AC / 210-375 V DC	24 V DC / 5 A	CP-E 24/5.0	1SVR427034R0000		1.00 (2.20)
90-132 V AC, 180-264 V AC / 210-375 V DC	24 V DC / 10 A	CP-E 24/10.0	1SVR427035R0000		1.36 (3.01)
90-264 V AC / 120-375 V DC	24 V DC / 20 A	CP-E 24/20.0	1SVR427036R0000		1.90 (4.18)
85-264 V AC / 90-375 V DC	48 V DC / 0.625 A	CP-E 48/0.62	1SVR427030R2000		0.29 (0.64)
85-264 V AC / 90-375 V DC	48 V DC / 1.25 A	CP-E 48/1.25	1SVR427031R2000		0.36 (0.79)
90-132 V AC, 180-264 V AC / 210-375 V DC	48 V DC / 5 A	CP-E 48/5.0	1SVR427034R2000		1.36 (3.01)
90-264 V AC / 120-375 V DC	48 V DC / 10 A	CP-E 48/10.0	1SVR427035R2000		1.90 (4.19)



Further documentation CP-E power supplies on www.abb.com

CP-E range

Technical data

Data at $T_a = 25\text{ °C}$, $U_{in} = 230\text{ V AC}$ and rated values, unless otherwise indicated

Type		CP-E 5/3.0	CP-E 12/2.5	CP-E 12/10.0
Input circuit				
Rated input voltage U_{in}		100-240 V AC	L, N	
Input voltage range		90-264 V AC / 120-375 V DC	85-264 V AC / 90-375 V DC	115 / 230 V AC auto_select 90-132 V AC, 180-264 V AC / 210-375 V DC
Frequency range AC		47-63 Hz		
Typical input current	at 115 V AC	335 mA	560 mA	2.2 A
	at 230 V AC	210 mA	330 mA	0.83 A
Typical power consumption		19.8 W	35.9 W	143 W
Inrush current limiting	at 115 V AC	10 A (max. 3 ms)	20 A (max. 3 ms)	24 A (max. 5 ms)
	at 230 V AC	18 A (max. 3 ms)	40 A (max. 3 ms)	48 A (max. 5 ms)
Discharge current	input / output	0.25 mA		
	input / PE	3.5 mA		
Power failure buffering time	at 115 V AC	min. 20 ms	min. 20 ms	min. 25 ms
	at 230 V AC	min. 75 ms	min. 30 ms	min. 30 ms
Internal input fuse		2 A slow-acting / 250 V AC		3,15 A slow-acting / 250 V AC
Power factor correction (PFC)		no		yes, passive, 0.7
Indication of operational states				
Output voltage	green LED	OK: : output voltage OK	OUTPUT OK: : output voltage OK	OUTPUT OK: : output voltage OK
	red LED	LOW: : output voltage too low	-	OUTPUT LOW: : output voltage too low
Output circuit				
		L+,L-	L+, L+, L-, L-	
Rated output voltage		5 V DC	12 V DC	
Tolerance of the output voltage		0...+1 %		
Adjustment range of the output voltage		4.5-5.75 V DC	12-14 V DC	11.4-14.5 V DC
Rated output power		15 W	30 W	120 W
Rated output current I_r	$T_a \leq 60\text{ °C}$	3.0 A	2.5 A	10 A
Derating of the output current	$60\text{ °C} < T_a \leq 70\text{ °C}$	2.5 %/°C		
Maximum deviation with	load change statical	±2 %	±0.5 %	±1 % (single mode) ±5 % (parallel mode)
	change of output voltage within the input voltage range	±1 %	±0.5 %	±0.5 %
Control time		< 2 ms		
Starting time after applying the supply voltage	at I_r	max. 1 s		
	with 3500 µF	-	max. 2 s	-
	with 7000 µF	max. 1.5 s	-	max. 1.5 s
Rise time	at rated load	max. 150 ms		
	with 3500 µF	-	max. 500 ms	-
	with 7000 µF	max. 500 ms	-	max. 500 ms
Fall time		max. 150 ms		
Residual ripple and switching peaks	BW = 20 MHz	50 mV		
Parallel connection		yes, to enable redundancy		configurable, to increase power, up to 3 devices, min. 0.1 I_r - max. 0.9 I_r
Series connection		yes, to increase voltage		yes, to increase voltage, max. 2 devices
Resistance to reverse feed		1 s - max. 7.5 V DC	1 s - max. 18 V DC	max. 18 V DC
Output circuit - No-load, overload and short-circuit behaviour				
Characteristic curve of output		Hiccup-mode	U/I characteristic curve	
Short-circuit protection		continuous short-circuit proof		
Short-circuit behaviour		Hiccup-mode	continuation with output power limiting	
Overload protection		output power limiting		
No-load protection		continuous no-load stability		
Starting of capacitive loads		7000 µF	3500 µF	7000 µF

CP-E range

Technical data

Data at $T_a = 25\text{ °C}$, $U_{in} = 230\text{ V AC}$ and rated values, unless otherwise indicated



Type		CP-E 5/3.0	CP-E 12/2.5	CP-E 12/10.0
General data				
Power dissipation		typ. 5 W	typ. 5.6 W	typ. 24 W
Efficiency		typ. 75 %	typ. 84 %	typ. 84 %
Duty time		100 %		
Dimensions (W x H x D)		22.5 x 90 x 114 mm (0.89 x 3.54 x 4.49 in)	40.5 x 90 x 114 mm (1.59 x 3.54 x 4.49 in)	63.2 x 123.6 x 123.6 mm (2.49 x 4.87 x 4.87 in)
Weight		0.144 kg (0.317 lb)	0.287 kg (0.633 lb)	0.888 kg (1.958 lb)
Material of housing		Plastic		Metal
Mounting		DIN rail (IEC/EN 60715), snap-on mounting without any tool		
Mounting position		horizontal		
Minimum distance to other units	horizontal / vertical	25 mm / 25 mm (0.98 in / 0.98 in)		
Degree of protection	housing / terminals	IP20 / IP20		
Protection class		I		
Electrical connection - input circuit / output circuit				
Wire size	fine-strand with wire end ferrule	0.2-2.5 mm ² (24-14 AWG)		0.2-4 mm ² (24-11 AWG)
	fine-strand without wire end ferrule			0.2-6 mm ² (24-10 AWG)
	rigid			
Stripping length		6 mm (0.24 in)		8 mm (0.31 in)
Tightening torque	input / output	0.6 Nm (5 lb.in)		1.0 Nm (9 lb.in) / 0.62 Nm (5.5 lb.in)
Environmental data				
Ambient temperature range	operation	-20...+70 °C	-40...+70 °C	-35...+70 °C
	rated load	-20...+60 °C	-40...+60 °C	-35...+60 °C
	storage	-20...+85 °C	-40...+85 °C	-40...+85 °C
Damp heat (cyclic) (IEC/EN 60068-2-30)		95 RH, % without condensation		
Vibration (sinusoidal) (IEC/EN 60068-2-6)		10-500 Hz, 2 G, along X, Y, Z each axis, 60 min. for each axis		
Shock (half-sine) (IEC/EN 60068-2-27)		15 G, 11 ms, 3 axes, 6 faces, 3 times for each face		
Isolation data				
Rated insulation voltage U_i	input circuit / output circuit	3 kV AC		
	input / PE	1.5 kV AC		
	output / PE	0.5 kV AC; 0.71 kV DC		
Pollution degree		2		
Overvoltage category (UL/IEC/EN 60950-1)		II		
Standards				
Product standard		EN 61204-3		
Low Voltage Directive		2006/95/EC		
EMC directive		2004/108/EC		
RoHS directive		2011/65/EC		
Electrical safety		EN 60950-1, UL 60950-1, UL 508	EN 60950-1, UL 60950-1, UL 508, EN 61558-1, EN 61558-2-17;	EN 60204-1
Protective low voltage		SELV (EN 60950)		
Electromagnetic compatibility				
Interference immunity to		IEC/EN 61000-6-2		
electrostatic discharge	IEC/EN 61000-4-2	Level 4 (air discharge 15 kV / contact discharge 8 kV)		
radiated, radio-frequency, electromagnetic field	IEC/EN 61000-4-3	Level 3 (10 V/m)		
electrical fast transient/burst	IEC/EN 61000-4-4	Level 4 (4 kV / 2,5 kHz) ; Level 4 (4 kV / 5 kHz)		
surge	IEC/EN 61000-4-5	L-L Level 3 (2 kV) / L-PE Level 4 (4 kV)		
conducted disturbances, induced by radio-frequency fields	IEC/EN 61000-4-6	Level 3 (10 V)		
power frequency magnetic fields	IEC/EN 61000-4-8	Level 4 (30 A/m)		
voltage dips, short interruptions and voltage variations	IEC/EN 61000-4-11	dip: >95 % 10 ms / >30 % 500 ms interruptions: >95 % 5000 ms		
Interference emission		IEC/EN 61000-6-3		
high-frequency radiated	IEC/CISPR 22, EN 55022	Class B		
high-frequency conducted	IEC/CISPR 22, EN 55022	Class B		
limits for harmonic current emissions	IEC/EN 61000-3-2	Class D	Class A	Class D

"Approvals and marks" on page 182

CP-E range

Technical data

Data at $T_a = 25\text{ °C}$, $U_{in} = 230\text{ V AC}$ and rated values, unless otherwise indicated

Type		CP-E 24/0.75	CP-E 24/1.25	CP-E 24/2.5
Input circuit		L, N		
Rated input voltage U_{in}		100-240 V AC		
Input voltage range		90-264 V AC / 120-375 V DC	85-264 V AC / 90-375 V DC	
Frequency range AC		47-63 Hz		
Typical input current	at 115 V AC	335 mA	560 mA	1060 mA
	at 230 V AC	210 mA	330 mA	590 mA
Typical power consumption		22.8 W	36.7 W	69.2 W
Inrush current limiting	at 115 V AC	10 A (max. 3 ms)	20 A (max. 3 ms)	20 A (max. 3 ms)
	at 230 V AC	18 A (max. 3 ms)	40 A (max. 3 ms)	40 A (max. 3 ms)
Discharge current	input / output	0.25 mA		
	input / PE	3.5 mA		
Power failure buffering time	at 115 V AC	min. 20 ms	min. 20 ms	
	at 230 V AC	min. 75 ms	min. 30 ms	
Internal input fuse		2 A slow-acting / 250 V AC		
Power factor correction (PFC)		no		
Indication of operational states				
Output voltage	green LED	OK:  : output voltage OK	OUTPUT OK:  : output voltage OK	
	red LED	LOW:  : output voltage too low	-	-
Output circuit		L+,L-	L+, L+, L-, L-	
Rated output voltage		24 V DC		
Tolerance of the output voltage		0 ... +1 %		
Adjustment range of the output voltage		21.6-28.8 V DC	24-28 V DC	
Rated output power		18 W	30 W	60 W
Rated output current I_r	$T_a \leq 60\text{ °C}$	0.75 A	1.25 A	2.5 A
Derating of the output current	$60\text{ °C} < T_a \leq 70\text{ °C}$	2.5 %/°C		
Signalling output for output voltage OK	DC OK	-	transistor	
Maximum deviation with	load change statical	±2 %	±0.5 %	
	change of output voltage within the input voltage range	±1 %	±0.5 %	
Control time		< 2 ms		
Starting time after applying the supply voltage	at I_r	max. 1 s		
	with 3500 µF	-	max. 2 s	-
	with 7000 µF	max. 1.5 s	-	max. 1.5 s
Rise time	at rated load	max. 150 ms		
	with 3500 µF	-	max. 500 ms	-
	with 7000 µF	max. 500 ms	-	max. 500 ms
Fall time		max. 150 ms		
Residual ripple and switching peaks	BW = 20 MHz	50 mV		
Parallel connection		yes, to enable redundancy		
Series connection		yes, to increase voltage		
Resistance to reverse feed		1 s - max. 35 V DC		
Output circuit - No-load, overload and short-circuit behaviour				
Characteristic curve of output		Hiccup-mode	U/I characteristic curve	
Short-circuit protection		continuous short-circuit proof		
Short-circuit behaviour		Hiccup-mode	continuation with output power limiting	
Overload protection		output power limiting		
No-load protection		continuous no-load stability		
Starting of capacitive loads		7000 µF	3500 µF	7000 µF

CP-E range

Technical data

Data at $T_a = 25\text{ °C}$, $U_{in} = 230\text{ V AC}$ and rated values, unless otherwise indicated

Type		CP-E 24/0.75	CP-E 24/1.25	CP-E 24/2.5
General data				
Power dissipation		typ. 4.45 W	typ. 5.5 W	typ. 8.8 W
Efficiency		typ. 77 %	typ. 86 %	typ. 89 %
Duty time		100 %		
Dimensions (W x H x D)		22.5 x 90 x 114 mm (0.89 x 3.54 x 4.49 in)	40.5 x 90 x 114 mm (1.59 x 3.54 x 4.49 in)	
Weight		0.143 kg (0.315 lb)	0.270 kg (0.60 lb)	0.331 kg (0.73 lb)
Material of housing		Plastic		
Mounting		DIN rail (IEC/EN 60715), snap-on mounting without any tool		
Mounting position		horizontal		
Minimum distance to other units	horizontal / vertical	25 mm / 25 mm (0.98 in / 0.98 in)		
Degree of protection	housing / terminals	IP20 / IP20		
Protection class		I		
Electrical connection - input circuit / output circuit				
Wire size	fine-strand with wire end ferrule	0.2-2.5 mm ² (24-14 AWG)		
	fine-strand without wire end ferrule			
	rigid			
Stripping length		6 mm (0.24 in)		
Tightening torque	input / output	0.6 Nm (5 lb.in)		
Environmental data				
Ambient temperature range	operation	-20...+70 °C	-40...+70 °C	
	rated load	-20...+60 °C	-40...+60 °C	
	storage	-20...+85 °C	-40...+85 °C	
Damp heat (cyclic) (IEC/EN 60068-2-30)		95 % RH, without condensation		
Vibration (sinusoidal) (IEC/EN 60068-2-6)		10-500 Hz, 2 G, along X, Y, Z each axis, 60 min. for each axis		
Shock (half-sine) (IEC/EN 60068-2-27)		15 G, 11 ms, 3 axes, 6 faces, 3 times for each face		
Isolation data				
Rated insulation voltage U_i	input circuit / output circuit	3 kV AC		
	input / PE	1.5 kV AC		
	output / PE	0.5 kV AC; 0.71 kV DC		
Pollution degree		2		
Overvoltage category (UL/IEC/EN 60950-1)		II		
Standards				
Product standard		EN 61204-3		
Low Voltage Directive		2006/95/EC		
EMC directive		2004/108/EC		
RoHS directive		2011/65/EC		
Electrical safety		EN 50178, EN 60950-1, UL 60950-1, UL 508	EN 60950-1, UL 60950-1, UL 508, EN 61558-1, EN 61558-2-17; EN 60204-1	
Protective low voltage		SELV (EN 60950)		
Electromagnetic compatibility				
Interference immunity to		IEC/EN 61000-6-2		
electrostatic discharge	IEC/EN 61000-4-2	Level 4 (air discharge 15 kV / contact discharge 8 kV)		
radiated, radio-frequency, electromagnetic field	IEC/EN 61000-4-3	Level 3 (10 V/m)		
electrical fast transient/burst	IEC/EN 61000-4-4	Level 4 (4 kV / 2.5 kHz) ; Level 4 (4 kV / 5 kHz)		
surge	IEC/EN 61000-4-5	L-L Level 3 (2 kV) / L-PE Level 4 (4 kV)		
conducted disturbances, induced by radio-frequency fields	IEC/EN 61000-4-6	Level 3 (10 V)		
power frequency magnetic fields	IEC/EN 61000-4-8	Level 4 (30 A/m)		
voltage dips, short interruptions and voltage variations	IEC/EN 61000-4-11	dip: >95 % 10 ms / >30 % 500 ms, interruptions: >95 % 5000 ms		
Interference emission		IEC/EN 61000-6-3		
high-frequency radiated	IEC/CISPR 22, EN 55022	Class B		
high-frequency conducted	IEC/CISPR 22, EN 55022	Class B		
limits for harmonic current emissions	IEC/EN 61000-3-2	Class D	Class A	

"Approvals and marks" on page 182

CP-E range

Technical data

Data at $T_a = 25\text{ °C}$, $U_{in} = 230\text{ V AC}$ and rated values, unless otherwise indicated

Type		CP-E 24/5.0	CP-E 24/10.0	CP-E 24/20.0
Input circuit		L, N		
Rated input voltage U_{in}		115 / 230 V AC auto select		115-230 V AC
Input voltage range		90-132 V AC, 180-264 V AC / 210-375 V DC	90-132 V AC, 180-264 V AC / 210-375 V DC	90-264 V AC, 120-375 V DC
Frequency range AC		47-63 Hz		
Typical input current	at 115 V AC	2.2 A	4.0 A	4.9 A
	at 230 V AC	0.83 A	1.55 A	2.5 A
Typical power consumption		140 W	270 W	539 W
Inrush current limiting	at 115 V AC	24 A (max. 5 ms)	30 A (max. 5 ms)	25 A (max. 5 ms)
	at 230 V AC	48 A (max. 5 ms)	60 A (max. 5 ms)	50 A (max. 5 ms)
Discharge current	input / output	0.25 mA		
	input / PE	3.5 mA		
Power failure buffering time	at 115 V AC	min. 25 ms		
	at 230 V AC	min. 30 ms		
Internal input fuse		3.15 A slow-acting / 250 V AC	6.3 A slow-acting / 250 V AC	10 A slow-acting / 250 V AC
Power factor correction (PFC)		yes, passive, 0.7		yes, active 115 V AC: 0.99 230 V AC: 0.97
Indication of operational states				
Output voltage	green LED	OUTPUT OK: : output voltage OK		
	red LED	OUTPUT LOW: : output voltage too low		
Output circuit		L+, L+, L-, L-		
Rated output voltage		24 V DC		
Tolerance of the output voltage		0...+1 %		
Adjustment range of the output voltage		22.5-28.5 V DC		
Rated output power		120 W	240 W	480 W
Rated output current I_r	$T_a \leq 60\text{ °C}$	5 A	10 A	-
	$T_a \leq 55\text{ °C}$	-	-	20 A
Derating of the output current	$60\text{ °C} < T_a \leq 70\text{ °C}$	2.5 %/°C		
	$55\text{ °C} < T_a \leq 70\text{ °C}$	-	-	2.5 %/°C
Signalling contact for output voltage OK	13-14	solid-state (max. 60 V DC, 0.3 A)		
Minimum fuse rating to achieve short-circuit protection	13-14	$\geq 60\text{ V DC}$, $\leq 0.3\text{ A}$ fast-acting		
Maximum deviation with	load change statical change of output voltage within the input voltage range	$\pm 1\%$ (single mode), $\pm 5\%$ (parallel mode) $\pm 0.5\%$		
Control time		< 2 ms		
Starting time after applying the supply voltage	at I_r	max. 1 s		
	with 3500 μF	max. 1.5 s	-	-
	with 7000 μF	-	max. 1.5 s	
Rise time	at rated load	max. 150 ms		
	with 3500 μF	max. 500 ms	-	-
	with 7000 μF	-	max. 500 ms	
Fall time		max. 150 ms		
Residual ripple and switching peaks	BW = 20 MHz	50 mV	100 mV	
Parallel connection		configurable, to increase power, up to 3 devices, min. 0.1 I_r - max. 0.9 I_r		
Series connection		yes, to increase voltage, max. 2 devices		
Resistance to reverse feed		max. 35 V DC		
Output circuit - No-load, overload and short-circuit behaviour				
Characteristic curve of output		U/I characteristic curve		
Short-circuit protection		continuous short-circuit proof		
Short-circuit behaviour		continuation with output power limiting		
Overload protection		output power limiting		
No-load protection		continuous no-load stability		
Starting of capacitive loads		3500 μF	7000 μF	

CP-E range

Technical data

Data at $T_a = 25\text{ °C}$, $U_{in} = 230\text{ V AC}$ and rated values, unless otherwise indicated

Type		CP-E 24/5.0	CP-E 24/10.0	CP-E 24/20.0
General data				
Power dissipation		typ. 20 W	typ. 35 W	typ. 63 W
Efficiency		typ. 86 %	typ. 89 %	typ. 89 %
Duty time		100 %		
Dimensions (W x H x D)		63.2 x 123.6 x 123.6 mm (2.49 x 4.87 x 4.87 in)	83 x 123.6 x 123.6 mm (3.27 x 4.87 x 4.87 in)	175 x 123.6 x 123.6 mm (6.89 x 4.87 x 4.87 in)
Weight		0.882 kg (1.945 lb)	1.334 kg (2.941 lb)	1.850 kg (4.079 lb)
Material of housing		Metal		
Mounting		DIN rail (IEC/EN 60715), snap-on mounting without any tool		
Mounting position		horizontal		
Minimum distance to other units	horizontal / vertical	25 mm / 25 mm (0.98 in / 0.98 in)		
Degree of protection	housing / terminals	IP20 / IP20		
Protection class		I		
Electrical connection - input circuit / output circuit				
Wire size	fine-strand with wire end ferrule	0.2-4 mm ² (24-11 AWG)		
	fine-strand without wire end ferrule	0.2-6 mm ² (24-10 AWG)		
	rigid			
Stripping length		8 mm (0.31 in)		
Tightening torque	input / output	1.0 Nm (9 lb.in) / 0.62 Nm (5.5 lb.in)		
Environmental data				
Ambient temperature range	operation	-35...+70 °C	-40...+70 °C	
	rated load	-35...+60 °C	-40...+60 °C	-40...+55 °C
	storage	-40...+85 °C	-40...+85 °C	
Damp heat (cyclic) (IEC/EN 60068-2-30)		95 %RH, without condensation		
Vibration (sinusoidal) (IEC/EN 60068-2-6)		10-500 Hz, 2 G, along X, Y, Z each axis, 60 min. for each axis		
Shock (half-sine) (IEC/EN 60068-2-27)		15 G, 11 ms, 3 axes, 6 faces, 3 times for each face		
Isolation data				
Rated insulation voltage U_i	input circuit / output circuit	3 kV AC		
	input / PE	1.5 kV AC		
	output / PE	0.5 kV AC; 0.71 kV DC		
	signalling contact / PE	0.5 kV DC		
Pollution degree		2		
Overvoltage category (UL/IEC/EN 60950-1)		II		
Standards				
Product standard		EN 61204-3		
Low Voltage Directive		2006/95/EC		
EMC directive		2004/108/EC		
RoHS directive		2011/65/EC		
Electrical safety		EN 60950-1, UL 60950-1, UL 508, EN 61558-1, EN 61558-2-17; EN 60204-1		
Protective low voltage		SELV (EN 60950)		
Electromagnetic compatibility				
Interference immunity to		IEC/EN 61000-6-2		
electrostatic discharge	IEC/EN 61000-4-2	Level 4 (air discharge 15 kV / contact discharge 8 kV)		
radiated, radio-frequency, electromagnetic field	IEC/EN 61000-4-3	Level 3 (10 V/m)		
electrical fast transient/burst	IEC/EN 61000-4-4	Level 4 (4 kV / 5 kHz)	Level 4 (4 kV / 2.5 kHz)	
surge	IEC/EN 61000-4-5	L-L Level 3 (2 kV) / L-PE Level 4 (4 kV)		
conducted disturbances, induced by radio-frequency fields	IEC/EN 61000-4-6	Level 3 (10 V)		
power frequency magnetic fields	IEC/EN 61000-4-8	Level 4 (30 A/m)		
voltage dips, short interruptions and voltage variations	IEC/EN 61000-4-11	dip: >95 % 10 ms / >30 % 500 ms interruptions: >95 % 5000 ms		
Interference emission		IEC/EN 61000-6-3		
high-frequency radiated	IEC/CISPR 22, EN 55022	Class B		
high-frequency conducted	IEC/CISPR 22, EN 55022	Class B		
limits for harmonic current emissions		Class D		

"Approvals and marks" on page 182

CP-E range

Technical data

Data at $T_a = 25\text{ °C}$, $U_{in} = 230\text{ V AC}$ and rated values, unless otherwise indicated

Type	CP-E 48/0.62	CP-E 48/1.25	CP-E 48/5.0	CP-E 48/10.0
Input circuit	L, N			
Rated input voltage U_{in}	100-240 V AC		115 / 230 V AC auto select	115-230 V AC
Input voltage range	85-264 V AC / 90-375 V DC		90-132 V AC, 180-264 V AC / 210-375 V DC	90-264 V AC, 120-375 V DC
Frequency range AC	47-63 Hz			
Typical input current	at 115 V AC 560 mA	1060 mA	4.0 A	4.9 A
	at 230 V AC 330 mA	590 mA	1.55 A	2.5 A
Typical power consumption	35.7 W	69.0 W	267 W	528 W
Inrush current limiting	at 115 V AC 20 A (max. 3 ms)	20 A (max. 3 ms)	30 A (max. 5 ms)	25 A (max. 5 ms)
	at 230 V AC 40 A (max. 3 ms)	40 A (max. 3 ms)	60 A (max. 5 ms)	50 A (max. 5 ms)
Discharge current	input / output 0.25 mA			
	input / PE 3.5 mA			
Power failure buffering time	at 115 V AC min. 20 ms		min. 25 ms	min. 25 ms
	at 230 V AC min. 30 ms			
Internal input fuse	2 A slow-acting / 250 V AC		6.3 A slow-acting / 250 V AC	10 A slow-acting / 250 V AC
Power factor correction (PFC)	no		yes, passive, 0.7	yes, active 115 V AC: 0.99 230 V AC: 0.97
Indication of operational states				
Output voltage	green LED	OUTPUT OK: : output voltage OK		
	red LED	-	OUTPUT LOW: : output voltage too low	
Output circuit	L+, L+, L-, L-			
Rated output voltage	48 V DC			
Tolerance of the output voltage	0...+1 %			
Adjustment range of the output voltage	48-55 V DC		47-56 V DC	
Rated output power	30 W	60 W	240 W	480 W
Rated output current I_r	$T_a \leq 60\text{ °C}$ 0.625 A	1.25 A	5 A	-
	$T_a \leq 55\text{ °C}$ -	-	-	10 A
Derating of the output current	$60\text{ °C} < T_a \leq 70\text{ °C}$ 2.5 %/°C	-	-	-
	$55\text{ °C} < T_a \leq 70\text{ °C}$ -	-	-	2.5 %/°C
Signalling output for output voltage OK	DC OK	-	-	-
Maximum deviation with load change statical	±0.5 %		±1 % (single mode) ±5 % (parallel mode)	
	change of output voltage within the input voltage range		±0.5 %	
Control time	< 2 ms			
Starting time after applying the supply voltage	at I_r max. 1 s			
	with 3500 µF max. 2 s	-	-	-
	with 7000 µF -	max. 1.5 s	max. 1.5 s	-
Rise time	at rated load max. 150 ms			
	with 3500 µF max. 500 ms	-	-	-
	with 7000 µF -	max. 500 ms	max. 500 ms	-
Fall time	max. 150 ms			
Residual ripple and switching peaks	BW = 20 MHz	50 mV		100 mV
Parallel connection	yes, to enable redundancy		configurable, to increase power, up to 3 devices, min. 0.1 I_r - max. 0.9 I_r	
Series connection	yes, to increase voltage		yes, to increase voltage, max. 2 devices	
Resistance to reverse feed	1 s - max. 63 V DC			
Output circuit - No-load, overload and short-circuit behaviour				
Characteristic curve of output	U/I characteristic curve			
Short-circuit protection	continuous short-circuit proof			
Short-circuit behaviour	continuation with output power limiting			
Overload protection	output power limiting			
No-load protection	continuous no-load stability			
Starting of capacitive loads	3500 µF	7000 µF	unlimited	7000 µF

CP-E range

Technical data

Data at $T_a = 25\text{ °C}$, $U_n = 230\text{ V AC}$ and rated values, unless otherwise indicated

Type	CP-E 48/0.62	CP-E 48/1.25	CP-E 48/5.0	CP-E 48/10.0
General data				
Power dissipation	typ. 4.9 W	typ. 7.8 W	typ. 32 W	typ. 60 W
Efficiency	typ. 86 %	typ. 89 %	typ. 90 %	
Duty time	100 %			
Dimensions (W x H x D)	40.5 x 90 x 114 mm (1.59 x 3.54 x 4.49 in)		83 x 123.6 x 123.6 mm (3.27 x 4.87 x 4.87 in)	175 x 123.6 x 123.6 mm (6.89 x 4.87 x 4.87 in)
Weight	0.264 kg (0.582 lb)	0.316 kg (0.697 lb)	1.322 kg (2.915 lb)	1.839 kg (4.054 lb)
Material of housing	Plastic		Metal	
Mounting	DIN rail (IEC/EN 60715), snap-on mounting without any tool			
Mounting position	horizontal			
Minimum distance to other units	horizontal / vertical		25 mm / 25 mm (0.98 in / 0.98 in)	
Degree of protection	housing / terminals		IP/20 / IP20	
Protection class	I			
Electrical connection - input circuit / output circuit				
Wire size	fine-strand with wire end ferrule		0.2-4 mm ² (24-11 AWG)	
	fine-strand without wire end ferrule		0.2-2.5 mm ² (24-14 AWG)	
	rigid		0.2-6 mm ² (24-10 AWG)	
Stripping length	6 mm (0.24 in)		8 mm (0.31 in)	
Tightening torque	input / output		0.6 Nm (5 lb.in) / 1.0 Nm (9 lb.in) / 0.62 Nm (5.5 lb.in)	
Environmental data				
Ambient temperature range	operation		-40...+70 °C	
	rated load		-40...+60 °C	
	storage		-40...+85 °C	
Damp heat (cyclic) (IEC/EN 60068-2-30)	95 % RH, without condensation			
Vibration (sinusoidal) (IEC/EN 60068-2-6)	10-500 Hz, 2 G, along X, Y, Z each axis, 60 min. for each axis			
Shock (half-sine) (IEC/EN 60068-2-27)	15 G, 11 ms, 3 axes, 6 faces, 3 times for each face			
Isolation data				
Rated insulation voltage U_i	input circuit / output circuit		3 kV AC	
	input / PE		1.5 kV AC	
	output / PE		0.5 kV AC; 0.71 kV DC	
Pollution degree	2			
Overvoltage category (UL/IEC/EN 60950-1)	II			
Standards				
Product standard	EN 61204-3			
Low Voltage Directive	2006/95/EC			
EMC directive	2004/108/EC			
RoHS directive	2011/65/EC			
Electrical safety	EN 60950-1, UL 60950-1, UL 508, EN 61558-1, EN 61558-2-17; EN 60204-1			
Protective low voltage	SELV (EN 60950)			
Electromagnetic compatibility				
Interference immunity to	IEC/EN 61000-6-2			
electrostatic discharge	IEC/EN 61000-4-2	Level 4 (air discharge 15 kV / contact discharge 8 kV)		
radiated, radio-frequency, electromagnetic field	IEC/EN 61000-4-3	Level 3 (10 V/m)		
electrical fast transient/burst	IEC/EN 61000-4-4	Level 4 (4 kV / 5 kHz)	Level 4 (4 kV / 2.5 kHz)	
surge	IEC/EN 61000-4-5	L-L Level 3 (2 kV) / L-PE Level 4 (4 kV)		
conducted disturbances, induced by radio-frequency fields	IEC/EN 61000-4-6	Level 3 (10 V/m)		
power frequency magnetic fields	IEC/EN 61000-4-8	Level 4 (30 A/m)		
voltage dips, short interruptions and voltage variations	IEC/EN 61000-4-11	dip: >95 % 10 ms / >30 % 500 ms, interruptions: >95 % 5000 ms		
Interference emission	IEC/EN 61000-6-3			
high-frequency radiated	IEC/CISPR 22, EN 55022	Class B		
high-frequency conducted	IEC/CISPR 22, EN 55022	Class B		
limits for harmonic current emissions			Class A	
			Class D	

"Approvals and marks" on page 182

CP-E range

Technical diagrams, Wiring instructions

Output curve at $T_a = 25^\circ\text{C}$

3

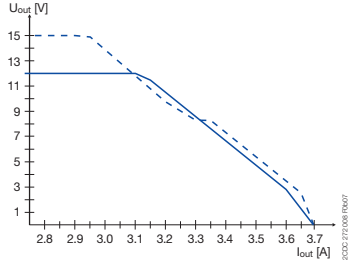

CP-E 12/2.5

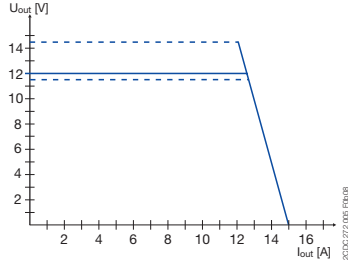

CP-E 12/10.0

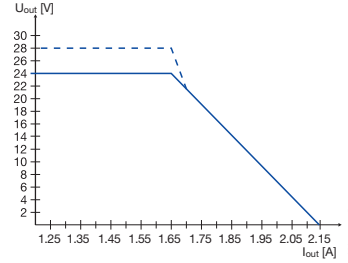

CP-E 24/1.25

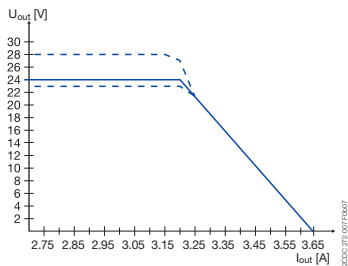

CP-E 24/2.5

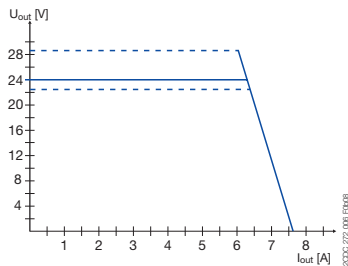

CP-E 24/5.0

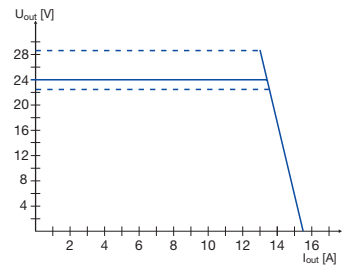

CP-E 24/10.0

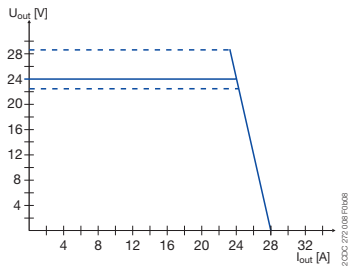

CP-E 24/20.0

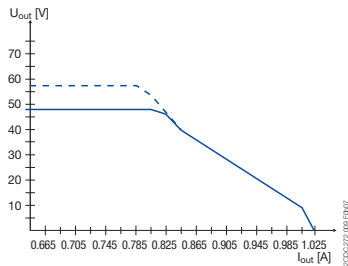

CP-E 48/0.62

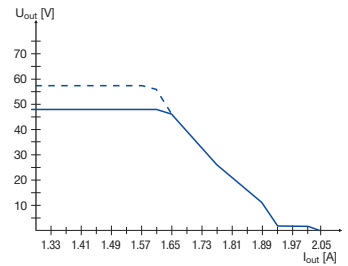

CP-E 48/1.25

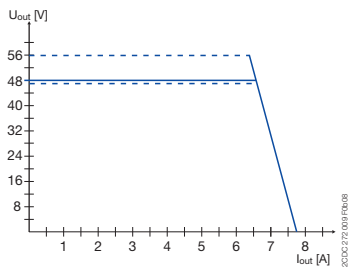

CP-E 48/5.0

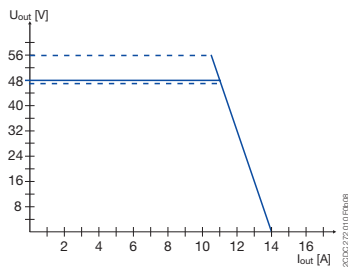

CP-E 48/10.0

Wiring instructions

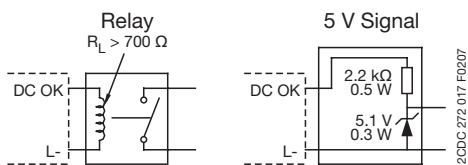

CP-E 24/1.25, CP-E 24/2.5

CP-E range

Technical diagrams, Dimensional drawings

Temperature behaviour at $T_a = 25\text{ °C}$

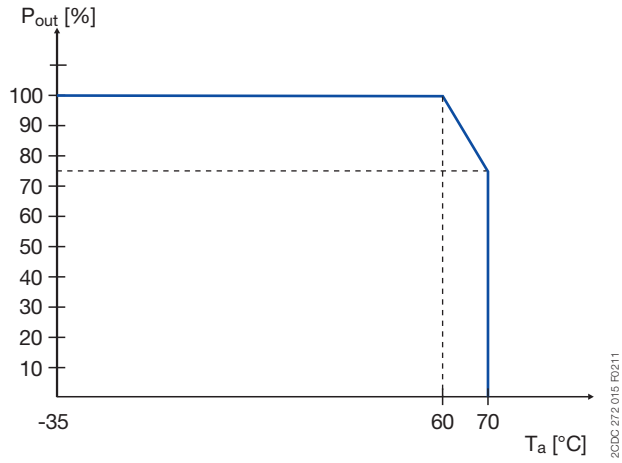

CP-E 12/10.0, CP-E 24/5.0

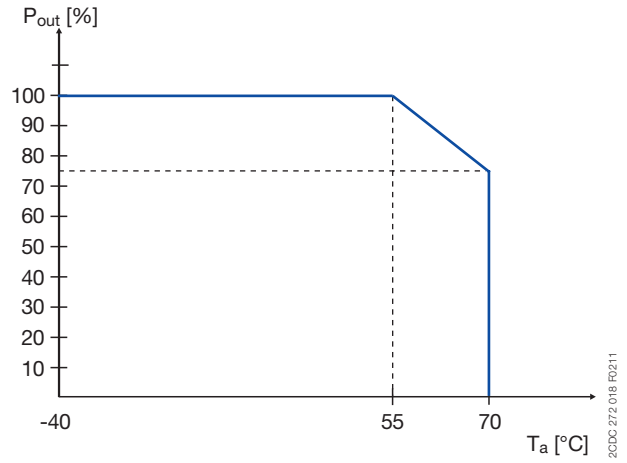

CP-E 24/20.0, CP-E 48/10.0

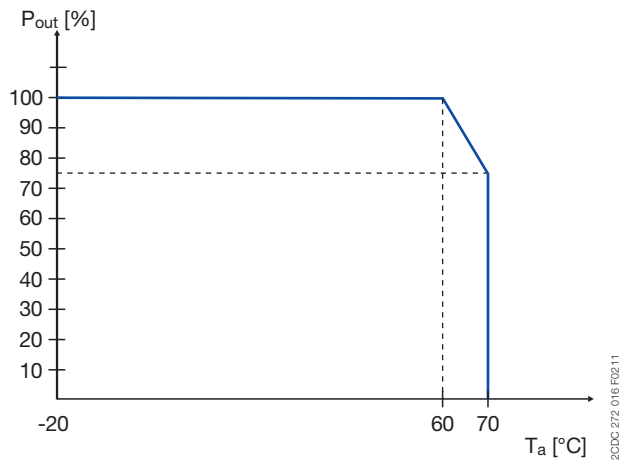

CP-E 5/3.0, CP-E 24/0.75

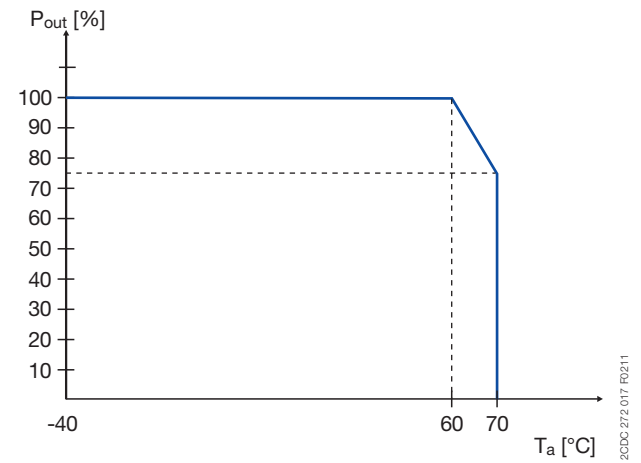

CP-E 12/2.5, CP-E 24/1.25, CP-E 48/0.62,
CP-E 24/2.5, CP-E 48/1.25, CP-E 24/10.0, CP-E 48/5.0

Dimensional drawings dimensions in mm

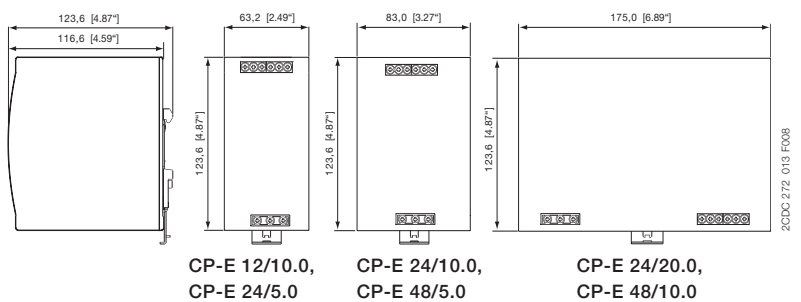
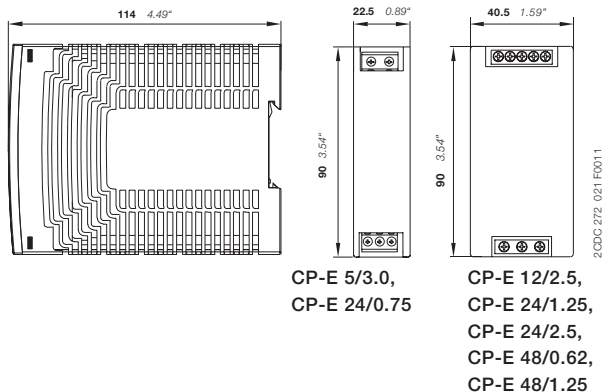

CP-T range Product group picture

3



CP-T range

Table of contents

CP-T range	
CP-T range	210
Table of contents	210
Benefits and advantages	211
Ordering details	212
Technical data	213
Technical diagrams, Dimensional drawings	217
Technical diagrams	218

CP-T range

Benefits and advantages

Characteristics

- Rated output voltages 24 V, 48 V DC
- Output voltage adjustable via front-face rotary potentiometer "OUTPUT Adjust"
- Rated output currents 5 A, 10 A, 20 A, 40 A
- Rated output powers 120 W, 240 W, 480 W, 960 W
- Three-phase operation (see derating note)
- Two-phase operation (25 % derating possible, see derating note)
- Supply range 3 x 400–500 V AC (3 x 340–575 V AC, 480–820 V DC)
- Typical efficiency of 93 %
- Low power dissipation and low heating
- Free convection cooling (no forced cooling with ventilators)
- Ambient temperature range during operation -40...+70 °C ¹⁾
- Open-circuit, overload and short-circuit stable
- Integrated input fuse
- Redundancy unit CP-A RU offering true redundancy, available as accessory
- LEDs for status indication
- Signalling contact "13-14" (solid state) for output voltage OK
- Approvals / marks (depending on device, partly pending):

- 

¹⁾ 480 W variants: -30...+70°C

Benefits

Signalling output ①

The devices of the CP-T series offer a solid state output for function monitoring and remote diagnostics.

Wide input range

Wide range input optimized for world-wide applications: The CP-T power supplies can be used in 340 - 575 V AC or 480 - 820 V DC supply systems.

Adjustable output voltage ②

The CP-T range feature a continuously adjustable output voltage. Thus, they can be optimally adapted to the application, e.g. compensating the voltage drop caused by a long line length.

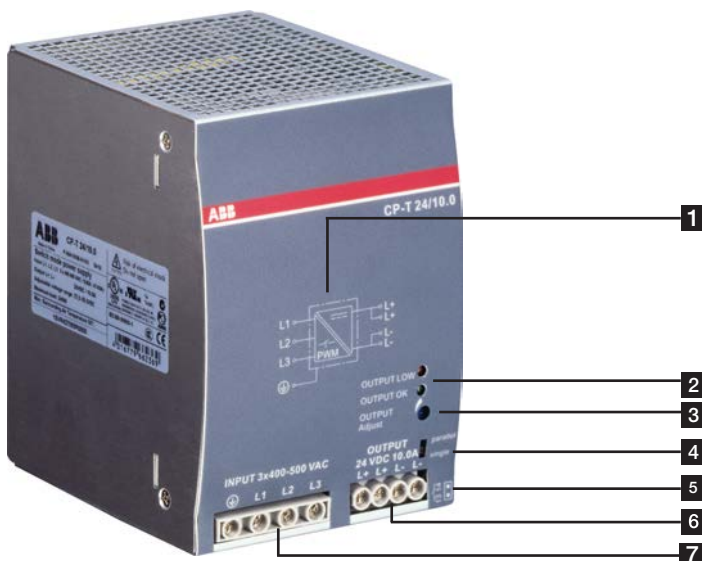
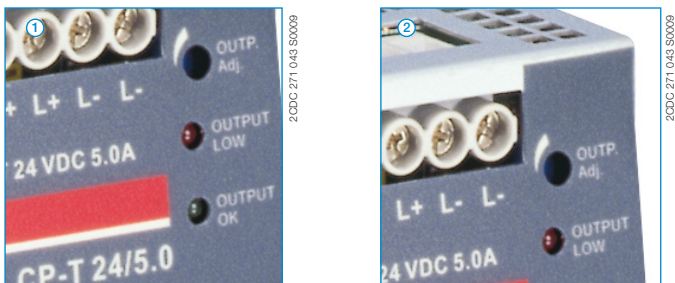

1 Circuit diagram

2 Indication of operational states

DC ON: green LED - green LED - output voltage OK
DC LOW: red LED - output voltage too low

3 OUTPUT Adjust: potentiometer - adjustment of output voltage

4 single/parallel: sliding switch - adjustment of single or parallel operation

5 Signalling contact

OUTPUT 13-14: terminals - signalling contact
A solid-state output indicates the error-free operation of the output voltage.

6 OUTPUT L+, L+, L-, L-: terminals - output

7 INPUT L1, L2, L3, PE: terminals - input

CP-T range

Ordering details



CP-T 24/5.0

2CDC 271 043 S0009



CP-T 24/10.0, CP-T 48/5.0

2CDC 271 045 S0009



CP-T 24/20.0, CP-T 48/10.0

2CDC 271 047 S0009

Description

The CP-T range of three-phase power supply units is the youngest member of ABB's power supply family. In terms of design and functionality, the new range perfectly supplements the existing products and extends the range appropriately. The devices can be supplied with a three-phase voltage as well as with two-phase mains. Here, ABB offers power supply units with 24 V DC and 48 V DC outputs with 5 A, 10 A, 20 A and 40 A and efficiency of up to 92 %. As in the case of all products, they are designed for an ambient temperature of up to 70 °C. All products can be supplied within an AC supply voltage range between 340 to 575 V AC and a DC supply voltage range between 480 to 820 V DC.

Ordering details

Input voltage range	Rated output voltage / current	Type	Order code	Price 1 pce	Weight (1 pce) kg (lb)
340-575 V AC / 480-820 V DC	24 V DC / 5 A	CP-T 24/5.0	1SVR427054R0000		0.80 (1.77)
340-575 V AC / 480-820 V DC	24 V DC / 10 A	CP-T 24/10.0	1SVR427055R0000		1.05 (2.31)
340-575 V AC / 480-820 V DC	24 V DC / 20 A	CP-T 24/20.0	1SVR427056R0000		1.75 (3.86)
340-575 V AC / 480-820 V DC	24 V DC / 40 A	CP-T 24/40.0	1SVR427057R0000		3.20 (7.05)
340-575 V AC / 480-820 V DC	48 V DC / 5 A	CP-T 48/5.0	1SVR427054R2000		1.05 (2.31)
340-575 V AC / 480-820 V DC	48 V DC / 10 A	CP-T 48/10.0	1SVR427055R2000		1.75 (3.86)
340-575 V AC / 480-820 V DC	48 V DC / 20 A	CP-T 48/20.0	1SVR427056R2000		3.40 (7.50)



Further documentation CP-T power supplies on www.abb.com

CP-T range

Technical data

Data at $T_a = 25\text{ °C}$, $U_{in} = 3 \times 400\text{ V AC}$ and rated values, unless otherwise indicated

Type	CP-T 24/5.0	CP-T 24/10.0	CP-T 24/20.0	CP-T 24/40.0
Input circuit	L1, L2, L3			
Rated input voltage U_{in}	3 x 400-500 V AC			
Input voltage range	340-575 V AC 480-820 V DC			
Frequency range AC	47-63 Hz			
Typical input current	0.36 A	0.65 A	1.1 A	1.72 A
Typical power consumption	135 W	270 W	538 W	1058 W
Inrush current limiting	10 A	20 A		30 A
Power failure buffering time	min. 20 ms			min. 15 ms
Internal input fuse	per phase 2 A / 600 V AC		T 3.15 A / 500 V AC	T 5 A / 500 V AC
Recommended backup fuse	3 pole miniature circuit breaker ABB Type S203			
Power factor correction (PFC)	Yes, passive			
Discharge current	towards PE	< 3.5 mA		
	input / output	< 0.25 mA		
Indication of operational states				
Output voltage	OUTPUT OK: green LED	output voltage OK		
	OUTPUT LOW: red LED	output voltage too low		
Output circuit	L+, L+, L-, L-			
Rated output voltage	24 V DC			
Tolerance of the output voltage	0...+1 %			
Adjustment range of the output voltage	22.5-28.5 V DC			
Rated output power	120 W	240 W	480 W	960 W
Rated output current I_r	$T_a \leq 60\text{ °C}$	5 A	10 A	20 A
Derating of the output current	$60\text{ °C} < T_a \leq 70\text{ °C}$	2.5 %/°C		3.5 %/°C
Signalling contact for output voltage OK	13-14	solid state (max. 60 V DC, 0.3 A)		
	Threshold	17.6-19.4 V		
	Insulation voltage	500 V DC		
Minimum fuse rating to achieve short-circuit protection	13-14	$\geq 60\text{ V DC}$, $\leq 0.3\text{ A}$ fast-acting		
Maximum deviation with load change statical		$\pm 1\%$	$\pm 1\%$ (single mode)	$\pm 5\%$ (parallel mode)
	change of output voltage within the input voltage range	$\pm 0.5\%$		
Control time at nominal load	< 2 ms			
Starting time after applying the supply voltage	at I_r	max. 1 s		
	with 3500 μF	max. 1.5 s		
Rise time at nominal load	max. 150 ms			
	with 3500 μF	max. 500 ms		
Fall time	max. 150 ms			
Residual ripple and switching peaks	BW = 20 MHz	100 mV		80 mV
Parallel connection	not supported	configurable, to increase power, up to 2 devices, min. 0.1 I_r - max 0.9 I_r)		to increase power, up to 2 devices, min. 0.1 I_r - max. 0.9 I_r , use active current balancing
Series connection	not supported	yes, to increase voltage, max. 2 devices		
Resistance to reverse feed	approx. 35 V			
Output circuit - No-load, overload and short-circuit behaviour				
Characteristic curve of output	combined U/I characteristic curve and hiccup mode	U/I- or Hiccup-mode adjustable	hiccup / fold back behavior	
Short-circuit protection	continuous short-circuit proof			
Short-circuit behaviour	current limiting			
Overload protection	hiccup mode			
No-load protection	continuous no-load stability			
Overtemperature protection	yes, automatic recovery after temperature went down			
Starting of capacitive loads	3500 μF	7000 μF	7000 μF	7000 μF

CP-T range

Technical data

Data at $T_a = 25\text{ °C}$, $U_{in} = 3 \times 400\text{ V AC}$ and rated values, unless otherwise indicated

Type		CP-T 24/5.0	CP-T 24/10.0	CP-T 24/20.0	CP-T 24/40.0
General data					
Efficiency		typ. 89 %	typ. 90 %		typ. 92 %
Duty time		100%			
Dimensions (W x H x D)		74.3 x 124 x 118.8 mm (2.92 x 4.88 x 4.68 in)	89 x 124 x 118.8 mm (3.5 x 4.88 x 4.68 in)	150 x 124 x 118.8 mm (5.91 x 4.88 x 4.68 in)	275.8 x 124 x 118.8 mm (10.86 x 4.88 x 4.68 in)
Weight		0.78 kg (1.72 lb)	1.045 kg (2.30 lb)	1.657 kg (3.653 lb)	3.275 kg (7.220 lb)
Material of housing		Metal			
Mounting		DIN rail (IEC EN 60715), snap-on mounting without any tool			
Mounting position		horizontal			
Minimum distance to other units	horizontal / vertical	25 mm / 25 mm (0.98 in / 0.98 in)			
Degree of protection	housing / terminals	IP20 / IP20			
Protection class		I			
Electrical connection - input circuit / output circuit / signalling circuit					
Wire size	fine-strand with wire end ferrule	0.2-4 mm ² (24-11 AWG)			
	fine-strand without wire end ferrule	0.2-6 mm ² (24-10 AWG)			
	rigid	0.2-6 mm ² (24-10 AWG)			
Stripping length		8 mm (0.31 in)			
Tightening torque	input / output	1 Nm (9 lb.in) / 0.6 Nm (5.5 lb.in)			1 Nm (9 lb.in) / 1.8 Nm (15.6 lb.in)
Environmental data					
Ambient temperature range	operation	-40...+70 °C		-30...+70 °C	-40...+70 °C
	rated load	-40...+60 °C		-30...+60 °C	-40...+60 °C
	storage	-40...+85 °C			
Damp heat (cyclic) (IEC/EN 60068-2-30)		95 % without condensation			
Vibration (sinusoidal) (IEC/EN 60068-2-6)		2 g, 10-500 Hz, 2G, each along X, Y, Z axes 60 min / cycle			
Shock (half-sine) (IEC/EN 60068-2-27)		15 g, 11 ms, 3 axes, 6 faces, 3 times for each face			
Isolation data					
Rated insulation voltage U_i	input circuit / output circuit	3 kV AC			
	input / PE	1.5 kV AC			
	output / PE	0.5 kV AC; 0.71 kV DC			
	signalling output / PE	0.5 kV DC			
Pollution degree		2			
Standards					
Product standard		EN 61204-3			
Low Voltage Directive		2006/95/EC			
EMC directive		2004/108/EC			
RoHS directive		2011/65/EC			
Electrical safety		EN 60950-1, UL 60950-1, UL 508, EN 61558-1, EN 61558-2-17; EN 60204-1			
Protective low voltage		SELV			
Electromagnetic compatibility					
Interference immunity to		IEC/EN 61000-6-2			
electrostatic discharge	IEC/EN 61000-4-2	Level 4 (air discharge 15 kV / contact discharge 8 kV)			
radiated, radio-frequency, electromagnetic field	IEC/EN 61000-4-3	Level 3 (10 V/m)			
electrical fast transient/burst	IEC/EN 61000-4-4	Level 4 (4 kV / 2.5 kHz)	Level 4 (4 kV / 5 kHz)		
surge	IEC/EN 61000-4-5	L-L Level 3 (2 kV) / L-PE Level 4 (4 kV)			
conducted disturbances, induced by radio-frequency fields	IEC/EN 61000-4-6	Level 3 (10 V)			
power frequency magnetic fields	IEC/EN 61000-4-8	Level 4 (30 A/m)			
voltage dips, short interruptions and voltage variations	IEC/EN 61000-4-11	dips: >95 % 0.5 ms / >30 % 0.5 ms, interruptions: >95 % 250 ms			
Interference emission		IEC/EN 61000-6-3			
high-frequency radiated	IEC/CISPR 22, EN 55022	Class B			
high-frequency conducted	IEC/CISPR 22, EN 55022	Class B			
limits for harmonic current emissions	IEC/EN 61000-3-2	Class A			

"Approvals and marks" on page 182

CP-T range

Technical data

Data at $T_a = 25\text{ °C}$, $U_{in} = 3 \times 400\text{ V AC}$ and rated values, unless otherwise indicated

Type	CP-T 48/5.0	CP-T 48/10.0	CP-T 48/20.0
Input circuit			
Rated input voltage U_{in}	3 x 400-500 V AC		
Input voltage range	340-575 V AC 480-820 V DC		
Frequency range AC	47-63 Hz		
Typical input current	0.65 A	1.1 A	1.72 A
Typical power consumption	264 W	535 W	1050 W
Inrush current limiting	20 A		30 A
Power failure buffering time	min. 20 ms		min. 15 ms
Internal input fuse	per phase	2 A / 600 V AC	T3.15 A / 500 V AC
Power factor correction (PFC)	yes, passive		
Discharge current	towards PE	< 3.5 mA	
	input / output	< 0.25 mA	
Indication of operational states			
Output voltage	OUTPUT OK: green LED	output voltage OK	
	OUTPUT LOW: red LED	output voltage too low	
Output circuit			
Rated output voltage	48 V DC		
Tolerance of the output voltage	0...+1 %		
Adjustment range of the output voltage	47-56 V DC		
Rated output power	240 W	480 W	960 W
Rated output current I_r	$T_a \leq 60\text{ °C}$	5 A	10 A
Derating of the output current	$60\text{ °C} < T_a \leq 70\text{ °C}$	2.5 %/°C	
Maximum deviation with	load change statcal	$\pm 1\%$ (single mode) $\pm 5\%$ (parallel mode)	
	change of output voltage within the input voltage range	$\pm 0.5\%$	
Control time	at rated load	< 2 ms	
Starting time after applying the supply voltage	at I_r	max. 1 s	
	with 7000 μF	max. 1.5 s	
Rise time	at rated load	max. 150 ms	
	with 7000 μF	max. 500 ms	
Fall time		max. 150 ms	
Residual ripple and switching peaks	BW = 20 MHz	100 mV	80 mV
Parallel connection		configurable, to increase power, up to 2 devices, min. $0.1 I_r$ - max $0.9 I_r$)	to increase power, up to 2 devices, min. $0.1 I_r$ - max. $0.9 I_r$, use active current balancing
Series connection		yes, to increase voltage, max. 2 devices	
Resistance to reverse feed		approx. 35 V	approx. 63 V
		approx. 63 V	approx. 63 V
Output circuit - No-load, overload and short-circuit behaviour			
Characteristic curve of output	combined U/I and hiccup mode	U/I or hiccup mode, configurable	hiccup mode / fold back behavior
Short-circuit protection	continuous short-circuit proof		
Short-circuit behaviour	current limiting		
Overload protection	hiccup mode		
No-load protection	continuous no-load stability		
Over temperature protection	yes, automatic recovery after temperature went down		
Starting of capacitive loads	7000 μF		

CP-T range

Technical data

Data at $T_a = 25\text{ °C}$, $U_{in} = 3 \times 400\text{ V AC}$ and rated values, unless otherwise indicated

Type		CP-T 48/5.0	CP-T 48/10.0	CP-T 48/20.0
General data				
Efficiency		typ. 91 %		typ. 93 %
Duty time		100%		
Dimensions (W x H x D)		89 x 124 x 118.8 mm (3.5 x 4.88 x 4.68 in)	150 x 124 x 118.8 mm (5.91 x 4.88 x 4.68 in)	275.8 x 124 x 118.8 mm (10.86 x 4.88 x 4.68 in)
Weight		1.045 kg (2.30 lb)	1.657 kg (3.653 lb)	3.275 kg (7.22 lb)
Material of housing		Metal		
Mounting		DIN rail (IEC EN 60715), snap-on mounting without any tool		
Mounting position		horizontal		
Minimum distance to other units	horizontal / vertical	25 mm / 25 mm (0.98 in / 0.98 in)		
Degree of protection	housing / terminals	IP20 / IP20		
Protection class		I		
Electrical connection - input circuit / output circuit				
Wire size	fine-strand with wire end ferrule	0.2-4 mm ² (24-11 AWG)		0.2-4 mm ² (24-11 AWG) / 0.5-10 mm ² (20-8 AWG)
	fine-strand without wire end ferrule rigid	0.2-6 mm ² (24-10 AWG)		
Stripping length		8 mm (0.31 in)		
Tightening torque	input / output	1 Nm (9 lb.in) / 0.6 Nm (5.5 lb.in)		1 Nm (9 lb.in) / 1.8 Nm (15.6 lb.in)
Environmental data				
Ambient temperature range	operation	-40...+70 °C	-30...+70 °C	-40...+70 °C
	rated load	-40...+60 °C	-30...+60 °C	-40...+60 °C
	storage	-40...+85 °C	-40...+85 °C	-40...+85 °C
Damp heat (cyclic) (IEC/EN 60068-2-30)		95 % without condensation		
Vibration (sinusoidal) (IEC/EN 60068-2-6)		10-500 Hz, 2G, each along X, Y, Z axes 6 min / cycle		
Shock (half-sine) (IEC/EN 60068-2-27)		15G, 11 ms, 3 axes, 6 Faces, 3 times for each face		
Isolation data				
Rated insulation voltage U_i	input circuit / output circuit	3 kV AC		
	input / PE	1.5 kV AC		
	output / PE	0.5 kV AC; 0.71 kV DC		
Pollution degree		2		
Standards				
Product standard		EN 61204-3		
Low Voltage Directive		2006/95/EC		
EMC directive		2004/108/EC		
RoHS directive		2011/65/EC		
Electrical safety		EN 60950-1, UL 60950-1, UL 508, EN 61558-1, EN 61558-2-16; EN 60204-1		
Protective low voltage		SELV		
Electromagnetic compatibility				
Interference immunity to		IEC/EN 61000-6-2		
electrostatic discharge	IEC/EN 61000-4-2	Level 4 (air discharge 15 kV / contact discharge 8 kV)		
radiated, radio-frequency, electromagnetic field	IEC/EN 61000-4-3	Level 3 (10 V/m)		
electrical fast transient/burst	IEC/EN 61000-4-4	Level 4 (4 kV / 5 kHz)		
surge	IEC/EN 61000-4-5	L-L Level 3 (2 kV) / L-PE Level 4 (4 kV)		
conducted disturbances, induced by radio-frequency fields	IEC/EN 61000-4-6	Level 3 (10 V)		
power frequency magnetic fields	IEC/EN 61000-4-8	Level 4 (30 A/m)		
voltage dips, short interruptions and voltage variations	IEC/EN 61000-4-11	dips: >95 % 0.5 ms / >30 % 0.5 ms interruptions: >95 % 250 ms IEC/EN 61000-6-3		
Interference emission				
high-frequency radiated	IEC/CISPR 22, EN 55022	Class B		
high-frequency conducted	IEC/CISPR 22, EN 55022	Class B		
limits for harmonic current emissions	IEC/EN 61000-3-2	Class A		

"Approvals and marks" on page 182

CP-T range

Technical diagrams, Dimensional drawings

Technical diagrams, dimensions in mm
Output curve at $T_a = 25^\circ\text{C}$

3

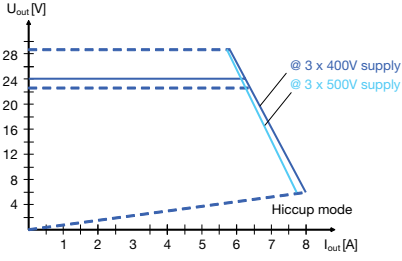

CP-T 24/5.0

2CDC 272 032 F0X09

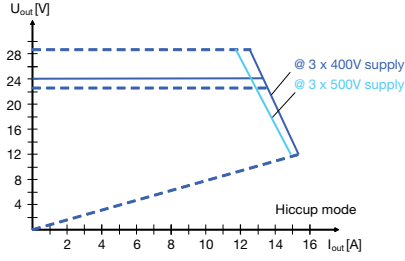

CP-T 24/10.0

2CDC 272 033 F0X09

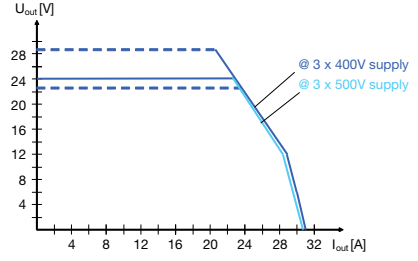

CP-T 24/20.0 U/I curve

2CDC 272 034 F0X09

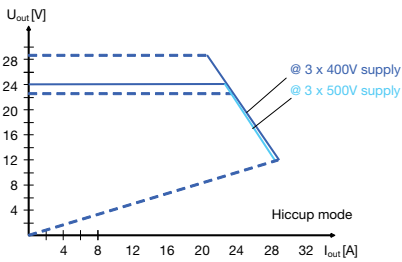

CP-T 24/20.0 Hiccup mode

2CDC 272 035 F0X09

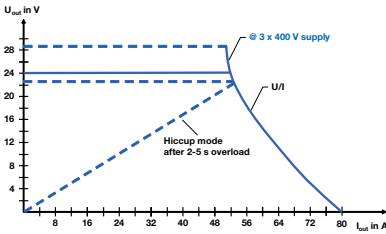

CP-T 24/40.0

2CDC 272 027 F0211

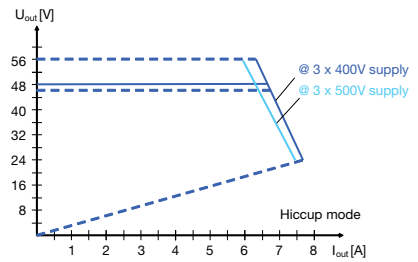

CP-T 48/5.0

2CDC 272 037 F0X09

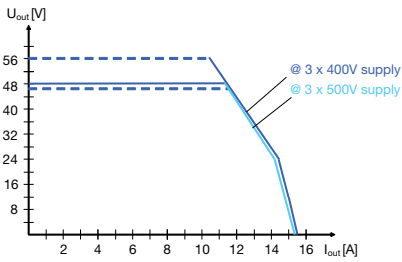

CP-T 48/10.0 U/I curve

2CDC 272 038 F0X09

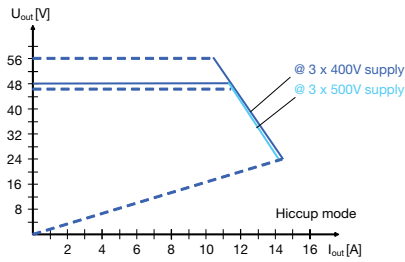

CP-T 48/10.0 Hiccup mode

2CDC 272 039 F0X09

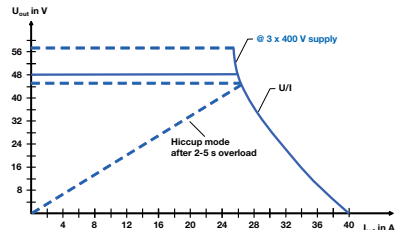

CP-T 48/20.0

2CDC 272 028 F0211

Dimensional drawings dimensions in mm

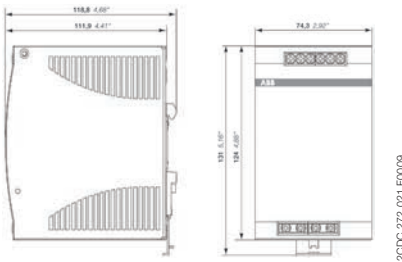

CP-T 24/5.0

2CDC 272 021 F0009

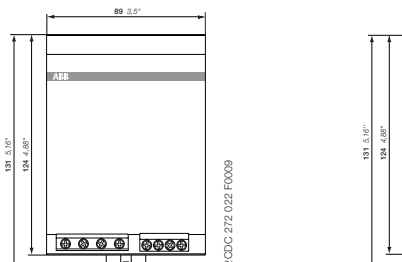

CP-T 24/10.0, CP-T 48/5.0

2CDC 272 032 F0009

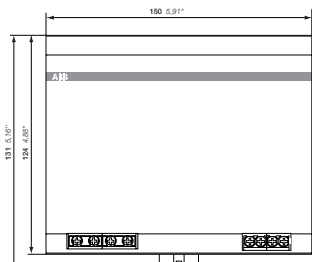

CP-T 24/20.0, CP-T 48/10.0

2CDC 272 023 F0009

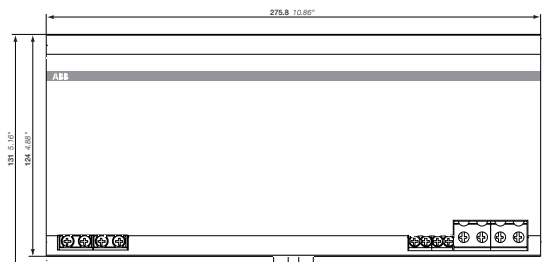

CP-T 24/40.0, CP-T 48/20.0

2CDC 272 024 F0009

CP-T range

Technical diagrams

Temperature curve at rated load

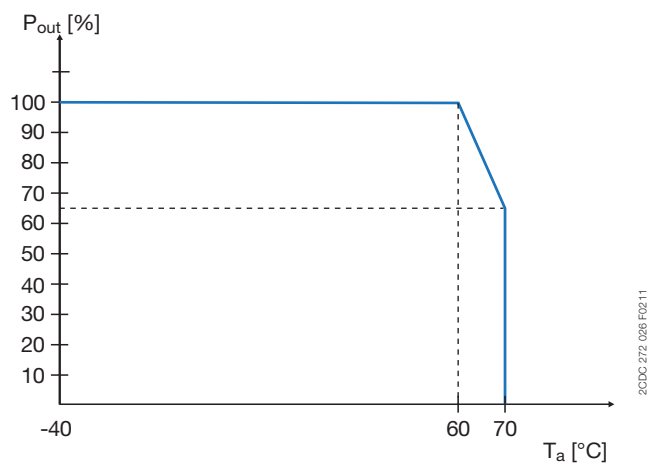

CP-T 24/40.0, CP-T 48/20.0

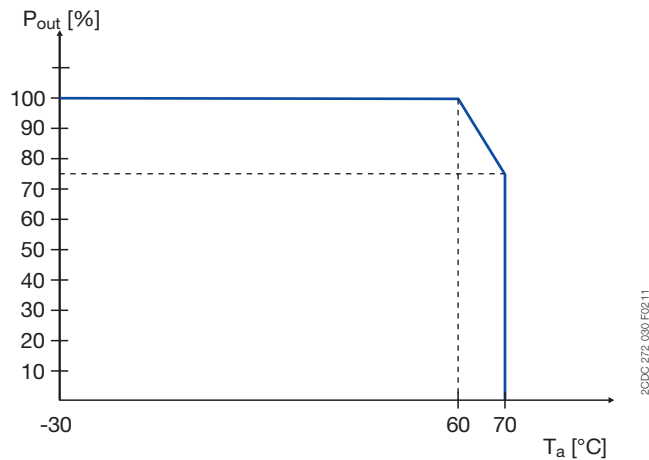

CP-T 24/20.0, CP-T 48/10.0

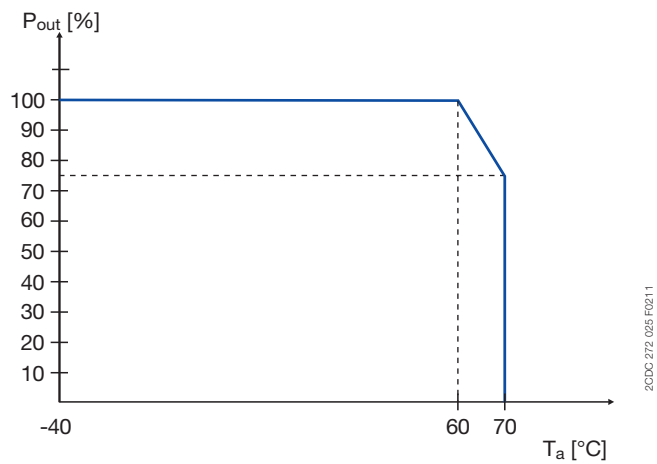

CP-T 24/5.0, CP-T 24/10.0, CP-T 48/5.0

CP-C.1 range Product group picture

3



CP-C.1 range

Product group picture

CP-C.1

CP-C.1 range	220
Benefits and advantages	221
Ordering details	222
Technical data	223
Technical diagrams	226
Technical diagrams, Dimensional drawings	227
Technical diagrams	228

CP-C.1 range

Benefits and advantages

3

Characteristics

- Rated output voltage 24 V DC
- Power reserve design delivers up to 150 % at $T_a \leq 40 \text{ }^\circ\text{C}$
- Output voltage adjustable via front-face rotary potentiometer "OUTPUT Adjust", 22.5-28.5 V
- Input voltage range 100-240 V AC, 90-300 V DC
- High efficiency
- Low power dissipation and low heating
- Free convection cooling (no forced cooling)
- Ambient temperature range during operation -25...+70 °C
- Open-circuit, overload and short-circuit stable
- Integrated input fuse
- DC OK - signaling output "13-14" (Relay), Power reserve signaling output " $I > I_R$ " (Transistor)
- Redundancy unit CP-A RU offering true redundancy, available as accessory
- Approvals / Marks (depending on device, partly pending):



Benefits

Power reserve

The primary switch mode power supply CP-C.1 is equipped with a power reserve to handle particularly heavy loads for example during the start-up of a process or a motor. The CP-C.1 will deliver up to 50 % of the rated current to secure the operation of the application also on heavy loads. This status is indicated by the yellow LED giving a clear visual status of the operation mode.

Signaling output

A signaling output relay is part of the CP-C.1 power supply. A transistor output switches to show that the device is now running on power reserve mode. This signaling could be used as a way to communicate to a higher level control system e.g. a PLC. The CP-C.1 includes an output relay to indicate the status of the voltage (OUTPUT OK). Depending on the logic of the higher level control system an appropriate action is initiated by forwarding the signal. The receptor of this signal could be a contactor, a signal tower or an interface relay.



Continuous operation

- Power reserve design to allow performance with up to 50 % more current
- Redundancy setup of the application possible to allow parallel operation
- Long lifetime
- High peak currents for switching on capacitive loads are supported



Project cost reduction

- Up to 94 % efficiency saves money for energy during operation
- Less need for external cooling in the cabinet
- Small size to reduce space needed in panel



Harsh environment

- Applicable in environments from -25 to +70°C
- High MTBF values

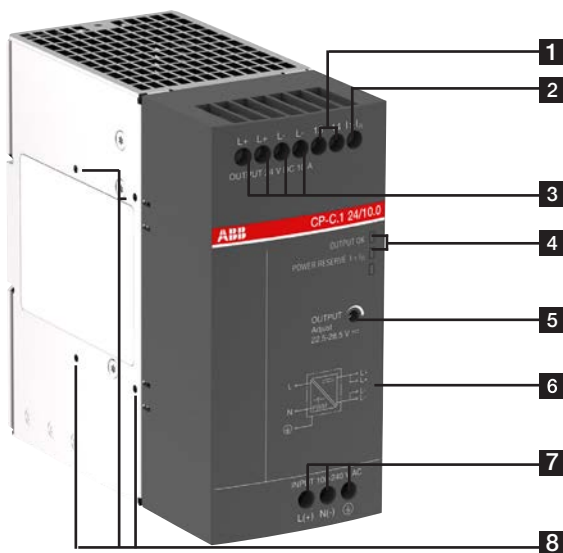

- 1 13-14: Relay output to signal output OK
- 2 $I > I_R$: Power reserve transistor output
- 3 OUTPUT L+, L-: Output terminals
- 4 Indication of operational states
OUTPUT OK: Green LED
POWER RESERVE $I > I_R$: Yellow LED
- 5 OUTPUT Adjust: Rotary potentiometer -
Adjustment of output voltage 22.5-28.5 V DC
- 6 Circuit diagram
- 7 INPUT L(+), N(-), o/PE: Input terminals
- 8 Side mounting screw holes for DIN rail adapter / lateral mounting

CP-C.1 range

Ordering details



2CDC 271 003 F0014

CP-C.1 24/5.0



2CDC 271 003 V0015

CP-C.1 24/10.0



2CDC 271 004 V0015

CP-C.1 24/20.0

Description

The CP-C.1 power supplies are ABB's high-performance and most advanced range. With excellent efficiency, high reliability and innovative functionality it is prepared for the most demanding industrial applications. These power supplies have up to 50 % integrated power reserve and operate at an efficiency of up to 94 %. They are equipped with overheat protection and active power factor correction. Combined with a broad AC and DC input range and extensive worldwide approvals the CP-C.1 power supplies are the preferred choice for professional DC applications.

Ordering details - CP-C.1

Input voltage range	Rated output voltage / current	Type	Order code	Price 1 pce	Weight (1 pce) kg (lb)
100-240 V AC, 90-300 V DC	24 V DC / 5 A	CP-C.1 24/5.0	1SVR360563R1001		0.96 (2.11)
100-240 V AC, 90-300 V DC	24 V DC / 10 A	CP-C.1 24/10.0	1SVR360663R1001		1.07 (2.35)
100-240 V AC, 90-300 V DC	24 V DC / 20 A	CP-C.1 24/20.0	1SVR360763R1001		2.83 (6.23)



Further documentation CP-C.1 power supplies on www.abb.com

CP-C.1 range

Technical data

Data at $T_a = 25\text{ °C}$, $U_{in} = 3 \times 400\text{ V AC}$ and rated values, unless otherwise indicated

Type		CP-C.1 24/5.0	CP-C.1 24/10.0	CP-C.1 24/20.0
Input circuit - supply circuit				
Rated input voltage U_{in}		100-240 V AC		
Input voltage range	AC	85-264 V AC		
	DC	90-300V DC		
Rated frequency		DC, 50/60 Hz		
Frequency range		45-65Hz		
Typical power consumption		132 W	256 W	508 W
Typical input current	at 115 V AC	1.1 A	2.3 A	4.6 A
	at 230 V AC	0.6 A	1.2 A	2.3 A
Discharge current towards PE		< 3.5 mA		
Inrush current limiting	cold state	< 15 A	< 20 A	< 30 A
Hold-up time	at 115 V AC	min. 50 ms	min. 40 ms	min. 40 ms
	at 230 V AC	min. 50 ms	min. 40 ms	min. 40 ms
Internal input fuse		T4.0A, not exchangeable	T6.3A, not exchangeable	T12A, not exchangeable
Recommended backup fuse for wire protection at 1.5 mm ²		1 pole miniature circuit breaker ABB type S 200		
	characteristic	B or C		
	max. rating	16 A		
Power factor correction (PFC)		yes, active		
Transient overvoltage protection		yes, varistor		
Indication of operational states				
Output voltage	LED 'OUTPUT OK' (green)	ON	92 % adjusted U_{out}	
		Flashing	90 % adjusted U_{out}	
Power reserve	LED ' $I > I_R$ ' yellow	OFF	$I \leq I_R$	
		ON	$I > I_R$	
Output circuit - power output				
Rated output voltage		24 V DC		
Tolerance of the output voltage		± 1 %		
Adjustment range of the output voltage		22.5-28.5 V DC		
Rated output power		120 W	240 W	480 W
Rated output current I_R	-25 °C < T_a < 70 °C	5.0 A	10.0 A	20.0 A
Reserve output current	-25 °C < T_a < 40 °C	7.5 A continuously	15.0 A continuously	26.0 A continuously
Short-circuit current limit		7.6 A	15.5 A	27.7 A
Derating of the output current	60 °C < T_a < 70 °C	2.5 %/°C		3.5 %/°C
Deviation width of output voltage	load change statical 10-90%	< 1 %, class C acc. to IEC/EN 61204		
	dynamical 0-100%	< 5 %, class B acc. to IEC/EN 61204		
Control time	change of input voltage within the input voltage range	< 1 ms, class A acc. to IEC/EN 61204		
	at rated load	< 0.1 %, class A acc. to IEC/EN 61204		
Starting time after applying the supply voltage	at rated load	< 500 ms, class C acc. to IEC/EN 61204		
Rise time	at rated load	< 10 ms		
Fall time		< 20 ms		
Residual ripple and switching peaks	BW = 20 MHz	< 120 mVpp, class A acc. to IEC/EN 61204		
Parallel connection		yes, up to 5 devices, to enable redundancy and to increase power, current not symmetrical		
Series connection		yes, max. 2 devices to increase voltage		
Output circuit - No-load, overload and short-circuit behaviour				
Characteristic curve of output		U/I characteristic curve with power reserve		
Short-circuit protection		continuous short-circuit stability		
Short-circuit behaviour		current limiting		
Resistance to reverse feed		≤ 35 V DC		
Over temperature protection		protection by switch off in case of overtemperature (thermal protection), automatic restart		
Overload protection		constant current limitation		
No-load protection		continuous no-load stability		
Starting of capacitive loads		yes		
Signalling outputs - OUTPUT OK signalling output				
Type of output	13-14	relay, n/o contact		
ON (contact closed)		92 % adjusted U_{out}		
OFF (contact open)		90 % adjusted U_{out}		
Contact ratings		30 V AC - 0.5 A / 24 V DC - 1 A (resistive load)		
		5 V DC / 1 mA		
Signalling outputs - POWER RESERVE signalling output				
Type of output	$I > I_R$	transistor, short-circuit proof		
Active / ON (closed)		$I > I_R$		
OFF (open)		$I \leq I_R$		
Ratings	voltage / current	24 V DC / ≤ 20 mA		

CP-C.1 range

Technical data

Type		CP-C.1 24/5.0	CP-C.1 24/10.0	CP-C.1 24/20.0
General data				
Efficiency	at rated output power	up to 93 %	up to 94 %	up to 94 %
Power losses	at rated output power	12 W	16 W	28 W
	at 50% of rated output power	8 W	12 W	17 W
	at no load	< 3.6 W		
Duty time		100 %		
MTBF	acc. to MIL 217 HDBK	on request		
Dimensions (W x H x D)		40.0 x 129.4 x 136.0 mm (1.575 x 5.094 x 5.354 in)	60.0 x 129.4 x 136.0 mm (2.36 x 5.094 x 5.354 in)	82.0 x 129.4 x 136.0 mm (3.23 x 5.094 x 5.354 in)
Weight		"Ordering details" on page 222.		
Minimum distance to other units	horizontal / vertical	max. 25 mm (0.98 in)		
Degree of protection	housing / terminals	max. 25 mm (0.98 in)		
Material of housing	cover / housing shell / front	zinc-coated sheet-steel / aluminium / plastic, PA6, V-0		
Mounting		DIN rail (EN 60715), snap-on mounting without any tool		
Mounting position		see data sheet		
Degree of protection (IEC/EN 60529)	enclosure / terminals	IP20 / IP20		
Protection class (EN 61140)		I		
Electrical connection - Input circuit, Output circuit, Signalling output				
Wire size		see data sheets		
Stripping length		see data sheets		
Tightening torque		see data sheets		
Environmental data				
Ambient temperature range	operation	-25...+70 °C (-13 ... +158 °F)		
	rated output power	-25...+60 °C (-13 ... +140 °F)		
	storage	-40...+85 °C (-40 ...+185 °F)		
	transport	-40...+85 °C (-40 ...+185 °F)		
Climatic category (IEC/EN 60721-3-1)	storage	1K2 (-40...+85 °C / -40...+185 °F)		
Climatic category (IEC/EN 60721-3-2)	transportation	2K2 (-40...+85 °C / -40...+185 °F)		
Climatic category (IEC/EN 60721-3-3)	operation	3K3 (-25...+70 °C / -13 ... +158 °F)		
Damp heat, cyclic (IEC/EN 60068-2-30)		Test Db: 55°C, 2 cycles		
Vibration, half-sine (IEC/EN 60068-2-6)		Test Fc: 10-58 Hz, amplitude ±0.15 mm, 58-150 Hz, 2 g, 10 sweep cycles each axis		
Shock, half-sine (IEC/EN 60068-2-27)		Test Ea: 30 g, 6 ms, 3 pulses each axis, bump 20 g, 11 ms, 100 pulses each axis		
Altitude	without restriction	2000 m		
Isolation data				
Rated impulse withstand voltage U _{imp} (EN 50178)	input circuit / output circuit	4 kV (1.2/50 µs)		
	input circuit / PE	4 kV (1.2/50 µs)		
	input circuit / relay contact	4 kV (1.2/50 µs)		
	output circuit / relay contact	0.5 kV (1.2/50 µs)		
	relay contact / PE	0.5 kV (1.2/50 µs)		
Rated insulation voltage U _i (EN 50178)	output circuit / PE	0.5 kV (1.2/50 µs)		
	input circuit / output circuit	300 V		
	input circuit / PE	300 V		
	input circuit / relay contact	300 V		
	output circuit / relay contact	50 V		
Overvoltage category (EN 50178)	relay contact / PE	50 V		
	output circuit / PE	50 V		
	< 2000m	III		
	2000...5000m	II		
	< 2000m	II		
Pollution degree (IEC/EN 60950-1; EN 50178)	2000...5000m	I		
Test voltage, type test (IEC/EN 60950-1)	input circuit / output circuit	4.24 kV DC		
	input circuit / PE	2.12 kV DC		
	relay contact / output circuit	0.707 kV DC		
	output circuit / PE	0.707 kV DC		
	Test voltage, routine test	input circuit / output circuit	1.5 kV AC	
	input circuit / PE	1.5 kV AC		
	relay contact / output circuit	1.5 kV AC		
	output circuit / PE	0.5 kV DC		
Protective separation (IEC/EN 60950-1)	input circuit / output circuit	Yes		
	input circuit / relay contact	Yes		
Standards				
Product standard		IEC/EN 61204		
Low Voltage Directive		2014/35/EC		
EMC Directive		2014/30/EC		
RoHS directive		2011/65/EC		
Electrical safety		IEC/EN 60950-1		
Industrial control equipment		UL 508 / CSA 22.2 No 107.1		
Electronic equipment for use in power installations		EN 50178		
Safety extra low voltage		PELV (EN 50178)		
Protective extra low voltage		SELV (IEC/EN 60950-1)		
Limitation of harmonic line currents		IEC/EN 61000-3-2		

CP-C.1 range

Technical data

3

Type		CP-C.1 24/5.0	CP-C.1 24/10.0	CP-C.1 24/20.0
Electromagnetic compatibility				
Low-voltage power supplies, d.c. output – Part 3: Electromagnetic compatibility (EMC)		IEC/EN 61204-3		
Interference immunity to		IEC/EN 61000-6-1 and IEC/EN 61000-6-2		
electrostatic discharge (ESD)	IEC/EN 61000-4-2	Level 4, 8kV / 15 kV		
radiated, radio-frequency, electromagnetic field	IEC/EN 61000-4-3	Level 3, 10 V/m		
electrical fast transient / burst	IEC/EN 61000-4-4	Level 3, 2 kV	Level 4, 4 kV	Level 4, 4 kV
surge	IEC/EN 61000-4-5	Level 3, L-N 2 kV , Level 4: L/N-PE 4 kV		
conducted disturbances, induced by radio-frequency fields	IEC/EN 61000-4-6	Level 3, 10 V		
Testing and measurement techniques – Power frequency magnetic field immunity test	IEC/EN 61000-4-8	30 A/m (A)	30 A/m (A) [1000 A/m succesfull tested]	30 A/m (A)
damped oscillatory magnetic fields	IEC/EN 61000-4-10	-	Level 4, 30 A/m	-
voltage dips, short interruptions and voltage variations immunity tests	IEC/EN 61000-4-11	Class 3		
voltage variations harmonics and interharmonics	IEC/EN 61000-4-13	-	Class 3	-
conducted, common mode disturbances in the frequency range 0 Hz to 150 kHz	IEC/EN 61000-4-16	-	Level 3, 10 V	-
Interference emission		IEC/EN 61000-6-3 and IEC/EN 61000-6-4		IEC/EN 61000-6-4
limits for harmonic current emissions	IEC/EN 61000-3-2	Class A		
limitation of voltage changes ect.	IEC/EN 61000-3-3	compliant		-
Information technology equipment radio disturbance characteristics limits and methods of measurement	IEC/CISPR 22, EN 55022	Class B		Class A
industrial scientific and medical (ISM) radio-frequency equipment electromagnetic disturbance characteristics limits and methods of measurement	IEC/CISPR 11, EN 55011	Class B		Class A
Voltage sags	SEMI F47	passed		
Federal Communications Commission	FCC15	compliant		

CP-C.1 range

Technical diagrams

Efficiency diagrams CP-C.1 24/5.0

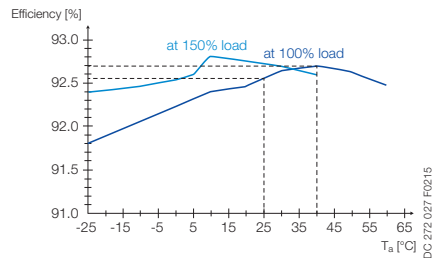
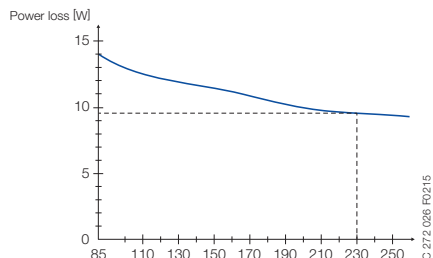
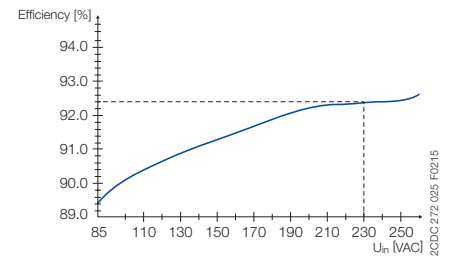
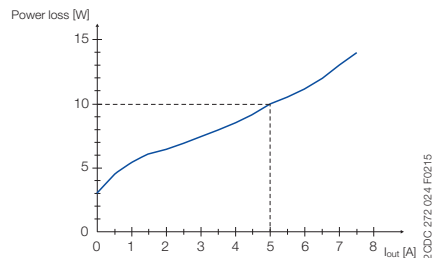
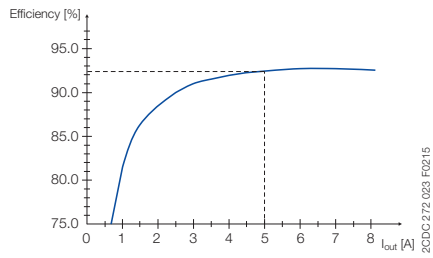

Typical power loss over AC input voltage

Typical efficiency over ambient temperature

Efficiency diagrams CP-C.1 24/10.0

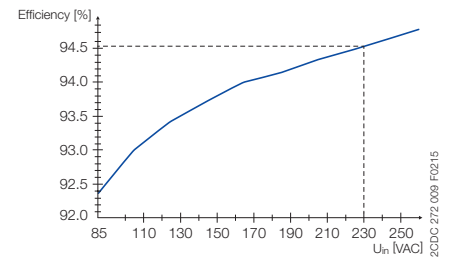
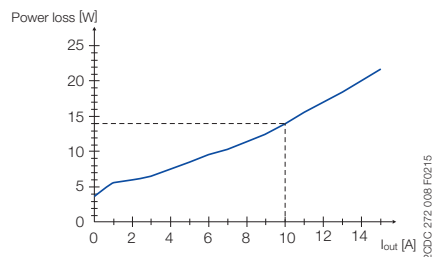
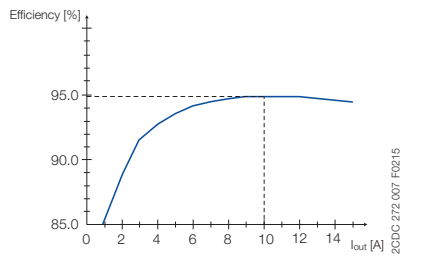

Typical efficiency over output current

Typical power loss over output current

Typical efficiency over AC input voltage

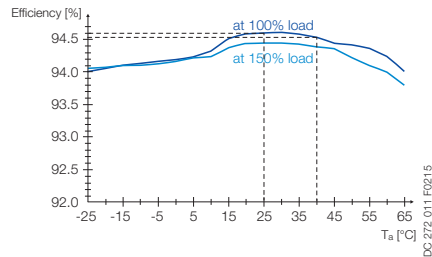
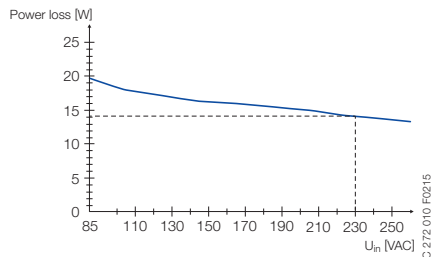

Typical power loss over AC input voltage

Typical efficiency over ambient temperature

CP-C.1 range

Technical diagrams, Dimensional drawings

Efficiency diagrams CP-C.1 24/20.0

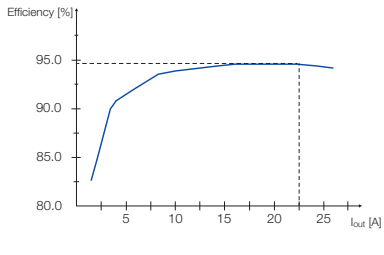

Typical efficiency over output current

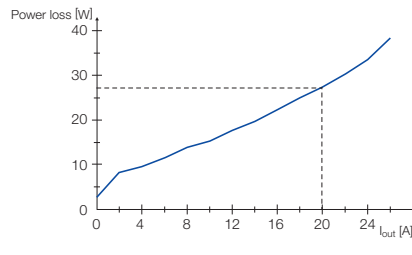

Typical power loss over output current

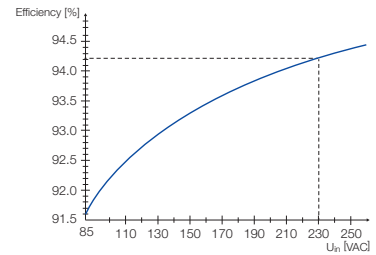

Typical efficiency over AC input voltage

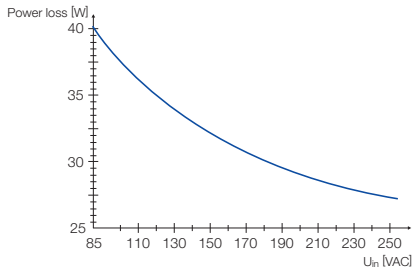

Typical power loss over AC input voltage

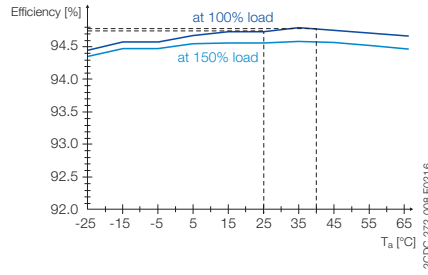

Typical efficiency over ambient temperature

Dimensional drawings dimensions in mm

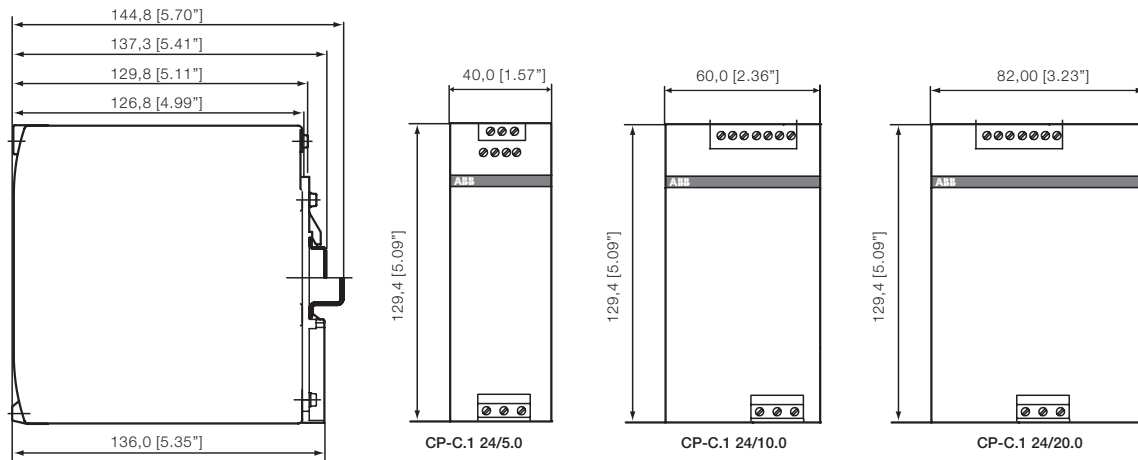

CP-C.1 range

Technical diagrams

Characteristic curve of output at $T_a = 25\text{ }^\circ\text{C}$

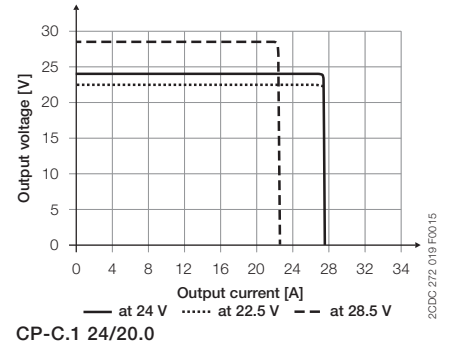
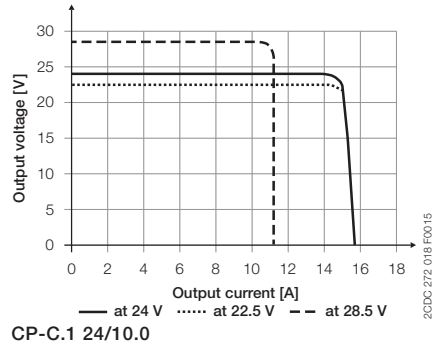
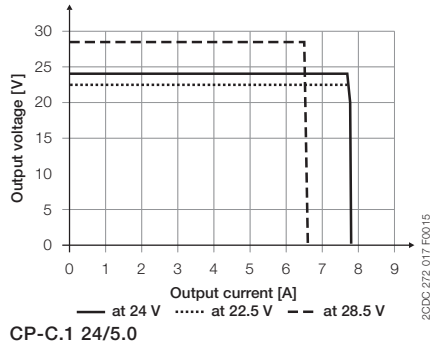

3

Characteristic curve of temperature at $U_{out} = 24\text{ V}$

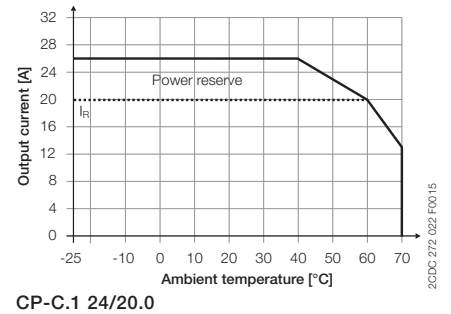
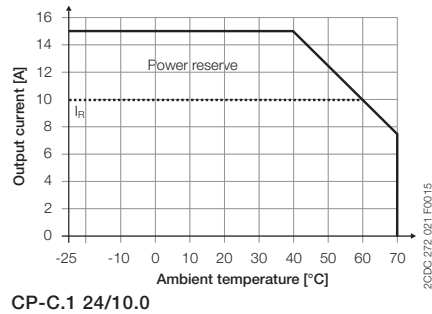
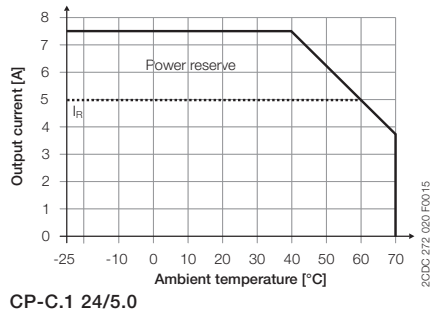

Redundancy units

Ordering details

3



CP-A RU + CP-A CM

2CDC 271 008 F0005

Description

Whenever the highest availability and reliability are the key requirement a true redundancy setup of two power supplies is the solution which means two power supplies are connected to a redundancy unit. In case one power supply fails, the other one keeps supplying the load. Furthermore, even short-circuit in one power supply will not affect the other one which keeps supplying the load. Additionally, the CP-A RU redundancy module can be equipped with a control module (CP-A CM) to monitor both inputs for undervoltage and react accordingly by switching an output relay.

Ordering details

Description	Suitable for decoupling of two 24 V DC power supply units	Type	Order code	Price 1 pce	Weight (1 pce) kg (lb)
2 inputs each up to 20 A and 1 output up to 40 A	≤ 40 V and ≤ 40 A	CP-A RU	1SVR427071R0000		0.89 (1.96)
Control module for CP-A RU redundancy units	-	CP-A CM	1SVR427075R0000		0.063 (0.14)
2 inputs each up to 2.5 A and 1 output up to 5 A	≤ 35 V and < 5 A	CP-RUD	1SVR423418R9000		0.15 (0.33)



CP-A RU

2CDC 271 010 F0006

Ordering details - CP-D RU for decoupling of two CP-D power supply units

Input voltage range	Rated input current	Rated output voltage / current	Type	Order code	Price	Weight (1 pce) kg (lb)
9-35 V DC	2 x 5 A	24 V DC / 1 x 10 A	CP-D RU	1SVR427049R0000		0.075 (0.165)



CP-RUD

2CDC 271 008 F0003



CP-D RU

2CDC 271 010 F0006



Further documentation of redundancy units on www.abb.com

Redundancy units

Technical data

Type	CP-A RU		CP-A RU in combination with CP-A CM
Input circuit - Supply circuit	(+/-, +/-)		
Rated input voltage U_{in}	24 V DC		
Input voltage range per channel	10-28 V DC	13-28 V DC	
Rated input current I_{in} per channel	1-20 A		
Maximum input current per channel	30 A for 300 s		
Transient overvoltage protection	yes		
Output circuit	(++/-)		
Rated output voltage U_{out}	24 V DC		
Voltage drop	typ. 0.6 V, max. 0.9 V		
Rated output current I_{out}	1-40 A		
Output ratings per channel	$T_a = 60\text{ °C}$	10-28 V DC / 40 A	13-28 V DC / 40 A
	$T_a = 70\text{ °C}$	10-28 V DC / 30 A	13-28 V DC / 30 A
Derating	$60\text{ °C} < T_a \leq 70\text{ °C}$	2.5 % per Kelvin temperature increase	
Peak output current	60 A for 300 s		
Resistance to reverse feed	< 40 V		
General data			
Dimensions (W x H x D)	56.5 (60 ¹⁾) x 130 x 135.5 mm; (2.22 (2.36 ¹⁾) x 5.12 x 5.35 in)		
Weight	0.89 kg (1.96 lb)		
Minimum distance to other units	horizontal / vertical	10 mm / 50 mm (0.39 in / 1.97 in)	
Degree of protection	housing / terminals	IP20 / IP20	
Material of housing	housing shell / cover	aluminium / zinc-coated sheet steel	
Protection class		III ²⁾	
Mounting		DIN rail (IEC/EN 60715)	
Mounting position		horizontal	
Electrical connection - Input circuit / Output circuit			
Wire size	fine-strand with wire end ferrule	2.5-10 mm ² (14-8 AWG)	
	fine-strand without wire end ferrule	0.5-10 mm ² (20-8 AWG)	
	rigid	0.5-16 mm ² (20-6 AWG)	
Stripping length		12 mm (0.47 in)	
Tightening torque		1.2-1.5 Nm	
Environmental data			
Ambient temperature range	operation	-25...+70 °C	
	rated load	-25...+60 °C (without derating)	
	storage	-40...+85 °C	
Damp heat (IEC/EN 60068-2-3)		93 % at 40 °C, no condensation	
Climatic category (IEC/EN 60721)		3K3	
Vibration (IEC/EN 60068-2-6)			
Shock (IEC/EN 60068-2-27)			
Isolation data			
Insulation voltage	between input / output / housing	500 V AC (routine test)	
Pollution degree (EN 50178)		2	
Standards			
Product standard		IEC/EN 61204	
Low Voltage Directive		2006/95/EC	
EMC Directive		2004/108/EC	
Electrical safety		EN 50178, EN 60950, UL 60950, UL 508	
Electromagnetic compatibility			
Interference immunity to		IEC/EN 61000-6-2	
electrostatic discharge	IEC/EN 61000-4-2	Level 3 (air discharge ±8 kV, contact discharge ±6 kV)	
radiated, radio-frequency, electromagnetic field	IEC/EN 61000-4-3	Level 3 (10 V/m)	
electrical fast transient / burst	IEC/EN 61000-4-4	Level 3 (±2 kV)	
surge	IEC/EN 61000-4-5	Level 1 (±0.5 kV)	
conducted disturbances, induced by radio-frequency fields	IEC/EN 61000-4-6	Level 3 (10 V)	
Interference emission		IEC/EN 61000-6-3	
high-frequency radiated	IEC/CISPR 22 / EN 55022	Class B	
high-frequency conducted	IEC/CISPR 22 / EN 55022	Class B	

¹⁾ incl. lateral screw

²⁾ This device is designed for connection to a safety extra-low voltage source. If no safety extra-low voltage is used at the input side, the lateral screw can be used for grounding of the housing (protection class I).

Redundancy units

Technical data

3

Type	CP-A CM	
Input circuit - Supply circuit		
Rated input voltage U_{in}	24 V DC	
Input voltage range	13-28 V DC	
Rated input current	at rated sense load and 24 V DC 120 mA	
Power consumption	at 24 V DC approx. 1 W	
Measuring circuit		
11-12/14, 21-22/24		
Monitoring function	undervoltage monitoring	
Measuring voltage	rated operational voltage	
Thresholds	14-28 V	
Hysteresis, related to the threshold value	fix: 3-5 %	
Accuracy, tolerance	10 % of full-scale value	
Maximum measuring cycle	6 ms	
Indication of operational states		
Status of input 1	IN 1: green LED	L: voltage at input 1 > than threshold 1 = no faults present
Status of input 2	IN 2: green LED	L: voltage at input 2 > than threshold 2 = no faults present
Output status	OUT: green LED	L: $U_{OUT} > 3 V$ = no faults present
+, +, -		
Output circuit		
Kind of output	relays, 2 x 1 c/o contact	
Contact material	AgNi	
Operating principle	closed-circuit principle	
Rated operational voltage U_e (IEC/EN 60947-1, VDE 0110)	250 V	
Minimum switching voltage / Minimum switching current	24 V / 10 mA	
Maximum switching voltage / Maximum switching current	250 V / 1 A	
Rated operational current I_e (IEC/EN 60947-5-1)	AC-12 (resistive) at 230 V	1 A
	AC-15 (inductive) at 230 V	1 A
	DC-12 (resistive) at 24 V	1 A
	DC-13 (inductive) at 24 V	1 A
Mechanical lifetime	30 x 10 ⁶ switching cycles	
Electrical lifetime	0.1 x 10 ⁶ switching cycles	
Rating according UL 508	General purpose (GP) 250 V AC	1 A
Maximum fuse rating to achieve short-circuit protection	n/o contact	2 A, gL
	n/c contact	2 A, gL
Sense output (+, +, -)		
Sense output voltage	13-28 V DC	
Sense output current	0.1 A	
Maximum fuse rating	For applications acc. UL the sense output shall be provided with a listed DC fuse 3 A	
General data		
Duty time	100 %	
Dimensions (W x H x D, when mounted)	56.5 x 54 x 24 mm (2.22 x 2.13 x 0.94 in)	
Material of housing	plastic	
Weight	0.063 kg (0.14 lb)	
Degree of protection	housing / terminals	IP20 / IP20
Protection class	II	
Mounting	snap-on mounting, without any tool	
Mounting position	plugged onto the redundancy unit CP-A RU	
Electrical connection		
Wire size	fine-strand with wire end ferrule	0.2-2.5 mm ² (24-14 AWG)
	fine-strand without wire end ferrule	
	rigid	0.2-4 mm ² (24-12 AWG)
Stripping length	7.5 mm (0.3 in)	
Tightening torque	0.4-0.6 Nm	
Isolation data		
Rated insulation voltage U_i (IEC/EN 60947-1, EN 50178, VDE 0160)	250 V	
Rated impulse withstand voltage U_{imp} (type test) between all circuits (IEC 664, VDE 0110)	2.5 kV	
Power-frequency withstand voltage test (routine test) between all circuits	1.2 kV AC	
Protective separation (EN 50178) between input and output	yes	
Pollution degree	2	
Overvoltage category	II	
Environmental data		
Ambient temperature range	operation	-25...+70 °C
	storage	-40...+85 °C
Damp heat (IEC/EN 60068-2-3)	93 % at 40 °C, no condensation	
Climatic category (IEC/EN 60721)	3K3	
Vibration (IEC/EN 60068-2-6)		
Shock (IEC/EN 60068-2-27)		

Redundancy units

Technical data

Type		CP-RUD
Input circuit - Supply circuit		A: U1+/-U ; B: U2+/-U
Rated input voltage U_{in}		24 V DC
Input voltage range		5-35 V DC
Rated input current I_{in} per channel		0.5-2.5 A
Maximum input current per channel		10 A for 300 s
Transient overvoltage protection		no
Output circuit		L+, L+, L+, L-, L-, L-
Rated output voltage U_{out}		24 V DC
Voltage drop		typ. 0.6 V, max. 0.7 V
Rated output current I_{out}		0.5-5 A
Peak output current		20 A for 150 s
Resistance to reverse feed		< 35 V
General data		
Dimensions (W x H x D)		22.5 x 78 x 100 mm (0.89 x 3.07 x 4.02 in)
Weight		0.135 kg (0.30 lb)
Minimum distance to other units	horizontal / vertical	10 mm / 10 mm (0.39 in / 0.39 in)
Degree of protection	housing / terminals	IP20 / IP20
Material of housing	housing shell / cover	plastic / plastic
Protection class		-
Mounting		DIN rail (IEC/EN 60715)
Mounting position		horizontal
Electrical connection - Input circuit / Output circuit		
Wire size	fine-strand with wire end ferrule	2 x 0.75-2.5 mm ² (2 x 18-14 AWG)
	fine-strand without wire end ferrule	
	rigid	2 x 0.5-4 mm ² (2 x 20-12 AWG)
Stripping length		7 mm (0.28 in)
Tightening torque		0.6-0.8 Nm
Environmental data		
Ambient temperature range	operation	-20...+60 °C
	rated load	-20...+60 °C
	storage	-40...+85 °C
Damp heat (IEC/EN 60068-2-3)		93 % at 40 °C, no condensation
Climatic category (IEC/EN 60721)		-
Vibration (IEC/EN 60068-2-6)		
Shock (IEC/EN 60068-2-27)		
Isolation data		
Insulation voltage	between input / output / housing	-
Pollution degree (EN 50178)		2
Standards		
Product standard		
Low Voltage Directive		2006/95/EC
EMC Directive		2004/108/EC
Electrical safety		EN 50178
Electromagnetic compatibility		
Interference immunity to		IEC/EN 61000-6-2
electrostatic discharge	IEC/EN 61000-4-2	Level 3 (air discharge ±8 kV, contact discharge ±6 kV)
radiated, radio-frequency, electromagnetic field	IEC/EN 61000-4-3	Level 3 (10 V/m)
electrical fast transient/burst	IEC/EN 61000-4-4	Level 3 (±2 kV)
surge	IEC/EN 61000-4-5	Level 1 (±0.5 kV)
conducted disturbances, induced by radio-frequency fields	IEC/EN 61000-4-6	Level 3 (10 V)
Interference emission		IEC/EN 61000-6-3
high-frequency radiated	IEC/CISPR 22 / EN 55022	Class B
high-frequency conducted	IEC/CISPR 22 / EN 55022	Class B

¹⁾ incl. lateral screw

²⁾ This device is designed for connection to a safety extra-low voltage source. If no safety extra-low voltage is used at the input side, the lateral screw can be used for grounding of the housing (protection class I).

Redundancy units

Technical data

3

Type	CP-D RU	
Input circuit - Supply circuit	IN 1 + + -, IN 2 + + -	
Rated input voltage U_{in}	24 V DC	
Input voltage range	9-35 V DC	
Rated input current I_{in} per channel	5 A	
Maximum input current per channel	10 A for 300 s	
Transient overvoltage protection	no	
Output circuit	OUT + + +, - - -	
Rated output voltage U_{out}	24 V DC	
Voltage drop	typ. 0.5 V	
Rated output current I_{out}	10 A	
Resistance to reverse feed	< 35 V	
General data		
MTBF	on request	
Duty time	100 %	
Dimensions (W x H x D)	product dimensions	35 x 91 x 56.5 mm (1.38 x 3.58 x 2.22 in)
	packaging dimensions	134 x 94 x 48 mm (5.28 x 3.70 x 1.89 in)
Weight	net weight	0.075 kg (0.165 lb)
	gross weight	0.130 kg (0.286 lb)
Material of housing	plastic	
Mounting	DIN rail, snap-on mounting without any tool	
Mounting position	horizontal	
Minimum distance to other units	horizontal / vertical	25 mm (0.98 in) / 25 mm (0.98 in)
Electrical connection - Input circuit / Output circuit		
Wire size	fine-strand with (out)wire end ferrule	0.2-2.5 mm ² (24-14 AWG)
	rigid	0.2-2.5 mm ² (24-12 AWG)
Stripping length	7.0 mm (0.28 in)	
Tightening torque	0.67 Nm (6 lb.in)	
Environmental data		
Ambient temperature range	operation	-40...+70 °C
	storage	-40...+85 °C
Relative humidity	RH at 40 °C	20-95 %, no condensation
Vibration (IEC/EN 60068-2-6)	Mounting by rail: 10-500 Hz, 2 G, along X, Y, Z each axis, 60 min for each axis	
Shock (IEC/EN 60068-2-27)	15 G, 11 ms, 3 axis, 6 faces, 3 times for each face	
Standards		
Product standard	IEC/EN 61204-3	
Low Voltage Directive	2006/95/EC	
EMC Directive	2004/108/EC	
RoHS Directive	2011/65/EC	
Electromagnetic compatibility		
Interference immunity to	EN 55024	
electrostatic discharge	IEC/EN 61000-4-2	Level 3, air discharge 8 kV, contact discharge 4 kV
radiated, radio-frequency, electromagnetic field	IEC/EN 61000-4-3	Level 3, 10 V/m
electrical fast transient/burst	IEC/EN 61000-4-4	Level 3, 2 kV / 5 kHz
conducted disturbances, induced by radio-frequency fields	IEC/EN 61000-4-6	Level 3, 10 V
Interference emission	EN 55022	
high-frequency radiated	IEC/CISPR 22 / EN 55022	Class B
high-frequency conducted	IEC/CISPR 22 / EN 55022	Class B

Redundancy units

Dimensional drawings

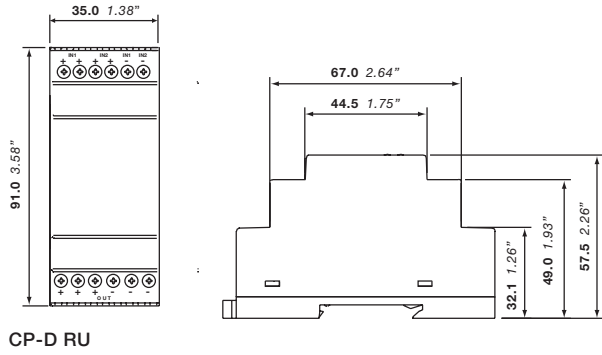

CP-D RU

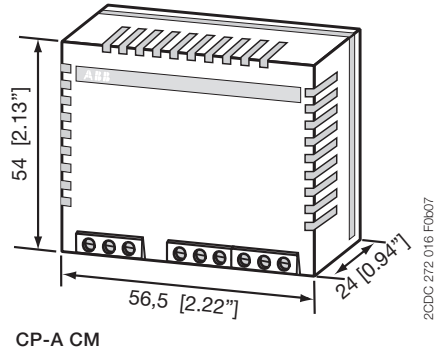

CP-A CM

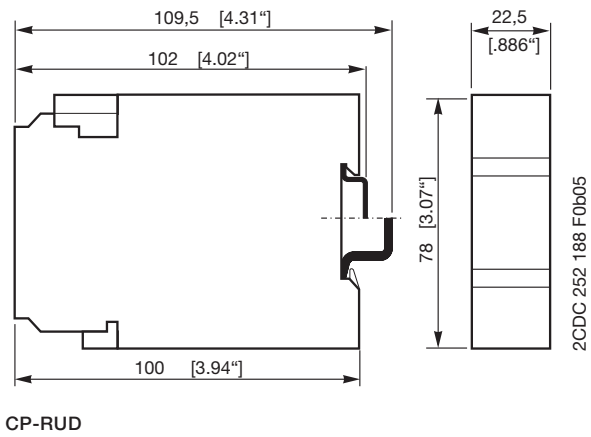

CP-RUD

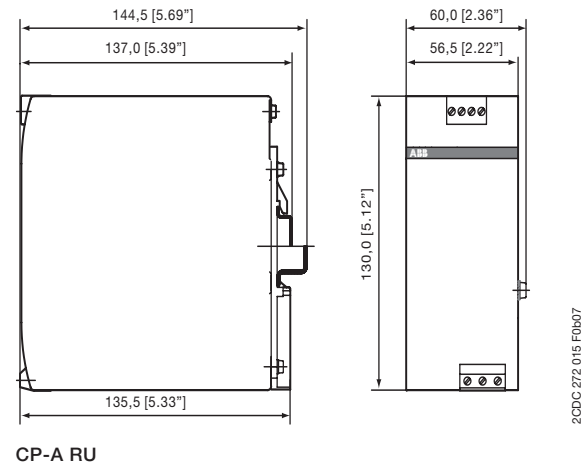

CP-A RU

CP-B range

Product group picture

3



CP-B range

Table of contents

CP-B

CP-B range	236
Table of contents	236
Benefits and advantages	237
Ordering details	238
Technical data	239
Technical data, Technical diagrams	240
Dimensional drawings	241

CP-B range

Benefits and advantages

Power supply systems have to be highly reliable in most areas of energy management and automation technology. Often batteries are used for supporting the supply system in case of mains failures. Batteries have limited lifetimes depending on environmental parameters and have to be maintained regularly, which causes efforts and costs.

3



Using the latest ultra-capacitor technology, ABB offers an innovative and completely maintenance free new product for buffering the 24 V DC supply in case of interrupted mains on the primary side of the switch mode power supply.

The CP-B range is an ultra-capacitor buffer energy storage for power supply units which ensures a short term uninterrupted power supply system. In case of a power loss, the energy stored in the capacitor guarantees that the load is continually provided up to several hundred seconds depending on the load current.

Characteristics

- 3 buffer modules for buffering 24 V DC:
 - CP-B 24/3.0 (3 A / 1 kW¹⁾)
 - CP-B 24/10.0 (10 A / 10 kW¹⁾)
 - CP-B 24/20.0 (20 A / 8 kW¹⁾)
- CP-B 24/3.0 and CP-B 24/20.0 expandable with additional extension module(s) CP-B EXT.2 (2 kW¹⁾)
- LEDs for status indication
- Relay contacts for status messaging
- Very high backup times (e.g. with CP-B 24/10.0 up to 8 minutes at 1 A load current)
- Short charging times
- High efficiency, higher than 90%
- Wide temperature range
- DIN rail mountable, compact housing
- Extended temperature range -40...60 °C

Advantages in comparison to battery buffers:

- Maintenance free
- No deep discharge
- Temperature resistant
-  (UL508, CSA22.2 No 14),  approvals

¹⁾ internal energy buffer

	CP-B 24/3.0	CP-B 24/10.0	CP-B 24/20.0	CP-B EXT.2
Order code	1SVR427060R0300	1SVR427060R1000	1SVR427060R2000	1SVR427065R0000
Rated input voltage	24 V DC	24 V DC	24 V DC	-
Rated current	3 A DC	10 A DC	20 A DC	3 A DC
Energy storage (min.)	1,000 Ws	10,000 Ws	8,000 Ws	2,000 Ws
Typical charging time at load current	100 %	65 s	134 s	
	0 %	56 s	82 s	
Typical buffering time ¹⁾ at load current	100 %	13 s	38 s	
	50 %	28 s	76 s	
	25 %	66 s	140 s	
	10 %	148 s	380 s	

¹⁾ buffering time ≈

$$\frac{\text{energy storage} \times 0.9}{\text{current} \times \text{output voltage}}$$



1 Input terminals

SHUT-DOWN+, SHUT-DOWN-: Input signal terminals
 INPUT OK, BUFFER STATUS, FAILURE: Signalling contact – terminals
 L_{IN}⁺, L_{IN}⁻: Input voltage terminals

2 Indication of operational states

OPERATION: Buffer module in operation (standby or buffering)
 INPUT OK: Input voltage applied

3 Output terminals

L_{OUT}⁺, L_{OUT}⁻, L_{OUT}⁺: Output voltage terminals

CP-B range Ordering details



CP-B 24/3.0

2CDC 271 001 S0010



CP-B 24/10.0

2CDC 271 002 S0010



CP-B 24/20.0

2CDC 271 003 S0010

Description

Ultra capacitor based buffer units of the CP-B range offer highest reliability also in harsh environment. Due to the ultra-cap based technology the units are maintenance free, there will be no deep discharge and these products offer a very wide operational ambient temperature range.

CP-B range buffer units are an excellent solution to avoid voltage drops, for example in solar applications.

Ordering details

Rated input voltage	Rated current	Type	Order code	Price 1 pce	Weight (1 pce) kg (lb)
24 V DC	3 A DC	CP-B 24/3.0	1SVR427060R0300		0.55 (1.21)
	10 A DC	CP-B 24/10.0	1SVR427060R1000		2.10 (4.63)
	20 A DC	CP-B 24/20.0	1SVR427060R2000		2.20 (4.85)

Ordering details - Extension unit for CP-B 24/3.0 and CP-B 24/20.0

Rated voltage	Voltage range	Type	Order code	Price 1 pce	Weight (1 pce) kg (lb)
24 V DC	0-26.4 V DC	CP-B EXT.2	1SVR427065R0000		1.00 (2.20)

Example of application

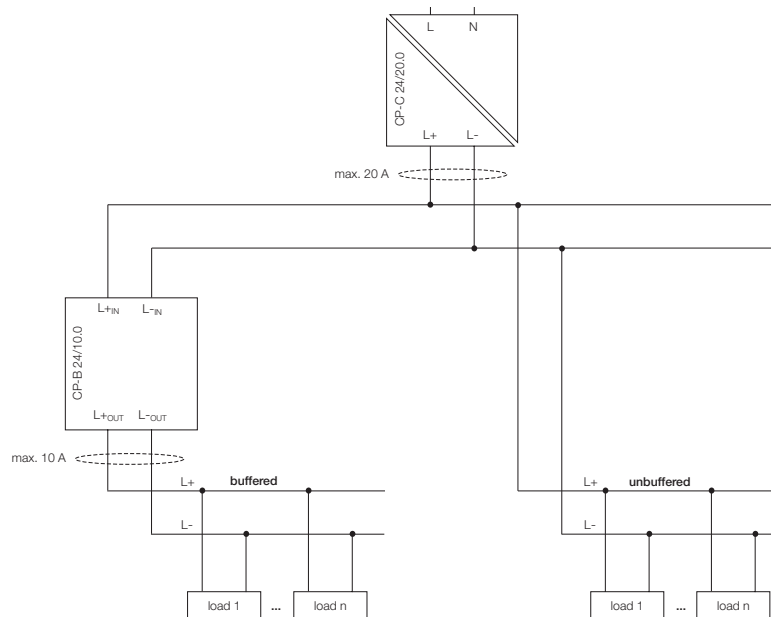

Further documentation CP-B power supplies on www.abb.com

CP-B range

Technical data

3

Type		CP-B 24/3.0	CP-B 24/10.0	CP-B 24/20.0
Input circuit - Supply circuit			L₊ L_{IN} L_{-IN}	
Rated input voltage U _{in}		24 V DC		
Input voltage range		23.7-26.4 V DC	23.9-27 V DC	23.4-27.4 V DC
Minimum charging potential		23.7 V DC	23.9 V DC	23.4 V DC
Rated input current		3 A DC	10 A DC	20 A DC
Inrush current limiting		50 A / 1 ms	35 A / 2 ms	35 A / 2 ms
Transient overvoltage protection		suppressor diode	varistor / suppressor diode	varistor / suppressor diode
Internal input fuse (apparatus protection, not accessible)		4 A slow acting	15 A (FK2)	30 A (FK2)
Internal fuse capacitors circuit (not accessible)			25 A (FK2)	
Kind of input	SHUT-DOWN	-	control input	control input
	rated voltage	-	24 V DC	24 V DC
	voltage range	-	6-45 V DC	6-45 V DC
Output circuit			L₊ L_{OUT} L_{-OUT} L_{-OUT}	
Rated output power		69 W	240 W	480 W
Rated output voltage U _{out}		24 V DC		
Output voltage (buffer mode)		23.0 V DC	23.2 V DC	23.2 V DC
Tolerance of the output voltage		+2...-10 %		
Rated output current I _r	Ta m 60 °C	3 A DC	10 A DC	20 A DC
Peak output current (fully loaded capacitors required)	Ta m 60 °C	6 A DC (min. 1.5 s)	20 A DC (10 A power supply + 10 A CP-B, min. 1.5 s)	40 A DC (min. 1.5 s)
Control of limiting current		-	10.3 A DC ±0.1A	-
Shut-down if limiting current is exceeded		-	after 1.5 s	-
Short-circuit protection (only via external fuse)		-	no continuous short-circuit stability	-
Internal output fuse (not accessible)		-	15 A (FK2)	-
Required external fuse		3.15 A slow acting	10 A slow acting	25 A slow acting
Current limiting at output circuit		-	1.05...1.2 x I _r	-
Breaking capacity of output circuit	t= 2.5 ms	-	24 V DC, 10 A	-
Power failure buffering time ¹⁾		load-dependent, min. 13 s at 100 % load	load-dependent, min. 38 s at 100 % load	load-dependent, min. 15 s at 100 % load
Overload protection		thermal protection		
Kind of output	INPUT OK	n/o contact		
	BUFFER STATUS	-	n/o contact	
	FAILURE	-	c/o contact	
Contact material		Ag + Au-clad		
Minimum switching voltage / Minimum switching current		5 V DC / 1 mA		
Maximum switching voltage / Maximum switching current		50 V AC / 1.0 A, 30 V DC / 0.5 A		
Mechanical lifetime		5 x 10 ⁶ switching cycles		
Electrical lifetime		0.1 x 10 ⁶ switching cycles		
Maximum fuse rating to achieve short-circuit protection	n/o or n/c contact	1.0 A AC / 0.5 A DC		
General data				
Maximum internal power consumption		7 W	20 W	40 W
Power consumption with unloaded output		0.75 W	3 W	1.6 W
Energy storage (min.)		1000 Ws	10000 Ws	8000 Ws
Typical charging time at load current	100 %	65 s	134 s	135 s
	0 %	56 s	82 s	62 s
Typical buffering time at load current ¹⁾	100 %	13 s	38 s	15 s
	50 %	28 s	76 s	30 s
	25 %	66 s	140 s	60 s
	10 %	148 s	380 s	150 s
Efficiency		greater than 90 %		
Dimensions (W x H x D)	product dimensions	60 x 99 x 120 mm (2.36 x 3.90 x 4.72 in)	116 x 170 x 147 mm (4.57 x 6.69 x 5.79 in)	84 x 197 x 213 mm (3.31 x 7.76 x 8.39 in)
Weight	net weight	0.55 kg (1.21 lb)	2.1 kg (4.63 lb)	2.2 kg (4.85 lb)
Material	cover / housing shell	steel sheet powdered		
Mounting		DIN rail (IEC/EN 60715), snap-on mounting without any tool		
Mounting position		horizontal		
Minimum distance to other units	horizontal	not necessary		
	vertical	40 mm (1.58 in)		80 mm (3.15 in)
Pollution degree		2		
Degree of protection	housing / terminal	IP20		
Protection class (IEC/EN 61140)		III SELV / PELV (condition: power supply fulfills class III)		
Electrical connection - Input circuit / Output circuit		pull spring terminals	pull spring terminals	pluggable screw type terminals
Wire size	fine-strand with(out) wire end ferrule	0.08-1.0 mm ² (28-18 AWG)	0.08-1.5 mm ² (28-18 AWG)	0.2-4.0 mm ² (24-12 AWG)
	rigid	0.08-1.5 mm ² (28-16 AWG)	0.08-4.0 mm ² (28-16 AWG)	0.2-6.0 mm ² (24-10 AWG)
Stripping length		6.0 mm (0.24 in)		7.0 mm (0.28 in)

CP-B range

Technical data, Technical diagrams

Type	CP-B 24/3.0	CP-B 24/10.0	CP-B 24/20.0
Input circuit - Supply circuit	L+ _{IN} L- _{IN}		
Signalling circuit			
Wire size	fine-strand with(out) wire end ferrule	0.08-1.0 mm ² (28-18 AWG)	0.14-1.0 mm ² (26-16 AWG)
	rigid	0.08-1.5 mm ² (28-16 AWG)	0.14-1.5 mm ² (28-16 AWG)
Stripping length	6.0 mm (0.24 in)		7.0 mm (0.28 in)
Environmental data			
Ambient temperature	operation	-40...+60 °C	
	storage	-40...+60 °C	
Standards			
Product standard	EN 50178		
Low Voltage Directive	2006/95/EC		
EMC Directive	2004/108/EC		
RoHS Directive	2011/65/EC		
Electrical safety	EN 50178, EN 60950, UL 508		
Electromagnetic compatibility			
Interference immunity to	IEC/EN 61000-6-1, IEC/EN 61000-6-2		
electrostatic discharge	IEC/EN 61000-4-2	Level 3, 6 kV / 8 kV	
radiated, radio-frequency, electromagnetic field	IEC/EN 61000-4-3	Level 3, 10 V/m (27-1000 MHz) / Level 2, 3 V/m (1400-2700 MHz)	
electrical fast transient/burst	IEC/EN 61000-4-4	Level 3, 2(1) kV / 5 kHz	
surge	IEC/EN 61000-4-5	Level 1, 0.5 kV	
conducted disturbances, induced by radio-frequency fields	IEC/EN 61000-4-6	Level 3, 10 V (150 kHz-80 MHz)	
voltage dips, short interruptions and voltage variations	IEC/EN 61000-4-11	buffered by ultra-capacitors	
Interference emission	EN 61000-6-3, EN 61000-6-4		
high-frequency radiated	DIN EN 55011	B/C1	
high-frequency conducted	DIN EN 55011	B/C1	

"Approvals and marks" on page 182

$${}^1) \text{ buffering time } \approx \frac{\text{energy storage} \times 0.9}{\text{load current} \times \text{output voltage}}$$

Technical diagrams

Output curve at $T_a = 25\text{ °C}$

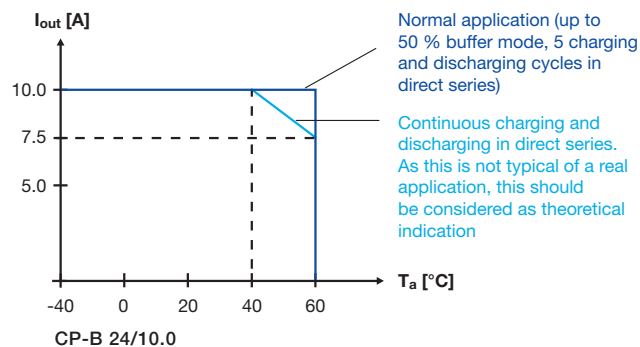
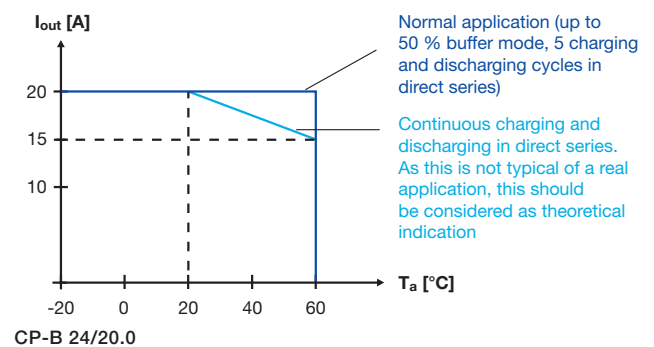
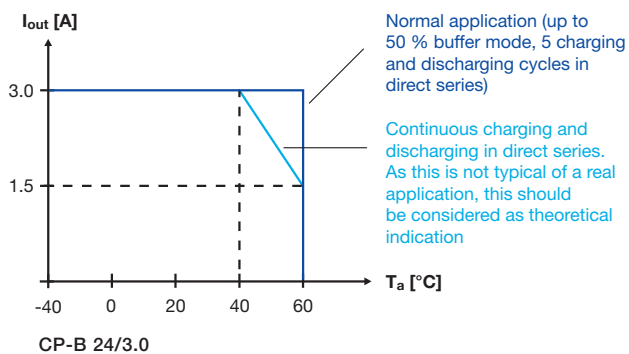

Characteristic curve of the temperature at rated load

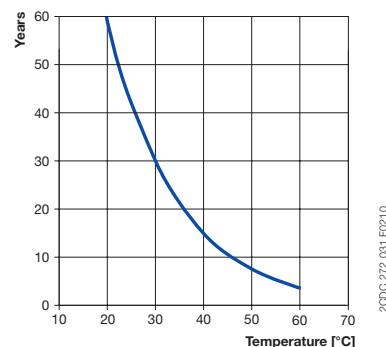

CP-B range

Dimensional drawings

Dimensions in mm and inches

3

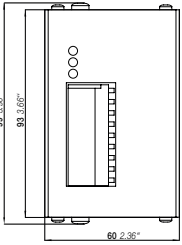

CP-B 24/3.0

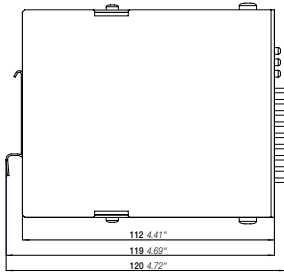

2CDC 272 037 F0010

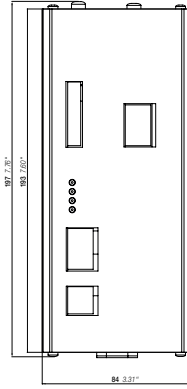

CP-B 24/20.0

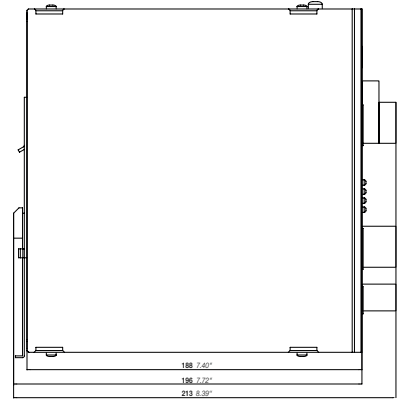

2CDC 272 039 F0010

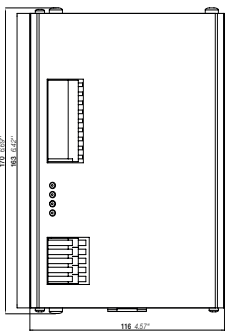

CP-B 24/10.0

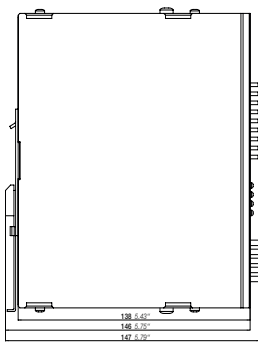

2CDC 272 038 F0010

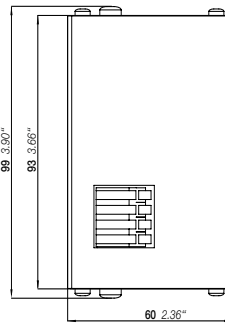

CP-B EXT.2

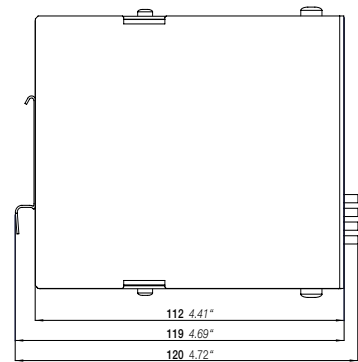

2CDC 272 038 F0010

CP-B range

Technical data

Data at $T_a = 25\text{ °C}$ and rated values, unless otherwise indicated

Type		CP-B EXT 2.0
Extension circuit		EXT+ EXT+ EXT- EXT-
Rated voltage		24 V DC
Voltage range		0-26.4 V DC
Rated current		3 A DC
Internal input fuse (apparatus protection, not accessible)		4 A slow acting (PTC)
Short-circuit protection		via internal 3 A fuse
Overload protection		only in combination with CP-B 24/3.0 or CP-B 24/20.0
Indication of operational states		status information and fault messages of the buffer module apply
General data		
Power consumption without load		0.5 W
Energy storage (min.)		2000 Ws
Dimensions (W x H x D)	product dimensions	60 x 99 x 120 mm (2.36 x 3.90 x 4.72 in)
	packaging dimensions	85 x 220 x 170 mm (3.35 x 8.66 x 6.69 in)
Weight	net weight	1.00 kg (0.20 lb)
Material	cover / housing shell	steel sheet powdered
Mounting		DIN rail (IEC/EN 60715), snap-on mounting without any tool
Mounting position		horizontal
Minimum distance to other units	horizontal	not necessary
	vertical	40 mm (1.58 in)
Pollution degree		2
Degree of protection	housing / terminal	IP20
Protection class (IEC/EN 61140)		III SELV / PELV (condition: power supply fulfills class III)
Electrical connection - Extension circuit		
Wire size	fine-strand with(out) wire end ferrule	0.08-1.0 mm ² (28-18 AWG)
	rigid	0.08-1.5 mm ² (28-16 AWG)
Stripping length		6.0 mm (0.24 in)
Signalling circuit		
Wire size	fine-strand with(out) wire end ferrule	0.08-1.0 mm ² (28-18 AWG)
	rigid	0.08-1.5 mm ² (28-16 AWG)
Stripping length		6.0 mm (0.24 in)
Environmental data		
Ambient temperature	operation	-40...+60 °C
	storage	-40...+60 °C
Vibration, sinusoidal	based on IEC/EN 60068-2-6	1.5 mm, 3-57.55 Hz; 2 g, 57.55-500 Hz, 10 cycles
Shock, half-sine	based on IEC/EN 60068-2-27	15 g, 11 ms, 3 axes, 6 faces, 3 times for each face
Standards		
Product standard		EN 50178
Low Voltage Directive		2006/95/EC
EMC Directive		2004/108/EC
RoHS Directive		2011/65/EC
Electrical safety		EN 50178, EN 60950, UL 508
Electromagnetic compatibility		
Interference immunity to		IEC/EN 61000-6-1, IEC/EN 61000-6-2
electrostatic discharge	IEC/EN 61000-4-2	Level 3, 6 kV / 8 kV
radiated, radio-frequency, electromagnetic field	IEC/EN 61000-4-3	Level 3, 10 V/m (27-1000 MHz) / Level 2, 3 V/m (1400-2700 MHz)
electrical fast transient/burst	IEC/EN 61000-4-4	Level 3, 2(1) kV / 5 kHz
surge	IEC/EN 61000-4-5	Level 1, 0.5 kV
conducted disturbances, induced by radio-frequency fields	IEC/EN 61000-4-6	Level 3, 10 V (150 kHz-80 MHz)
voltage dips, short interruptions and voltage variations	IEC/EN 61000-4-11	buffered by ultra-capacitors
Interference emission		EN 61000-6-3, EN 61000-6-4
high-frequency radiated	DIN EN 55011	B/C1
high-frequency conducted	DIN EN 55011	B/C1

"Approvals and marks" on page 182

Electronic protection devices EPD24

Product group picture

3



Electronic protection devices EPD24

Table of contents

Electronic protection devices EPD24

Electronic protection devices EPD24	244
Table of contents	244
Ordering details	245
Technical data	246
Technical information	248
Approvals, Safety instructions	249
Installation guidelines	250

Electronic protection devices EPD24

Ordering details

3



EPD24-TB-101-3A

2CDC 051 001 S0010

The protection devices EPD24 extend the ABB product range of Modular DIN rail components by electronic overcurrent protection modules for selective protection of 24 V DC load circuits.

This protection is achieved by a combination of active electronic current limitation in the case of a short circuit and an overload deactivation from $1.1 \times I_n$ upwards.

If a fault occurs in a load circuit, the protection device EPD24 will detect this rapidly and reliably, disable the power output transistor and hence interrupt the current flow in the defective circuit. The maximum possible overcurrent is always limited to $1.3 \dots 1.8$ times the selected rated current. An activation of capacitive loads up to $20,000 \mu\text{F}$ is possible, deactivation only occurring in the case of overloads or short circuits. Selective deactivation of the defective current circuit means undefined error states and a complete system stop are prevented.

Features

- Selective load protection, one electronic tripping characteristic.
- Active current limitation for safe connection of capacitive loads up to $20,000 \mu\text{F}$ and on overload/short circuit.
- Current ratings 0.5 A...12 A.
- Reliable overload disconnection with $1.1 \times I_N$
- Manual ON/OFF button
- Clear status and failure indication through LED and integrated auxiliary contact.
- Integral fail-safe element adjusted to current rating.
- Width per unit only 12.5 mm.
- Rail mounting
- Ease of wiring through busbar LINE+ and 0 V as well as signal bars.
- UL- and CSA-approvals allow international use of the devices.

Ordering details

Rated current I_N A	bbn 40 16779 EAN	Type	Order code	Price	Pkg qty	Weight (1 pce) kg (lb)
0.5	829960	EPD24-TB-101-0.5A	2CDE601101R2905		4	0.065 (1.433)
1	829984	EPD24-TB-101-1A	2CDE601101R2001		4	0.065 (1.433)
2	830003	EPD24-TB-101-2A	2CDE601101R2002		4	0.065 (1.433)
3	830027	EPD24-TB-101-3A	2CDE601101R2003		4	0.065 (1.433)
4	830041	EPD24-TB-101-4A	2CDE601101R2004		4	0.065 (1.433)
6	830065	EPD24-TB-101-6A	2CDE601101R2006		4	0.065 (1.433)
8	830089	EPD24-TB-101-8A	2CDE601101R2008		4	0.065 (1.433)
10	830102	EPD24-TB-101-10A	2CDE601101R2010		4	0.065 (1.433)
12	830126	EPD24-TB-101-12A	2CDE601101R2012		4	0.065 (1.433)

Ordering details

Description	bbn 40 16779 EAN	Type	Order code	Price	Pkg qty	Weight (1 pce) kg (lb)
Busbars for LINE+ and 0 V, grey insulation, length 500 mm ¹⁾	830140	EPD-BB500	2CDE605100R0500		10	0.2 (0.441)
Signal Bars for aux. contacts, grey insulation, length 21 mm	830164	EPD-SB21	2CDE605200R0021		10	0.4 (0.882)

¹⁾ Max. load with one line entry $I_{max} = 50$ A (recommended: mid line entry)
Max. load with two line entries $I_{max} = 63$ A

Electronic protection devices EPD24

Technical data

Wiring diagramm

EPD24-TB-101
without signal input
with signal output F
(Single signal, N/O)

Operating condition: 13-14 closed
Fault condition: 13-14 open

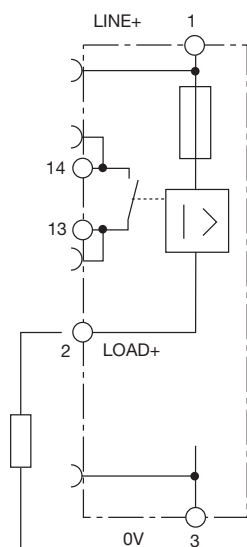

Operating data

Operating voltage U_B	24 V DC (18...32 V)
Current rating I_N	fixed current ratings: 0.5, 1, 2, 3, 4, 6, 8, 10, 12 A
Closed current I_0	ON condition: typically 20...30 mA depending on signal output
Status indication by means of	Green: unit is ON load circuit / Power-MOSFET is switched on Orange: in the event of overload or short circuit until electronic disconnection Red: unit electronically disconnected load circuit/Power-MOSFET OFF undervoltage ($U_B < 8$ V) after switch-on till the end of the delay period OFF: manually switched off or device is dead potential-free auxiliary contact F ON/OFF/ condition of switch

Load circuit

Load output	Power-MOSFET switching output (high side switch)
Overload disconnection	typically $1.1 \times I_N$ (1.05...1.35 $\times I_N$)
Short-circuit current I_k	active current limitation
Trip time	see time/current characteristics
For electronic disconnection	typically 3 s at $I_{Load} > 1.1 \times I_N$ typically 100 ms...3 s at $I_{Load} > 1.8 \times I_N$ (or $1.5 \times I_N / 1.3 \times I_N$)
Temperature disconnection	internal temperature monitoring with electronic disconnection
Low voltage monitoring load output	with hysteresis, no reset required: load »OFF« at $U_B < 8$ V
Starting delay t_{Start}	typically 0.5 sec after every switch-on and after applying U_B
Disconnection of load circuit	electronic disconnection
Free-wheeling circuit	suitable external free-wheeling circuit to be used with inductive load
Several load outputs must not be connected in parallel	

Signal output

Electrical data	potential-free auxiliary contact max. 30 V DC/0.5 A, min. 10 V DC/10 mA
ON condition LED green	voltage U_B applied, switch is in ON position no overload, no short circuit
OFF condition LED off	device switched off (switch is in OFF position) no voltage U_B applied
Fault condition LED orange	overload condition $> 1.1 \times I_N$ up to electronic disconnection
Fault condition LED red	electronic disconnection upon overload or short circuit Device switched off with control signal (switch is in ON position)
Aux. contact	single signal, make contact contact open, terminal 13-14
Fault	signal output fault conditions no operating voltage U_B ON/OFF switch is in OFF position red LED lighted (electronic disconnection)

Electronic protection devices EPD24

Technical data

3

General data	
Fail-Safe element	backup fuse for EPD24 not required because of the integral redundant fail-safe element
Housing material	moulded
Mounting	symmetrical rail to EN 50022-35x7.5
Ambient temperature	0...+50 °C (without condensation, see EN 60204-1)
Storage temperature	-20...+70 °C
Humidity	96 hrs/95 % RH/40 °C to IEC 60068-2-78, test Cab. climate class 3K3 to EN 60721
Vibration	3 g, test to IEC 60068-2-6 test Fc
Degree of protection	housing: IP20 DIN 40050 terminals: IP20 DIN 40050
EMC (EMC directive, CE logo)	emission: EN 61000-6-3 susceptibility: EN 61000-6-2
Isolations coordination (IEC 60934)	0.5 kV/pollution degree 2 reinforced insulation in operating area
Dielectric strength	max. 32 V DC (load circuit)
Isolation resistance (OFF condition)	n/a, only electronic disconnection
Approvals/Declarations of conformity	UL 2367 Solid State Overcurrent Protectors UL 1604, (class I, division 2, groups A, B, C, D) UL 508 CSA C22.2 No. 213 (class I, division 2) CSA C22.2 No. 142 CE logo
Dimensions (B x H x T)	12.5 x 80 x 83 mm
Weight	approx. 65 g
Terminals	Line+/LOAD+/0V
Screw terminals	M4
Max. cable cross section flexible with wire end ferrule w/wo plastic sleeve	0.5 – 10 mm ²
Multi-lead connection (2 identical cables) rigid/flexible	0.5 – 4 mm ²
Flexible with wire end ferrule without plastic sleeve	0.5 – 2.5 mm ²
Flexible with TWIN wire end ferrule with plastic sleeve	0.5 – 6 mm ²
Wire stripping length	10 mm
Tightening torque (EN 60934)	1.5 – 1.8 Nm
Terminals	aux. contacts
Screw terminals	M3
Max. cable cross section flexible with wire end ferrule w/wo plastic sleeve	0.25 - 2.5 mm ²
Wire stripping length	8 mm
Tightening torque (EN 60934)	0.5 Nm

Table 1: voltage drop, current limitation, max. load current

current rating I_N	typically voltage drop U_{ON} at I_N	active current limitation (typically)	max. load current at 100 % ON duty	
			$T_{ambient} = 40\text{ °C}$	$T_{ambient} = 40\text{ °C}$
0.5 A	70 mV	$1.8 \times I_N$	0.5 A	0.5 A
1 A	80 mV	$1.8 \times I_N$	1 A	1 A
2 A	130 mV	$1.8 \times I_N$	2 A	2 A
3 A	80 mV	$1.8 \times I_N$	3 A	3 A
4 A	100 mV	$1.8 \times I_N$	4 A	4 A
6 A	130 mV	$1.8 \times I_N$	6 A	5 A
8 A	120 mV	$1.5 \times I_N$	8 A	7 A
10 A	150 mV	$1.5 \times I_N$	10 A	9 A
12 A	180 mV	$1.3 \times I_N$	12 A	10.8 A

Attention: when mounted side-by-side without convection the ERD24 should not carry more than 80 % of its rated load with 100 % ON duty due to thermal effects.

Electronic protection devices EPD24

Technical information

Time/Current characteristic curve (T_{ambient} = 25 °C)

The trip time is typically 3 s in the range between 1.1 and 1.8 x I_N¹⁾

Electronic current limitation occurs at typically 1.8 x I_N¹⁾ which means that under all overload conditions (independent of the power supply and the resistance of the load circuit) the max. overload before disconnection will not exceed 1.8 x I_N¹⁾ times the current rating. Trip time is between 100 ms and 3 sec (depending on overload or at short circuit).

Without this current limitation a considerably higher overload current would flow in the event of an overload or short circuit.

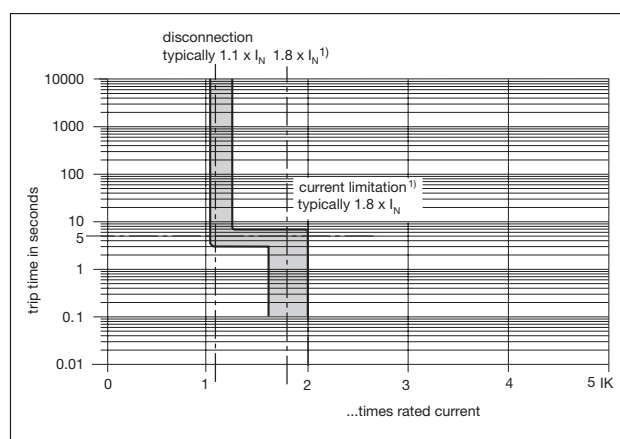

¹⁾ Current limitation typically 1.8 x I_N at I_N = 0.5 A...6 A
 Current limitation typically 1.5 x I_N at I_N = 8 A or 10 A
 Current limitation typically 1.3 x I_N at I_N = 12 A

Maximum cable lengths

EPD24 reliably trips from 0 Ω up to max. circuit resistance R_{max}.

Calculation of R_{max}

Selected rating I _N (A)	3	6
Operating voltage U _S (V DC) (= 80 % of 24 V) ²⁾	19.2	19.2
Trip current I _{ab} = 1.25 x I _N (A) (EPD24 trips after 3 s)	3.75	7.50
R _{max} (Ω) = (U _S /I _{ab}) - 0.050	5.07	2.51

²⁾ Voltage drop of EPD24 and tolerance of trip point (typically 1.1 x I_N = 1.05 ... 1.35 x I_N) have been taken into account

Selection table for the incoming cable lengths with different cable cross-sections

Cable cross section A (mm ²)	0.14	0.25	0.34	0.5	0.75	1.00	1.50
Cable length L (m) (= single length)	cable resistance (Ω) = (ρ ₀ x 2 x L) / A ³⁾						
5	1.27	0.71	0.52	0.36	0.24	0.18	0.12
10	2.54	1.42	1.05	0.71	0.47	0.36	0.24
15	3.81	2.14	1.57	1.07	0.71	0.53	0.36
20	5.09	2.85	2.09	1.42	0.95	0.71	0.47
25	6.36	3.56	2.62	1.78	1.19	0.89	0.59
30	7.63	4.27	3.14	2.14	1.42	1.07	0.71
35	8.90	4.98	3.66	2.49	1.66	1.25	0.83
40	10.17	5.70	4.19	2.85	1.90	1.42	0.95
45	11.44	6.41	4.71	3.20	2.14	1.60	1.07
50	12.71	7.12	5.24	3.56	2.37	1.78	1.19
75	19.07	10.68	7.85	5.34	3.56	2.67	1.78
100	25.34	14.24	10.47	7.12	4.75	3.56	2.37
125	31.79	17.80	13.09	8.90	5.93	4.45	2.97
150	38.14	21.36	15.71	10.68	7.12	5.34	3.56
175	44.50	24.92	18.32	12.46	8.31	6.23	4.15
200	50.86	28.48	20.94	14.24	9.49	7.12	4.75
225	57.21	32.04	23.56	16.02	10.68	8.01	5.34
250	63.57	35.60	26.18	17.80	11.87	8.90	5.93

³⁾ Resistivity of copper ρ₀ = 0.0178 (Ω x mm²)/m

Example 1: max. length for 1.5 mm² and 3 A: 214 m

Example 2: max. length for 1.5 mm² and 6 A: 106 m

Example 3: mixed wiring: (Control cabinet --- sensor/actuator level)

R1 = 40 m for 1.5 mm² and R2 = 5 m for 0.25 mm²:

R1 = 0.95 Ω, R2 = 0.71 Ω, total (R1 + R2) = 1.66 Ω

Electronic protection devices EPD24

Approvals, Safety instructions

Please note

The user must ensure that the cable cross sections of the relevant load circuit are suitable for the current rating of the EPD24 used. Automatic start-up of machinery after shut down must be prevented (Machinery Directive 98/37/EG and EN 60204-1). In the event of a short circuit or overload the load circuit will be disconnected electronically by the EPD24.

3

Information on UL approvals/CSA approvals



UL1604
UL File # E 339238



CSA C22.2 No. 213 (Class I, Division 2)
CSA File # 2305929

Operating Temperature Code T5

- This equipment is suitable for use in Class I, Division 2, Groups A, B, C and D or non-hazardous locations only

WARNING:

- Exposure to some chemicals may degrade the sealing properties of materials used in the following device: relay
Sealant Material:
 - Generic Name: Modified diglycidyl ether of bisphenol A
 - Supplier: Fine Polymers Corporation
 - Type: Epi Fine 4616L-160PK
- Casing Material:
 - Generic Name: Liquid Crystal Polymer
 - Supplier: Sumitomo Chemical
 - Type: E4008, E4009, or E6008

RECOMMENDATION:

- Periodically inspect the device named above for any degradation of properties and replace if degradation is found

WARNING – EXPLOSION HAZARD:

- Do not disconnect equipment unless power has been removed or the area is known to be non-hazardous
- Substitution of any components may impair suitability for Class I, Division 2

UL2367



Non-hazardous use - UL File # E 339236

UL 508



Non-hazardous use - UL File # E 149922

CSA C22.2 No. 14



CSA C22.2 No. 142 - CSA File # E 2305929

Class 2

Meets requirement for Class 2 current limitation (EPD24 ... -0,5 A/1 A/2 A/3 A)

Electronic protection devices EPD24

Installation guidelines

The EPD24 features an integral power distribution system.

The following wiring modes are possible with various pluggable current and signal busbars:

- LINE+ (24 V DC)
 - 0 V
- Caution: The electronic devices EPD24 require a 0 V connection
- Auxiliary contacts

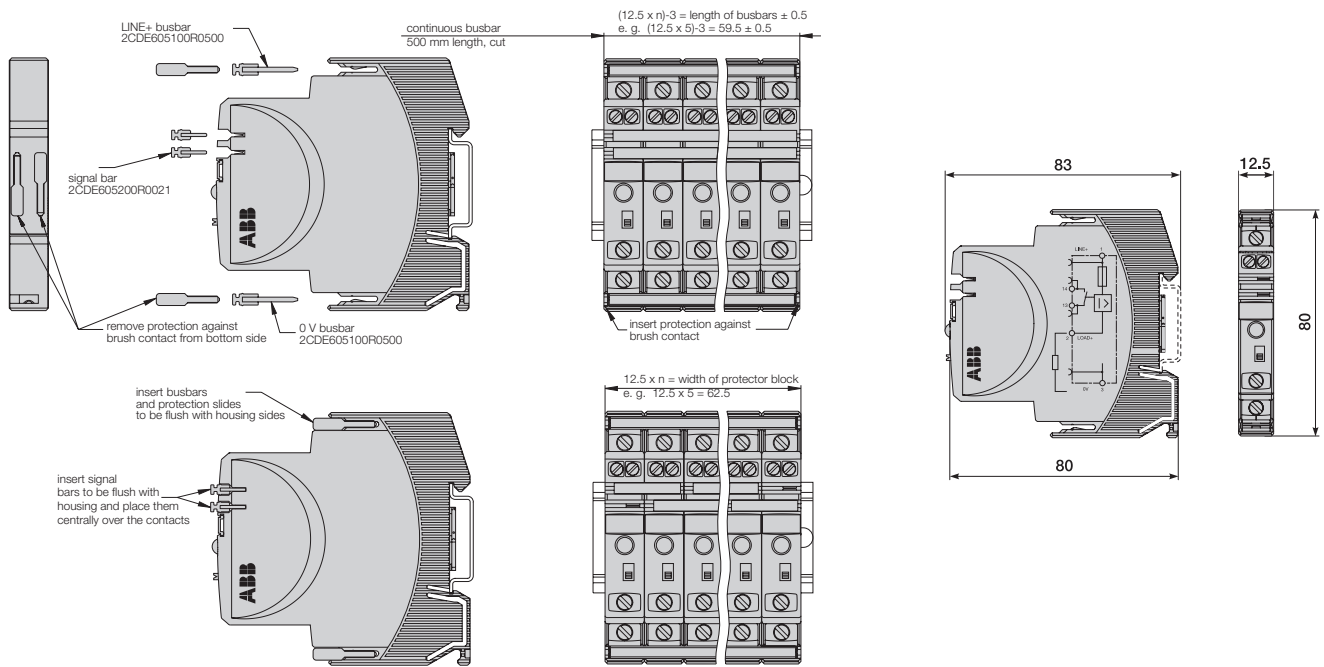

Mounting procedure

Before wiring insert busbars into protector block. A maximum of 10 connection cycles are permissible using connecting busbars.

Recommendation

After 10 units the busbars should be interrupted and receive a new entry live.

Table of length for busbars

(Order code 2CDE605100R0500)

No. of units	2	3	4	5	6	7	8	9	10
Length of busbar (mm) ± 0.5 mm	22	34.5	47	59.5	72	84.5	97	109.5	122

Analog signal converters

Product group picture

4



Analog signal converters

Table of contents

Analog signal converter

Analog signal converters	244
Table of contents	244
Overview	245
Overview	246
Analog signal converters - CC-E range	247
Benefits and advantages	247
Ordering details - Standard signal converters	248
Ordering details - Thermocouple converters	250
Ordering details - Measuring converters	251
DIP switch settings, Dimensional drawings	252
Wiring instructions	253
Technical data	254
Analog signal converters - CC-U range	257
Overview	257
Ordering details	259
Ordering details - Accessories	260
DIP switch settings	261
Wiring instructions	263
Technical information	264
Technical data	267
Technical diag., Connection diag., Dimensional drawings	270

Analog signal converters

Overview

CC-E range



- Universally configurable devices and single-function devices
- Adjustment and operating elements on the front side
- Safe operation by electrical 3-way isolation
- Unambiguous and clear connecting terminal markings

Conversion, measurement and separation of

- Standard signals (0-5 V, 0-10 V, 0-20 mA, 4-20 mA)
- Temperature signals of RTD sensors (PT 100)
- Thermocouple signals (types J and K)
- Current measurement signals (0-5 A, 0-20 A AC/DC)

Characteristics of single-function devices

- No adjustment or balancing necessary.

Characteristics of universal devices

- The required input and output ranges can be configured by means of directly accessible DIP switches positioned on the side
- Gain adjustment of $\pm 5\%$ by means of an adjustment potentiometer on the front-side
- Offset adjustment of $\pm 5\%$ by means of adjustment potentiometers on the front-side

CC-U range



- 8 different standard signal outputs on one device
- Input and output side universally configurable
- Also available with 2 threshold relay outputs
- Adjustment and operating elements on the front side
- Safe operation by electrical 3-way isolation
- Plug-in connecting terminals, unambiguously and clearly marked

Conversion, measurement and separation of

- Standard signals
- Signals of RTD sensors (PT10, PT100, PT1000)
- Thermocouple signals
- TRMS values of currents and voltages

Characteristics

- The required input and output ranges can be configured for all devices by means of directly accessible DIP switches positioned on the side.
- Due to the wide input range of the gain and offset stages all input signals between the minimum and the maximum input value can be universally converted to all common output signals.
- Devices for DC or AC (50/60 Hz) supply available.

- existing
- ▲ existing for some devices
- pending

		CC-E/STD	CC-E/I	CC-U/STD	CC-U/STDR	CC-E/RTD	CC-U/RTD	CC-E/TC	CC-U/TC	CC-U/TCR	CC-E/I	CC-E I _{AC} /ILPO	CC-U/I	CC-U/V
Approvals														
	UL 508, CAN/CSA C22.2 No.14	■	■	■	■	■	■	■	■	■	■	■	■	■
	UL 1604 (Class I, Div 2, hazardous locations), CAN/CSA C22.2 No.213	▲		■		▲	■	▲	■		▲		■	■
	CB scheme				■					■				
	CCC				■					■				
Marks														
	CE	■	■	■	■	■	■	■	■	■	■	■	■	■
	C-Tick	■	■	■	■	■	■	■	■	■	■	■	■	■

Analog signal converters

Overview

Applications for analog signal processing and correct solution using CC-E and CC-U converters

Nearly every process includes a control system that receives data by means of analog signals and then evaluates the data and sets the respective parameters correspondingly. When transmitting analog signals numerous problems may arise which can disturb or even block an ideal behavior of the process.

Below we have listed some processing problems together with the respective solutions to solve these problems:

Signal conversion

Sometimes the available signals cannot be processed by the controller or the actuator. In this case, signal converters are required to convert the input signal (or different input signals) to the desired output signal.

Signal amplification

If long lines or high burdens have to be operated, it may be necessary to amplify the signal. CC analog signal converters require only low input power and provide high output power. Thus, there are no restrictions for the converter's position on the line, i.e. it can be used

- for signal refreshing (1) at the end of the line (low input power)
- or for signal amplification (2) at the beginning of the line (high output power).

Signal filtering

Particularly on long lines or in rough industrial environments the signals are exposed to high electromagnetic interferences. The frequency of the coupled interference signals may be in the range of the common mains frequency (50 Hz) or even much higher (in case of frequency converters). According to the specific requirements, analog signal converters are available which provide reliable suppression of those interferences by means of an input low-pass filter.

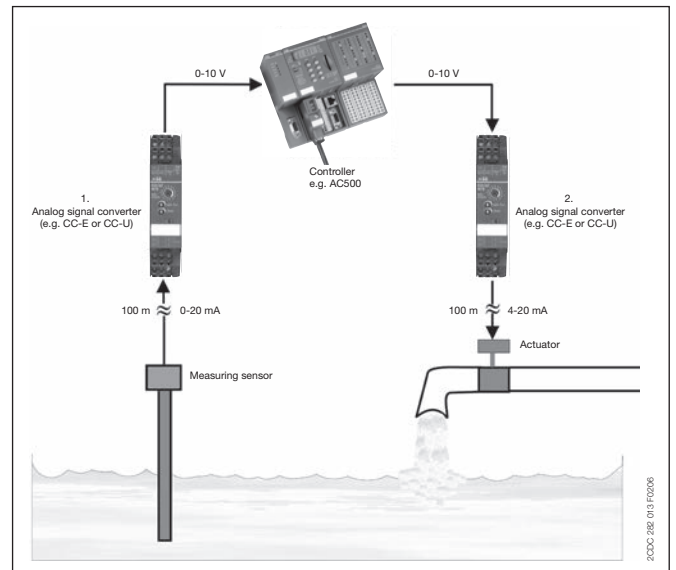

Signal separation

- Protection against overvoltage
The increased use of micro-electronics make controls much more sensitive against overvoltages, resulting from lightning discharges or switching processes. Suppression diodes are incorporated in the input of the CC analog signal converters which enable the converters to arrest overvoltages with low energy level (resulting from switching processes) by themselves. The products furthermore provide electrical isolation between input, output and supply circuit for protection of the controller connected to the output.
- Protection against ground loops
If components are used which refer to ground, the measuring signals can be falsified by a so-called ground loop. In this case, certain parts of the signal are transmitted via earth and not via the analog transmission line, thus causing incorrect evaluation of the signal. The electrical isolation between the input and the output disconnects these ground loops and thus enables correct signal transmission.

Analog signal converters - CC-E range

Benefits and advantages

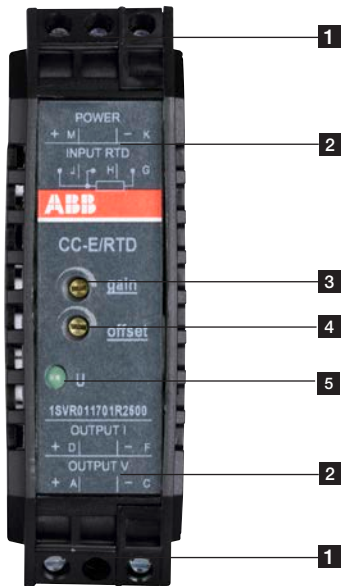

- 1** Terminals M, K, J, H, G
- 2** Terminal explanation
- 3** Adjustment of gain
- 4** Adjustment of offset
- 5** Indication of operational states
U - control supply voltage applied

4

CC-E range

- Universally configurable devices and single-function devices
- Adjustment and operating elements on the front side
- Safe operation by electrical 3-way isolation
- Unambiguous and clear connecting terminal markings

Conversion, measurement and separation of

- Standard signals (0-5 V, 0-10 V, 0-20 mA, 4-20 mA)
- Temperature signals of RTD sensors (PT 100)
- Thermocouple signals (types J and K)
- Current measurement signals (0-5 A, 0-20 A AC/DC)

Characteristics of single-function devices

- No adjustment or balancing necessary.

Characteristics of universal devices

- The required input and output ranges can be configured by means of directly accessible DIP switches positioned on the side
- Gain adjustment of $\pm 5\%$ by means of an adjustment potentiometer on the front-side
- Offset adjustment of $\pm 5\%$ by means of adjustment potentiometers on the front-side

CC-E/STD analog signal converter with 3-way electrical isolation

- 2 universally configurable devices (type CC-E/STD)
- 2x10 single-function devices
- "Plug and Work", no adjustment of single-function devices required

CC-E/TC analog signal converter for thermocouple signals of the types J and K with 3-way electrical isolation

- 2 universally configurable devices (type CC-E/TC)
- 2x6 single-function devices
- "Plug and Work", no adjustment of single-function devices required
- Integrated cold-junction compensation

CC-E I_{AC}/ILPO measuring converter without auxiliary power for sinusoidal currents 0-1 A, 0-5 A, output 4-20 mA

- Measuring converter for sinusoidal currents (0-1 A, 0-5 A)
- Measuring range selection by front-face sliding switch
- 4-20 mA output current in proportion to input current
- no additional power supply required

CC-E/RTD temperature signal converter for RTD sensors, linearized with 3-way electrical isolation

- 2 universally configurable devices (type CC-E/RTD)
- 2x12 single-function devices
- "Plug and Work", no adjustment of single-function devices required
- Temperature signal converter for PT100 sensors
- 2- or 3-wire connection

CC-E/I measuring converter for current signals 0-5 A, 0-20 A, AC/DC with 3-way electrical isolation

- 2 universally configurable devices (type CC-E/I)
- 2x6 single-function devices
- "Plug and Work", no adjustment of single-function devices required

Loop-powered current/current isolator without external power supply for analog current signals of 0-20 mA and 4-20 mA

- Electrical isolation between input and output
- Very low internal voltage drop $\leq 2.5\text{ V}$
- Available with one or two independent channels
- Width only 18 mm (1 and 2 channels)

Analog signal converters - CC-E range

Ordering details - Standard signal converters



CC-E/I

2CDC 281 010 F0003



CC-E V/V

2CDC 281 001 F0003



CC-E I/I-2

2CDC 281 041 F0003

Ordering details - Standard signal converters

Supply voltage range	Input signal	Output signal	Type	Order code	Price 1 pce	Weight (1 pce) kg (lb)	
24 V DC	0-5 V, 0-10 V, 0-20 mA, 4-20 mA	0-5 V, 0-10 V, 0-20 mA, 4-20 mA	CC-E/STD ¹⁾	1SVR011700R0000		0.088 (0.194)	
		0-10 V	CC-E V/V	1SVR011710R2100		0.083 (0.183)	
	0-10 V	0-20 mA	CC-E V/I	1SVR011711R1600		0.084 (0.185)	
		4-20 mA	CC-E V/I	1SVR011712R1700		0.084 (0.187)	
	0-20 mA	0-10 V	CC-E I/V	1SVR011713R1000		0.082 (0.181)	
		0-20 mA	CC-E I/I	1SVR011714R1100		0.084 (0.187)	
		4-20 mA	CC-E I/I	1SVR011715R1200		0.084 (0.185)	
		0-10 V	CC-E I/V	1SVR011716R1300		0.084 (0.185)	
	4-20 mA	0-20 mA	CC-E I/I	1SVR011717R1400		0.084 (0.187)	
		4-20 mA	CC-E I/I	1SVR011718R2500		0.082 (0.181)	
	-10...+10 V	-10...+10 V	CC-E V/V	1SVR011719R2600		0.082 (0.181)	
	110-240 V AC	0-5 V, 0-10 V, 0-20 mA, 4-20 mA	0-5 V, 0-10 V, 0-20 mA, 4-20 mA	CC-E/STD	1SVR011705R2100		0.090 (0.198)
0-10 V			CC-E V/V	1SVR011720R2300		0.096 (0.212)	
0-10 V		0-20 mA	CC-E V/I	1SVR011721R1000		0.087 (0.192)	
		4-20 mA	CC-E V/I	1SVR011722R1100		0.091 (0.200)	
0-10 V		0-10 V	CC-E I/V	1SVR011723R1200		0.091 (0.200)	
		0-20 mA	CC-E I/I	1SVR011724R1300		0.088 (0.194)	
4-20 mA		4-20 mA	CC-E I/I	1SVR011725R1400		0.088 (0.194)	
		0-10 V	CC-E I/V	1SVR011726R1500		0.096 (0.212)	
		0-20 mA	CC-E I/I	1SVR011727R1600		0.087 (0.192)	
		4-20 mA	CC-E I/I	1SVR011728R2700		0.088 (0.194)	
loop powered		-10...+10 V	-10...+10 V	CC-E V/V	1SVR011729R2000		0.086 (0.190)
		0-20 mA, 4-20 mA	0-20 mA, 4-20 mA	CC-E I/I-1 ²⁾	1SVR010200R1600		0.038 (0.084)
	CC-E I/I-2 ²⁾			1SVR010201R0300		0.044 (0.097)	

¹⁾ Ⓜ 1604 Class I, Div.2 (universal device)

²⁾ CC-E-I/I-1 has 1 channel, CC-E-I/I-2 has 2 channels



Further documentation analog signal converters CC-E on www.abb.com

Analog signal converters - CC-E range

Ordering details - RTD converters



CC-E/RTD

2CDC 281 004 F0003

4

Ordering details - RTD converters

Supply voltage range	Input signal	Output signal	Type	Order code	Price 1 pce	Weight (1 pce) kg (lb)	
24 V DC	refer to table ¹⁾	0-10 V, 0-20 mA, 4-20 mA	CC-E/RTD ²⁾	1SVR011701R2500		0.091 (0.200)	
	PT100 0...100 °C	0-10 V	CC-E RTD/V	1SVR011730R2500		0.084 (0.185)	
		0-20 mA	CC-E RTD/I	1SVR011731R1200		0.086 (0.190)	
		4-20 mA	CC-E RTD/I	1SVR011732R1300			
	PT100 -50...+50 °C	0-10 V	CC-E RTD/V	1SVR011733R1400		0.083 (0.183)	
		0-20 mA	CC-E RTD/I	1SVR011734R1500		0.084 (0.185)	
		4-20 mA	CC-E RTD/I	1SVR011735R1600		0.084 (0.187)	
	PT100 0...300 °C	0-10 V	CC-E RTD/V	1SVR011736R1700		0.084 (0.185)	
		0-20 mA	CC-E RTD/I	1SVR011737R1000		0.084 (0.187)	
		4-20 mA	CC-E RTD/I	1SVR011738R2100		0.101	
	PT100 -50...+250 °C	0-10 V	CC-E RTD/V	1SVR011739R2200		0.084 (0.185)	
		0-20 mA	CC-E RTD/I	1SVR011740R0700		0.084 (0.187)	
	110-240 V AC	refer to table ¹⁾	0-10 V, 0-20 mA, 4-20 mA	CC-E/RTD	1SVR011706R2200		0.093 (0.205)
		PT100 0...100 °C	0-10 V	CC-E RTD/V	1SVR011788R2400		0.086 (0.190)
0-20 mA			CC-E RTD/I	1SVR011789R2500		0.088 (0.194)	
4-20 mA			CC-E RTD/I	1SVR011790R2200		0.089 (0.196)	
PT100 -50...+50 °C		0-10 V	CC-E RTD/V	1SVR011791R1700		0.087 (0.192)	
		0-20 mA	CC-E RTD/I	1SVR011792R1000		0.089 (0.196)	
4-20 mA		CC-E RTD/I	1SVR011793R1100				
		0-10 V	CC-E RTD/V	1SVR011794R1200		0.087 (0.192)	
PT100 0...300 °C		0-20 mA	CC-E RTD/I	1SVR011795R1300		0.089 (0.196)	
		4-20 mA	CC-E RTD/I	1SVR011796R1400			
PT100 -50...+250 °C	0-10 V	CC-E RTD/V	1SVR011797R1500		0.086 (0.190)		
	0-20 mA	CC-E RTD/I	1SVR011798R2600		0.089 (0.196)		
4-20 mA	CC-E RTD/I	1SVR011799R2700		0.088 (0.194)			

¹⁾ Refer to "Technical data" on page 262.

²⁾ B 1604 Class I, Div.2 (universal device)



Further documentation ana-
log signal converters CC-E on
www.abb.com

Analog signal converters - CC-E range

Ordering details - Thermocouple converters



CC-E TC

2CDC 281 007 F0003

Ordering details - Thermocouple Converters

Supply voltage range	Input signal	Output signal	Type	Order code	Price 1 pce	Weight (1 pce) kg (lb)
24 V DC	thermocouple types J and K	0-10 V, 0-20 mA, 4-20 mA	CC-E/TC ¹⁾	1SVR011702R2600		0.089 (0.196)
	type J 0...600 °C	0-10 V	CC-E TC/V	1SVR011750R0100		0.087 (0.192)
		0-20 mA	CC-E TC/I	1SVR011751R2600		0.084 (0.187)
		4-20 mA	CC-E TC/I	1SVR011752R2700		0.102
		0-10 V	CC-E TC/V	1SVR011753R2000		0.084 (0.185)
	type K 0...1000 °C	0-20 mA	CC-E TC/I	1SVR011754R2100		0.086 (0.190)
		4-20 mA	CC-E TC/I	1SVR011755R2200		0.088 (0.194)
		thermocouple types J and K	0-10 V, 0-20 mA, 4-20 mA	CC-E/TC	1SVR011707R2300	
type J 0...600 °C			0-10 V	CC-E TC/V	1SVR011760R0300	
	0-20 mA		CC-E TC/I	1SVR011761R2000		0.1 (0.220)
	4-20 mA		CC-E TC/I	1SVR011762R2100		0.086 (0.190)
	type K 0...1000 °C	0-10 V	CC-E TC/V	1SVR011763R2200		0.088 (0.194)
0-20 mA		CC-E TC/I	1SVR011764R2300		0.086 (0.190)	
110-240 V AC	type K 0...1000 °C	0-20 mA	CC-E TC/I	1SVR011765R2400		0.088 (0.194)
		4-20 mA	CC-E TC/I	1SVR011765R2400		0.086 (0.190)

¹⁾ B 1604 Class I, Div.2 (universal device)



Further documentation analog signal converters CC-E on www.abb.com

Analog signal converters - CC-E range

Ordering details - Measuring converters



CC-E I_{AC}/ILPO

2CDC 281 018 F0004

4

Ordering details - Measuring Converters

Supply voltage range	Input signal	Output signal	Type	Order code	Price 1 pce	Weight (1 pce) kg (lb)
24 V DC	0-5 A, 0-20 A, AC/DC	0-10 V, 0-20 mA, 4-20 mA	CC-E/I ¹⁾	1SVR011703R2700		0.096 (0.212)
	0-5 A, 0-20 A, AC	0-10 V	CC-E I _{AC} /V	1SVR011770R0500		0.090 (0.198)
		0-20 mA	CC-E I _{AC} /I	1SVR011771R2200		0.092 (0.203)
		4-20 mA	CC-E I _{AC} /I	1SVR011772R2300		0.092 (0.207)
	0-5 A, 0-20 A, DC	0-10 V	CC-E I _{DC} /V	1SVR011773R2400		0.091 (0.200)
		0-20 mA	CC-E I _{DC} /I	1SVR011774R2500		0.093 (0.205)
110-240 V AC	0-5 A, 0-20 A, AC/DC	0-10 V, 0-20 mA, 4-20 mA	CC-E/I	1SVR011708R0400		0.099 (0.218)
	0-5 A, 0-20 A, AC	0-10 V	CC-E I _{AC} /V	1SVR011780R1100		0.092 (0.203)
		0-20 mA	CC-E I _{AC} /I	1SVR011781R0600		0.095 (0.209)
		4-20 mA	CC-E I _{AC} /I	1SVR011782R0700		0.093 (0.205)
	0-5 A, 0-20 A, DC	0-10 V	CC-E I _{DC} /V	1SVR011783R0000		0.095 (0.209)
		0-20 mA	CC-E I _{DC} /I	1SVR011784R0100		0.052 (0.115)
loop powered	0-1 A, 0-5 A, AC	4-20 mA	CC-E I _{AC} /ILPO ²⁾	1SVR010203R0500		0.095 (0.209)

¹⁾ 1604 Class I, Div.2 (universal device)

²⁾ for sinusoidal currents



Further documentation analog signal converters CC-E on www.abb.com

Analog signal converters - CC-E range

DIP switch settings, Dimensional drawings

CC-E/STD, CC-E x/x (universal devices)

Input	Output	Switch							
		1	2	3	4	5	6	7	8
0...5 V	0...5 V			■	■	■	■	■	■
	0...10 V			■	■	■	■	■	■
	0...20 mA			■	■	■	■	■	■
	4...20 mA			■	■	■	■	■	■
0...10 V	0...5 V			■	■	■	■	■	■
	0...10 V			■	■	■	■	■	■
	0...20 mA			■	■	■	■	■	■
	4...20 mA			■	■	■	■	■	■
0...20 mA	0...5 V	■							
	0...10 V	■							
	0...20 mA	■							
	4...20 mA	■							
4...20 mA	0...5 V	■	■						
	0...10 V	■	■						
	0...20 mA	■	■						
	4...20 mA	■	■						

2CDC 282 001 F0204

Legend	
■	ON
□	OFF

2CDC 282 002 F0204

CC-E/RTD

Input	Output	Switch					
		1	2	3	4	5	6
0...100 °C	0...10 V				■	■	■
	0-20 mA				■	■	■
	4-20 mA				■	■	■
0...300 °C	0-10 V				■	■	■
	0-20 mA				■	■	■
	4-20 mA				■	■	■
0...500 °C	0-10 V				■	■	■
	0-20 mA				■	■	■
	4-20 mA				■	■	■
-50...+50 °C	0-10 V	■					
	0-20 mA	■					
	4-20 mA	■					
-50...+250 °C	0-10 V	■	■				
	0-20 mA	■	■				
	4-20 mA	■	■				
-50...+450 °C	0-10 V	■	■				
	0-20 mA	■	■				
	4-20 mA	■	■				
High fail safe		■	■	■	■	■	■
Low fail safe		■	■	■	■	■	■

2CDC 282 006 F0208

Legend	
■	ON
□	OFF
□	no influence

2CDC 282 003 F0204

CC-E/TC

Input	Output	Switch					
		1	2	3	4	5	6
TC-J: 0...600 °C	0...10 V		■	■			■
	0...20 mA		■	■			■
	4...20 mA		■	■			■
TC-K: 0...1000 °C	0...10 V	■					■
	0...20 mA	■					■
	4...20 mA	■					■
High fail safe		■	■	■	■	■	■
Low fail safe		■	■	■	■	■	■

2CDC 282 007 F0208

Legend	
■	ON
□	OFF
□	no influence

2CDC 282 003 F0204

CC-E/I

Input	Output	Switch					
		1	2	3	4	5	6
I - DC	0...10 V	■					
		■					
I - AC	0...20 mA	■					
		■					
I - DC	4...20 mA	■	■				
		■	■				
I - AC	4...20 mA	■	■				
		■	■				

2CDC 282 005 F0208

Legend	
■	ON
□	OFF

2CDC 282 002 F0204

Input range selection - CC-E/I

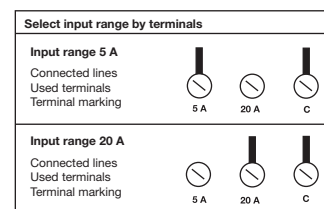

2CDC 282 011 F0204

Dimensional drawings

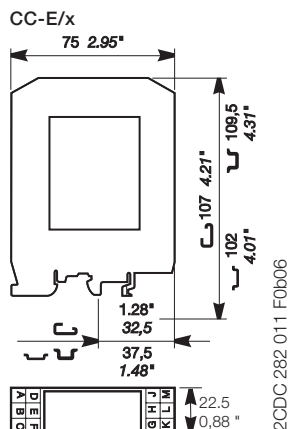

CC-E I_{AC}/ILPO, CC-E I/I

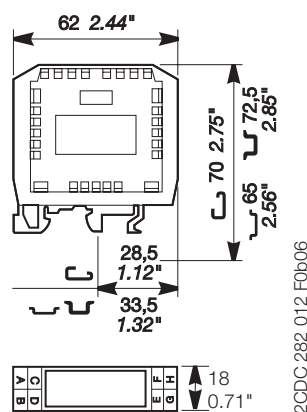

Analogue signal converters - CC-E range

Wiring instructions

CC-E/STD, CC-E x/x (universal devices)

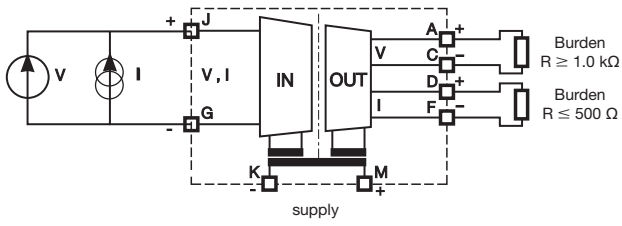

2CDC 282 006 F0206

CC-E/RTD

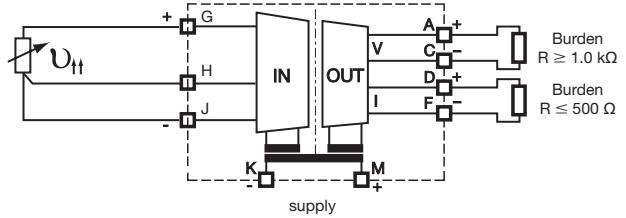

2CDC 282 007 F0206

4

CC-E/TC

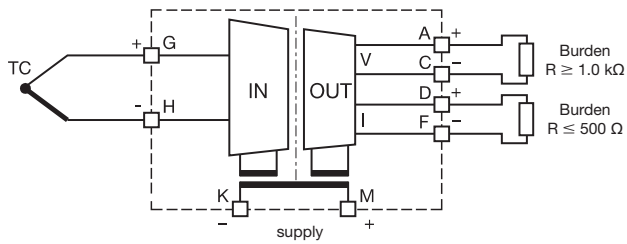

2CDC 282 008 F0206

CC-E I_{AC}/ILPO

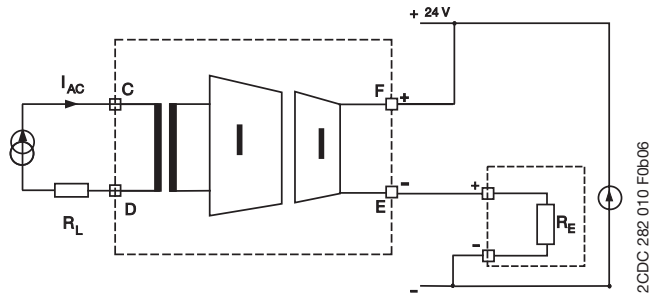

2CDC 282 010 F0b06

CC-E I/I-1

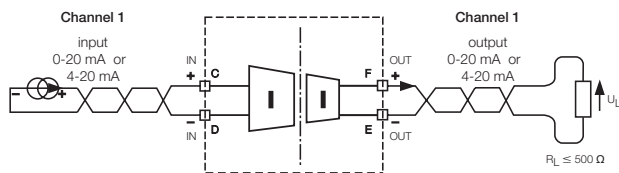

2CDC 282 003 F0205

CC-E I/I-2

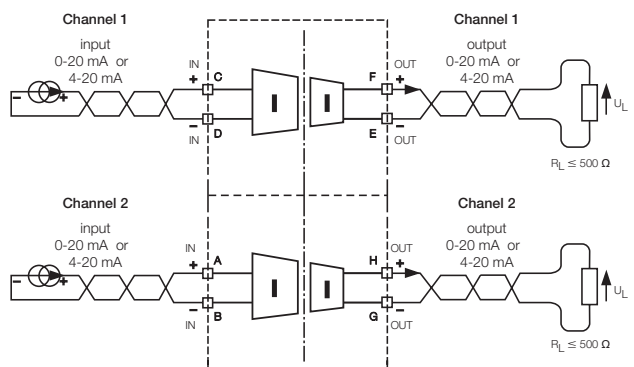

2CDC 282 004 F0205

CC-E I/I

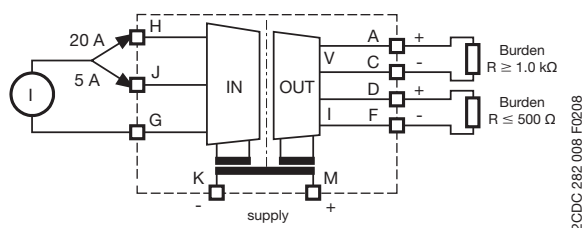

2CDC 282 008 F0208

Analog signal converters - CC-E range

Technical data

Type	CC-E/STD / CC-E x/x	CC-E/RTD ³⁾	CC-E/TC
Input circuits - Analog inputs	J-G-H	Current	Voltage
Input signal	Standard signals		PT100
Rated input range	0...20 mA / 4...20 mA	0...5 V / 0...10 V / -10...+10 V	-50...+500 °C
Limitation of input signals	+55 mA ± 11 V		
Influence of line resistance	-		< 0.01 %/Ω
Gain adjustment range	± 5 % (universal devices)		< 0.5 % / 100 Ω
Offset adjustment range	± 5 % (universal devices)		
Input impedance	50 Ω	1 MΩ	-
Suppression at 50 Hz	-		> 35 dB
Common-mode rejection	-		100 dB
Output circuits - Analog outputs	D-F, A-C	Current	Voltage
Output signal	0-20 mA, 4-20 mA		0-5 V, 0-10 V
Output burden	≤ 500 Ω		≥ 1.0 kΩ
Accuracy ¹⁾	± 0.5 % of full-scale		
Residual ripple	< 0.5 %		
Response time	200 μs	10 ms	
Transmission frequency	2 kHz	80 Hz	2 Hz (up to -3 dB)
Reaction to input circuit interruption			High fail safe: Output voltage > 115 % of measuring range ²⁾ Low fail safe: Output voltage < -0.6 V, output current = 0 mA
Supply circuits	K-M	DC versions	AC versions
Supply voltage	24 V DC		110-240 V AC - 50/60 Hz
Supply voltage tolerance	-15...+15 %		-15...+10 %
Power consumption	1.5 W typ.		1.5 VA typ.
Indication of operational states	Rated control supply voltage U _s		
	U: green LED		
General data	Ambient temperature range operation / storage		
	0...+60 °C / -20...+80 °C		
	Temperature coefficient		
	± 500 ppm/°C		
	Degree of protection (DIN 40050)		
	IP20		
	Mounting position		
	ventilation slots on top and bottom		
	Mounting		
	DIN rail (IEC/EN 60715), snap-on mounting		
Electrical connection	Wire size		
	rigid	0.2-4 mm ² (24-12 AWG)	
	fine-strand with(out) wire end ferrule	0.2-2.5 mm ² (24-14 AWG)	
	Stripping length	7 mm (0.28 inch)	
	Tightening torque	0.5 Nm (4.4 lb.in)	
Electromagnetic compatibility	Interference immunity		
	electrostatic discharge (ESD)	IEC/EN 61000-4-2	EN 61000-6-2 Level 3 (±6 kV / ±8 kV)
	electromagnetic field (HF radiation resistance)	IEC/EN 61000-4-3	10 V/m
	fast transients (Burst)	IEC/EN 61000-4-4	Level 3 (±2 kV / 5 kHz)
	powerful impulses (Surge)	IEC/EN 61000-4-5	±2 kV / ±1 kV
	HF line emission	IEC/EN 61000-4-6	10 V
	Interference emission	EN 61000-6-4	Class B
Isolation data	Test voltage between all isolated circuits		
	2.5 kV AC		
	Rated insulation voltage		
	-		

¹⁾ Includes non-linearity and factory setting, influenced by supply voltage and output load.

²⁾ Only -/RTD and -/TC: Single-function devices respond with Low fail safe to input signal interruptions.

³⁾ When connecting a 2-wire sensor, the terminals J and H have to be jumpered.

Approvals see "Overview" on page 253

Analog signal converters - CC-E range

Technical data

Type	CC-E I/I-1 / CC-E I/I-2	
Input circuits - Analog inputs		
Current		
Input current I_{IN}	0-20 mA, 4-20 mA	
Min. input current	< 100 μ A	
Max. input current	50 mA ¹⁾ ($V_{IN} < 18$ V)	
Input voltage U_{IN}	< 2.5 V + ($I_{IN} \times R_i$)	
Input voltage drop U_i	< 2.5 V (20 mA, $R_L = 0 \Omega$)	
Max. input voltage	18 V ¹⁾ ($I_{IN} < 50$ mA)	
Output circuits		
Output current I_{OUT}	0-20 mA, 4-20 mA	
Output load R_L	0-500 Ω	
Output voltage U_{OUT}	$I_{OUT} \times R_L$	
Residual ripple	< 20 mV _{RP} (500 Ω , 20 mA)	
Response time (0-100 %)	< 15 ms (0-500 Ω , 20 mA), < 5 ms (500 Ω , 20 mA, 25 °C)	
Accuracy	≤ 0.1 % of full-scale (20 mA)	
Load influence (0-500 Ω)	$\leq \pm 0.05$ % / 100 Ω , ≤ -0.1 % / 100 Ω (25 °C)	
General data		
Width of the enclosure	18 mm	
Weight	1 channel	approx. 0.037 kg (0.082 (0.181) lb)
	2 channel	approx. 0.044 (0.097) kg (0.097 lb)
Mounting position	any	
Degree of protection	enclosure / terminals IP20 / IP20	
Ambient temperature range	operation / storage -25...+60 °C / -40...+85 °C	
Temperature coefficient	< ± 50 ppm / °C	
Mounting	DIN rail (IEC/EN 60715)	
Electrical connection		
Wire size	rigid	0.2-4 mm ² (24-12 AWG)
	fine-strand with(out) wire end ferrule	0.2-2.5 mm ² (24-14 AWG)
Stripping length	7 mm (0.28 inch)	
Tightening torque	0.5 Nm (4.4 lb.in)	
Standards		
Product standard	EN 50178	
Low Voltage Directive	2006/95/EC	
EMC Directive	2004/108/EC	
Electromagnetic compatibility		
Interference immunity	EN 61000-6-2	
electrostatic discharge (ESD)	EN 61000-4-2	Level 3 (± 6 kV / ± 8 kV)
electromagnetic field (HF radiation resistance)	EN 61000-4-3	10 V/m
fast transients (Burst)	EN 61000-4-4	Level 3 (± 2 kV / 5 kHz)
powerful impulses (Surge)	EN 61000-4-5	± 2 kV / ± 1 kV
HF line emission	EN 61000-4-6	10 V
magnetic fields	EN 61000-4-8	30 A/m
Interference emission	EN 61000-6-4	
Radiated noise	EN 55011	Class B
Operational reliability (EN 68-2-6)	4 g	
Mechanical resistance (EN 68-2-6)	10 g	
Environmental testing (IEC 68-2-30 Db)	24 h cycle, 55 °C, 93 % rel., 96 h	
Isolation data		
Insulation voltage input / output	500 V _{eff} / 50 Hz	
Insulation voltage between channels	5 kV _{eff} / 50 Hz (device with 2 channels)	
Pollution category	2	
Overvoltage category	II	

¹⁾ The input parameters have to be limited to the indicated maximum values.
Approvals see "Overview" on page 253

Analog signal converters - CC-E range

Technical data

Type	CC-E/I J-G-H		CC-E I _{Ac} /ILPO C-D
	AC current	DC current	2 meas. ranges selectable
Input circuits - Analog inputs			
Rated input range	0-5 A / 0-20 A	0-5 A / 0-20 A	0-1 A / 0-5 A / sinusoidal
Measuring frequency			50/60 Hz
Overload capacity of inputs	input range 1 10 x I _{Nom} (50 A) for max. 1 s		10 x I _{Nom} (50 A) for max. 2 s
	input range 2 10 x I _{Nom} (200 A) for max. 1 s		10 x I _{Nom} (200 A) for max. 2 s
Gain adjustment range	±5 % (universal devices)		-
Offset adjustment range	±5 % (universal devices)		-
Input impedance / resistance	5A : 65 mΩ	20 A : 2.5 mΩ	5 mΩ
Output circuits - Analog outputs	D-F Current	A-C Voltage	F-E passive current output in proportion to input current
Output signal	0-20 mA / 4-20 mA	0-10 V	4-20 mA
Output burden / load	≤ 500 Ω	≥ 1.0 Ω	12 V DC: 150 Ω 24 V DC: 750 Ω 30 V DC: 1050 Ω
Accuracy ¹⁾	± 2 % of full-scale		
Offset adjustment range	±5 % (universal device)		± 5 %
Gain adjustment range	±5 % (universal device)		± 20 %
Residual ripple	< 0.5 %		
Response time	0.5 s		0.6 s
Transmission frequency	DC or 50/60 Hz		AC: 50/60 Hz
Reaction to input circuit interruption	Low fail safe: output voltage < 200 mV, output current < 400 μA		-
Supply circuits	K-M	DC versions	AC versions
Supply voltage		24 V DC	110-240 V AC 50/60 Hz
Supply voltage tolerance		-15...+15 %	12-30 V DC
Power consumption		typ 1.5 W	typ 1.5 VA
Indication of operational states			
Supply voltage		U: green LED	-
General data			
Ambient temperature range operation / storage	0...+60 °C / -20...+80 °C		-20...+60 °C / -40...+80 °C
Temperature coefficient	± 500 ppm/°C		300 ppm/°C
Degree of protection (DIN 40050)	IP20		
Mounting position	ventilation slots on top and bottom		
Mounting	DIN rail (IEC/EN 60715), snap-on mounting		
Electrical connection			
Wire size	rigid	0.2-4 mm ² (24-12 AWG)	
	fine-strand with(out) wire end ferrule	0.2-2.5 mm ² (24-14 AWG)	
Stripping length		7 mm (0.28 inch)	
Tightening torque		0.5 Nm (4.4 lb.in)	
Electromagnetic compatibility			
Interference immunity		EN 61000-6-2	
electrostatic discharge (ESD)	IEC/EN 61000-4-2	Level 3 (±6 kV / ±8 kV)	
electromagnetic field (HF radiation resistance)	IEC/EN 61000-4-3	10 V/m	
fast transients (Burst)	IEC/EN 61000-4-4	Level 3 (±2 kV / 5 kHz)	
powerful impulses (Surge)	IEC/EN 61000-4-5	±2 kV / ±1 kV	
HF line emission	IEC/EN 61000-4-6	10 V	
Interference emission	EN 61000-6-4	Class B	
Isolation data			
Test voltage (between all isolated circuits)	2.5 kV AC		
Rated insulation voltage	-		250 V AC

¹⁾ Includes non-linearity and factory setting, influenced by supply voltage and output load.
Approvals see "Overview" on page 253

Analog signal converters - CC-U range

Overview

CC-U range

- 8 different standard signal outputs on one device
- Input and output side universally configurable
- Also available with 2 threshold relay outputs
- Adjustment and operating elements on the front side
- Safe operation by electrical 3-way isolation
- Plug-in connecting terminals, unambiguously and clearly marked

Conversion, measurement and separation of

- Standard signals
- Signals of RTD sensors (PT10, PT100, PT1000)
- Thermocouple signals
- TRMS values of currents and voltages

Characteristics

- The required input and output ranges can be configured for all devices by means of directly accessible DIP switches positioned on the side.
- Due to the wide input range of the gain and offset stages all input signals between the minimum and the maximum input value can be universally converted to all common output signals.
- Devices for DC or AC (50/60 Hz) supply available.

4

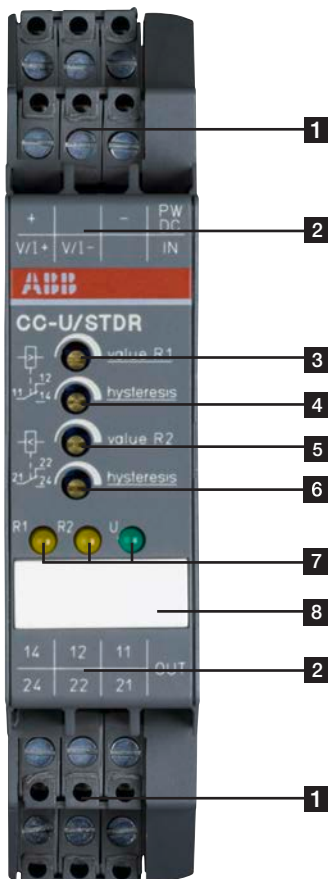

- 1 Terminals +, V/I+, V/I-, PW DC, IN, -
- 2 Terminal explanation
- 3 Adjustment of resistance value R1
- 4 Adjustment of hysteresis
- 5 Adjustment of resistance value R2
- 6 Adjustment of hysteresis
- 7 Indication of operational states
R1 yellow LED - resistance value R1
R2 yellow LED - resistance value R2
U green LED - supply voltage
- 8 Marker label

Analog signal converters - CC-U range

Overview

CC-U/STD universal signal converter with 3-way electrical isolation

- More than 120 configurations possible
- Configurable output signal response on input voltage signal interruption (low fail safe / high fail safe)
- Adjustment and operating elements on the front
- Short-circuit proof signal outputs
- Plug-in connecting terminals for inputs, outputs and supply
- Very fast signal transmission enables use in control systems

CC-U/RTD universal signal converter for PT10, PT100, PT1000 temperature sensors (acc. to IEC 751 and JIS C 16041), linearized with 3-way electrical isolation

- Configurable output signal response on input signal interruption (low / high fail safe)
- Adjustment and operating elements on the front-side
- Short-circuit proof signal outputs
- Plug-in connecting terminals for inputs, outputs and supply
- 2- or 3-wire connection

¹⁾ Japanese standard

CC-U/TC universal signal converter for thermocouples with 3-way electrical isolation

- Temperature signal converter for thermocouples of the types K, J, T, S, E, N, R, B
- Continuously adjustable voltage signal input 0-10 mV and 0-50 mV
- Differential temperature meas. possible (see "Wiring instructions" on page 271)
- Configurable output signal response on input signal interruption (low fail safe / high fail safe)
- Adjustment and operating elements on the front-side
- Short-circuit proof signal outputs
- Plug-in connecting terminals for inputs, outputs and supply
- Cold-junction compensation selectable

CC-U/V universal measuring converter for RMS values of 0-600 V, with 3-way electrical isolation

- RMS converter for voltage signals up to 600 V of any wave form (DC, DC with superimposed AC components, pure sinusoidal, triangular, phase-angle controlled, etc. in a measuring range of 0-600 Hz)
- Adjustment and operating elements on the front
- Short-circuit proof signal outputs
- Plug-in connecting terminals for inputs, outputs and supply

CC-U/STDR universal signal converter for standard signals, with 2 threshold relay outputs and with 3-way electrical isolation

- Standard signal converter with 7 setting ranges
- 2 threshold relay outputs with one c/o contact each (threshold and respective hysteresis can be adjusted independently from each other)
- Open-circuit or closed-circuit principle configurable by means of a DIP switch
- 2 yellow LEDs for clear status indication of the output relays
- Plug-in connecting terminals for inputs, outputs and supply

CC-U/TCR universal signal converter for thermocouples, with 2 threshold relay outputs and 3-way electrical isolation

- Temperature signal converter for thermocouples of the types K, J, T, S
- 2 threshold relay outputs with one change-over contact each (threshold and respective hysteresis can be adjusted independently from each other)
- Open-circuit or closed-circuit principle configurable by means of a DIP switch
- 2 yellow LEDs for clear status indication of the output relays
- Plug-in connecting terminals for inputs, outputs and supply
- Integrated cold-junction compensation

CC-U/I universal measuring converter for RMS values of 0-1 A and 0-5 A, with 3-way electrical isolation

- RMS converter for current signals up to 1 A and up to 5 A of any wave form (DC, DC with superimposed AC components, pure sinusoidal, triangular, phase-angle controlled, etc. in a measuring range of 0-600 Hz)
- Adjustment and operating elements on the front
- Short-circuit proof signal outputs
- Plug-in connecting terminals for inputs, outputs and supply

Analog signal converters - CC-U range

Ordering details



2CDC 281 003 F0003

4 CC-U/STDR

Ordering details - Standard Signal Converters

Supply voltage range	Input signal	Output signal	Type	Order code	Price 1 pce	Weight (1 pce) kg (lb)
24-48 V DC, 24 V AC	refer to table	refer to table	CC-U/STD	1SVR040000R1700		0.125 (0.276)
110-240 V AC, 100-300 V DC				1SVR040001R0400		0.126 (0.278)
24-48 V DC, 24 V AC		2 c/o	CC-U/ STDR ¹⁾	1SVR040010R0000		0.142 (0.313)
110-240 V AC, 100-300 V DC				1SVR040011R2500		



2CDC 281 005 F0003

CC-U/RTD

Ordering details - RTD Converters

Supply voltage range	Input signal	Output signal	Type	Order code	Price 1 pce	Weight (1 pce) kg (lb)
24-48 V DC, 24 V AC	refer to table	refer to table	CC-U/RTD	1SVR040002R0500		0.126 (0.278)
110-240 V AC, 100-300 V DC				1SVR040003R0600		0.128 (0.282)



2CDC 281 008 F0003

CC-U/TC

Ordering details - Thermocouple Converters

Supply voltage range	Input signal	Output signal	Type	Order code	Price 1 pce	Weight (1 pce) kg (lb)
24-48 V DC, 24 V AC	refer to table	refer to table	CC-U/TC	1SVR040004R0700		0.130 (0.287)
110-240 V AC, 100-300 V DC				1SVR040005R0000		0.128 (0.282)
24-48 V DC, 24 V AC		2 c/o	CC-U/TCR ¹⁾	1SVR040014R2000		0.145 (0.320)
110-240 V AC, 100-300 V DC				1SVR040015R2100		



2CDC 281 012 F0003

CC-U/I

Ordering details - Measuring Converters

Supply voltage range	Input signal	Output signal	Type	Order code	Price 1 pce	Weight (1 pce) kg (lb)
24-48 V DC, 24 V AC	refer to table	refer to table	CC-U/I ²⁾	1SVR040006R0100		0.128 (0.282)
110-240 V AC, 100-300 V DC				1SVR040007R0200		0.127 (0.280)
24-48 V DC, 24 V AC			CC-U/V ³⁾	1SVR040008R1300		0.128 (0.282)
110-240 V AC, 100-300 V DC				1SVR040009R1400		

¹⁾ with relay output

²⁾ for current RMS values

³⁾ for voltage RMS values

Analog signal converters - CC-U range

Ordering details - Accessories

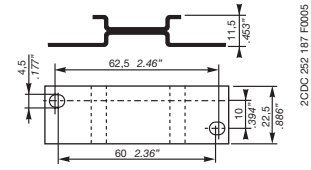

ADP.01

2CDC 252 187 F0005

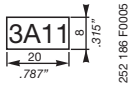

MAR.01

252 186 F0005

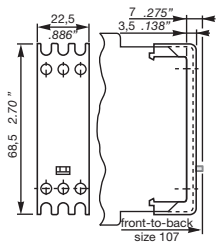

Sealable cover - COV.01

2CDC 252 185 F0005

Ordering details - Accessories

For type	Width in mm	Type	Order code	Price	Pkg qty	Weight (1 pce) g (oz)
CC-U	22.5	ADP.01	1SVR430029R0100		1	18.4 (0.65)
CC-U		MAR.01	1SVR366017R0100		10	0.19 (0.007)
CC-U	22.5	COV.01	1SVR430005R0100		1	5.2 (0.18)

Analog signal converters - CC-U range DIP switch settings

CC-U/STD

Input	Switch 1								Gain	Coarse Type
	1	2	3	4	5	6	7	8		
Potentiometer									0	0
0...50 mV									A...D	C
0...100 mV									4...5	5
0...250 mV									0...1	1
0...500 mV									7...9	8
0...1 V									3...4	3
0...2.5 V									0	0
0...5 V									5...7	6
0...10 V									7...9	8
1...5 V									2...4	3
2...10 V									0	0
-10...+10 V									3...4	3
0...125 mV									3...4	3
0...8 V									B...F	D
-22.5...+22.5 mV									0	0
-11...+11 V									5...7	6
2.5...7.5 V									3...4	4
3.33...9.99 V									2	2
10...0 V									4...5	5
100...0 mV									A...D	B
0...1 mA									2...4	3
0...20 mA									4...5	4
10...50 mA									0...1	1
20...4 mA									4...5	4
20...0 mA									4...2	3
-0.45...+0.45 mA									B...F	D
-55...+55 mA									4...6	5
High fail safe *)									-	-
Low fail safe *)									-	-
No fail safe *)									-	-

2CDC 282 019 F0203

*) Detection of input voltage signal interruptions:
If the input signal circuit is interrupted, the output signal changes to the adjusted minimum value (low fail safe) or maximum value (high fail safe).
If "No fail safe" is configured, input signal interruptions are not detected.

Output	Switch 2					
	1	2	3	4	5	6
0...5 V						
0...10 V						
1...5 V						
2...10 V						
-10...+10 V						
-5...+5 V						
-10...0 V						
-5...0 V						
0...6.66 V						
-10...+3.33 V						
-5...+1.66 V						
0...8 V						
0...4 V						
-10...-2 V						
-5...-1 V						
1.25...6.25 V						
-7.5...+2.5 V						
-3.75...+1.25 V						
1.66...8.33 V						
-6.66...+6.66 V						
-3.33...+3.33 V						
-8...0 V						
-4...0 V						
0...1 mA						
0...20 mA						
4...20 mA						
0...10 mA						
0...0.5 mA						
0...13.33 mA						
0...666 µA						
0...16 mA						
0...800 µA						
0...8 mA						
0...400 µA						
2.5...12.5 mA						
125...625 µA						
3.33...16.66 mA						
166...833 µA						
0.2...1 mA						
2...10 mA						
100...500 µA						

2CDC 282 020 F0203

Legend
ON
OFF
no influence

2CDC 282 003 F0204

CC-U/STDR with relay output

Input	Switch					
	1	2	3	4	5	6
0...10 V						
0...5 V						
0...1 V						
-10...+10 V						
1...5 V						
0...20 mA						
4...20 mA						
Output						
Closed-circuit principle						
Open-circuit principle						

2CDC 282 005 F0204

Legend
ON
OFF
no influence

2CDC 282 003 F0204

CC-U/RTD

Type	Input Range	Switch 1						Switch 2						Gain Coarse	
		1	2	3	4	5	6	1	2	3	4	5	6		
PT10	0...500 °C														F
	0...550 °C														E
	0...600 °C														D
	0...650 °C														C
	0...700 °C														B
	0...750 °C														A
	0...800 °C														9
PT100	0...850 °C														8
	0...50 °C														F
	0...60 °C														E
	0...70 °C														B
	0...80 °C														A
	0...90 °C														9
	0...100 °C														8
PT1000	0...200 °C														3
	0...300 °C														2
	0...400 °C														1
	0...500 °C														0
	0...10 °C														8
	0...20 °C														3
	0...30 °C														2
Low fail safe *)	0...40 °C														1
	0...50 °C														0
	0...60 °C														0
High fail safe *)														-	-

2CDC 282 023 F0203

Output	Switch 3					
	1	2	3	4	5	6
0...5 V						
0...10 V						
1...5 V						
2...10 V						
-10...+10 V						
-5...+5 V						
-10...0 V						
-5...0 V						
0...6.66 V						
-10...+3.33 V						
-5...+1.66 V						
0...8 V						
0...4 V						
-10...-2 V						
-5...-1 V						
1.25...6.25 V						
-7.5...+2.5 V						
-3.75...+1.25 V						
1.66...8.33 V						
-6.66...+6.66 V						
-3.33...+3.33 V						
-8...0 V						
-4...0 V						
0...1 mA						
0...20 mA						
4...20 mA						
0...10 mA						
0...0.5 mA						
0...13.33 mA						
0...666 µA						
0...16 mA						
0...800 µA						
0...8 mA						
0...400 µA						
2.5...12.5 mA						
125...625 µA						
3.33...16.66 mA						
166...833 µA						
0.2...1 mA						
2...10 mA						
100...500 µA						

2CDC 282 024 F0203

Legend
ON
OFF
no influence

2CDC 282 003 F0204

Analog signal converters - CC-U range

DIP switch settings

CC-U/V

Output	Switch					
	1	2	3	4	5	6
0...5 V						
0...10 V						
1...5 V						
2...10 V						
-10...+10 V						
-5...+5 V						
-10...0 V						
-5...0 V						
0...6.66 V						
-10...+3.33 V						
-5...+1.66 V						
0...8 V						
0...4 V						
-10...-2 V						
-5...-1 V						
1.25...6.25 V						
-7.5...+2.5 V						
-3.75...+1.25 V						
1.66...8.33 V						
-6.66...+6.66 V						
-3.33...+3.33 V						
-8...0 V						
-4...0 V						
0...1 mA						
0...20 mA						
4...20 mA						
0...10 mA						
0...0.5 mA						
0...13.33 mA						
0...666 µA						
0...16 mA						
0...800 µA						
0...8 mA						
0...400 µA						
2.5...12.5 mA						
125...625 µA						
3.33...16.66 mA						
166...833 µA						
0.2...1 mA						
2...10 mA						
100...500 µA						

Legend	
■	ON
□	OFF
■	no influence

2CDC 282 003 F0204 2CDC 282 029 F0203

CC-U/TC

Output	Switch 3					
	1	2	3	4	5	6
0...5 V						
0...10 V						
1...5 V						
2...10 V						
-10...+10 V						
-5...+5 V						
-10...0 V						
-5...0 V						
0...6.66 V						
-10...+3.33 V						
-5...+1.66 V						
0...8 V						
0...4 V						
-10...-2 V						
-5...-1 V						
1.25...6.25 V						
-7.5...+2.5 V						
-3.75...+1.25 V						
1.66...8.33 V						
-6.66...+6.66 V						
-3.33...+3.33 V						
-8...0 V						
-4...0 V						
0...1 mA						
0...20 mA						
4...20 mA						
0...10 mA						
0...0.5 mA						
0...13.33 mA						
0...666 µA						
0...16 mA						
0...800 µA						
0...8 mA						
0...400 µA						
2.5...12.5 mA						
125...625 µA						
3.33...16.66 mA						
166...833 µA						
0.2...1 mA						
2...10 mA						
100...500 µA						

Legend	
■	ON
□	OFF
■	no influence

2CDC 282 017 F0208

2CDC 282 003 F0204

Type	Input Range	Switch 1						Switch 2						
		1	2	3	4	5	6	1	2	3	4	5	6	
K	0-100...900 °C													
J	0-250...1350 °C													
T	0-100...750 °C													
T	0-100...400 °C													
T	-150-0...400 °C													
S	0-250...1550 °C													
E	0-100...700 °C													
E	0-200...1000 °C													
N	0-100...650 °C													
N	0-200...1300 °C													
R	0-250...1350 °C													
R	0-450...1700 °C													
B	0-700...1750 °C													
mV	0-2...10 mV													
mV	0-10...50 mV													
	Low fall safe *)													
	High fall safe *)													

2CDC 282 010 F0204

*) Detection of input signal interruptions:

If the input signal circuit is interrupted, the output signal changes to the adjusted minimum value (low fail safe) or maximum value (high fail safe).

CC-U/I

Output	Switch					
	1	2	3	4	5	6
0...5 V						
0...10 V						
1...5 V						
2...10 V						
-10...+10 V						
-5...+5 V						
-10...0 V						
-5...0 V						
0...6.66 V						
-10...+3.33 V						
-5...+1.66 V						
0...8 V						
0...4 V						
-10...-2 V						
-5...-1 V						
1.25...6.25 V						
-7.5...+2.5 V						
-3.75...+1.25 V						
1.66...8.33 V						
-6.66...+6.66 V						
-3.33...+3.33 V						
-8...0 V						
-4...0 V						
0...1 mA						
0...20 mA						
4...20 mA						
0...10 mA						
0...0.5 mA						
0...13.33 mA						
0...666 µA						
0...16 mA						
0...800 µA						
0...8 mA						
0...400 µA						
2.5...12.5 mA						
125...625 µA						
3.33...16.66 mA						
166...833 µA						
0.2...1 mA						
2...10 mA						
100...500 µA						

Legend	
■	ON
□	OFF
■	no influence

2CDC 282 003 F0204 2CDC 282 029 F0203

CC-U/TCR with relay output

Type	Input Range	Switch					
		1	2	3	4	5	6
J	0...240 °C						
J	0...480 °C						
K	0...1200 °C						
K	0...500 °C						
K	0...1350 °C						
T	-150...+120 °C						
T	0...220 °C						
T	0...400 °C						
S	0...210 °C						
S	0...380 °C						
S	0...860 °C						
S	0...1550 °C						
Output							
Closed-circuit principle							
Open-circuit principle							

Legend	
■	ON
□	OFF
■	no influence

2CDC 282 004 F0204

2CDC 282 003 F0204

Analog signal converters - CC-U range

Wiring instructions

CC-U/STD

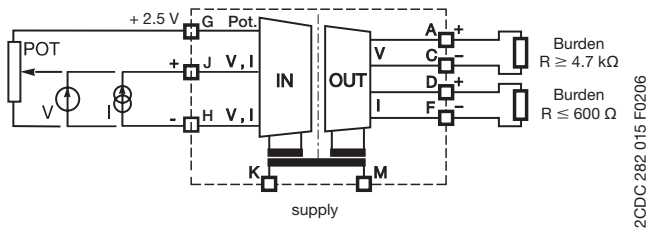

CC-U/STDR with relay output

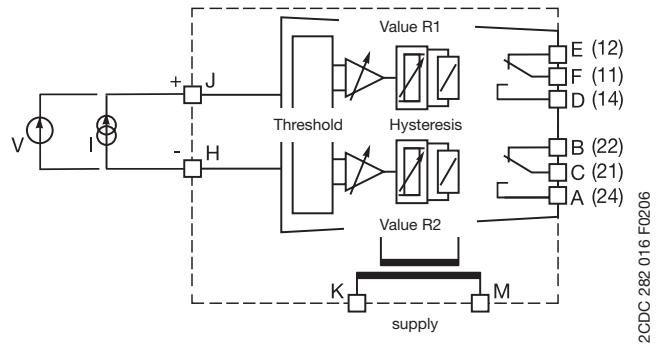

CC-U/RTD

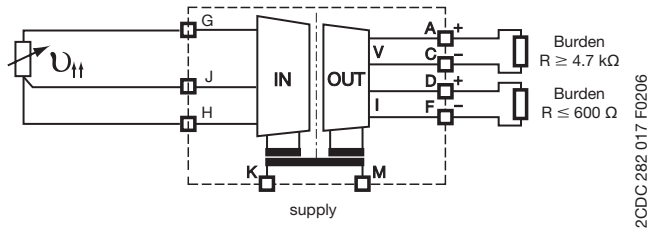

CC-U/V

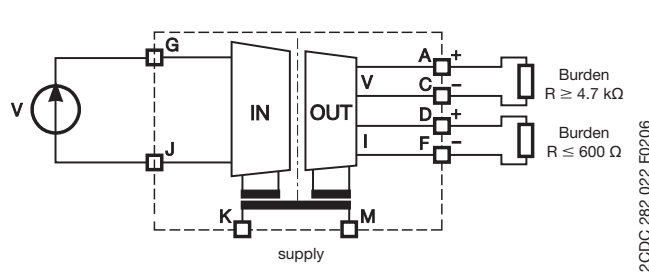

CC-U/I

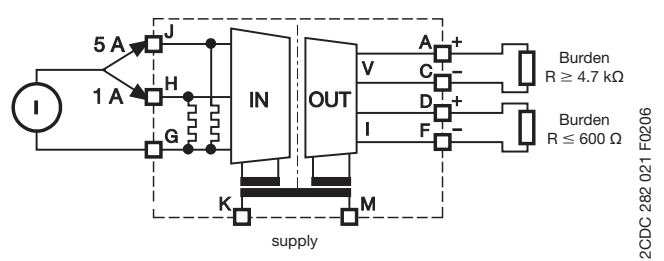

CC-U/TC

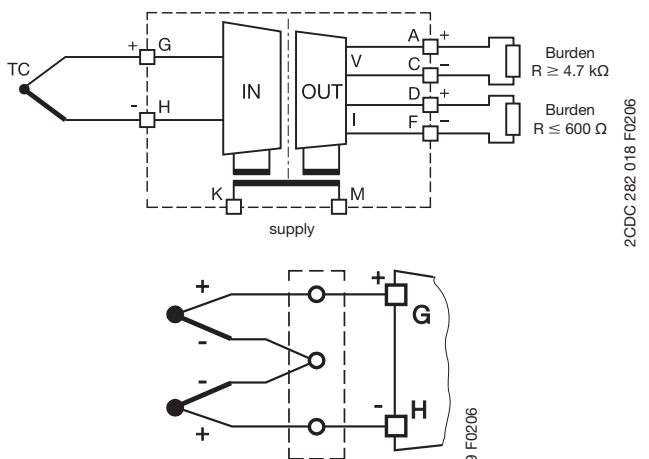

CC-U/TCR with relay output

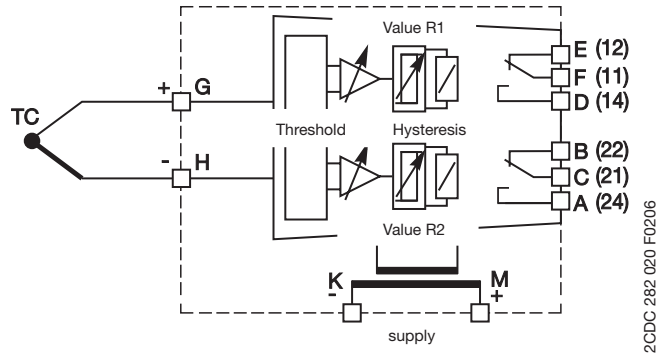

without cold-junction compensation:
 switch SW2.2 = OFF

2CDC 282 019 F0206

Analog signal converters - CC-U range

Technical information

CC-U/STD

Adjustment range

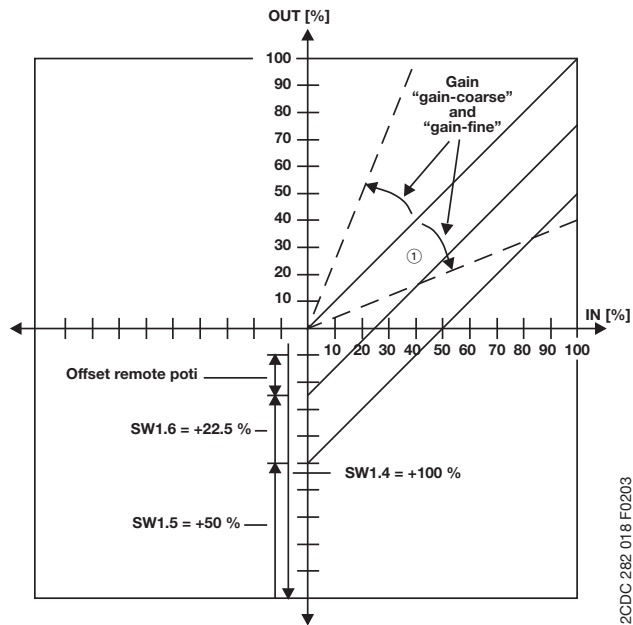

CC-U/STDR with relay output

Function diagrams

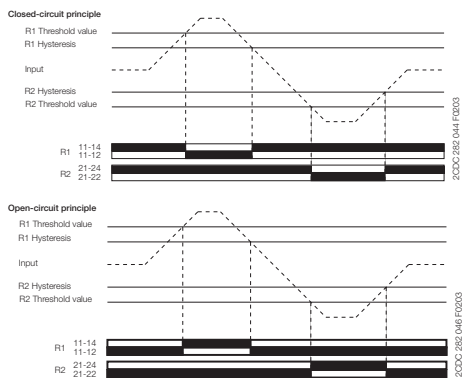

Switching points

Switching points of the output relay depending on the input range, configuration open-circuit principle

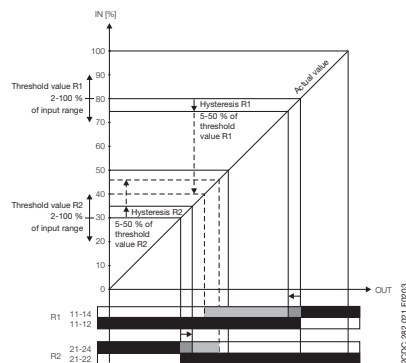

Analog signal converters - CC-U range

Technical information

CC-U/RTD

Characteristic curves

Resistance of PT10, PT100 and PT1000 sensors depending on the temperature

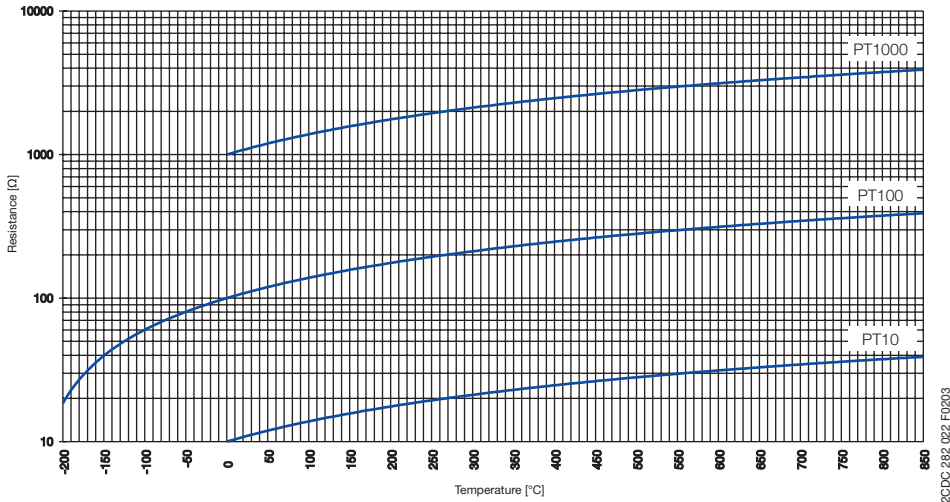

4

CC-U/V

Input range selection

Selecting input range by front-face rotary switch	Switch position
0...100 V	1
0...150 V	2
0...250 V	3
0...300 V	4
0...400 V	5
0...450 V	6
0...550 V	7
0...600 V	8

2CDC 282 012 F0204

Example of application

RMS measurement and conversion of a phase-angle controlled voltage signal $L1 = 230\text{ V}$

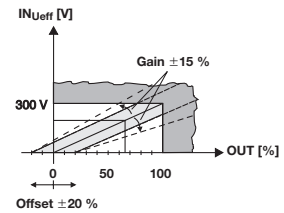
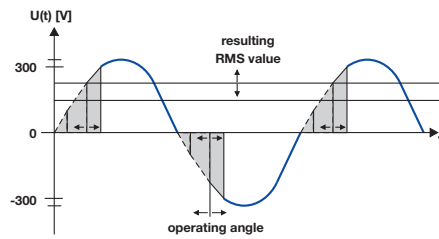

2CDC 282 030 F0203

Analog signal converters - CC-U range

Technical information

CC-U/I

Input range selection

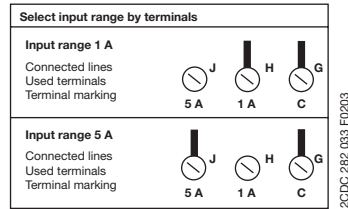

Example of application

RMS measurement and conversion of a current signal

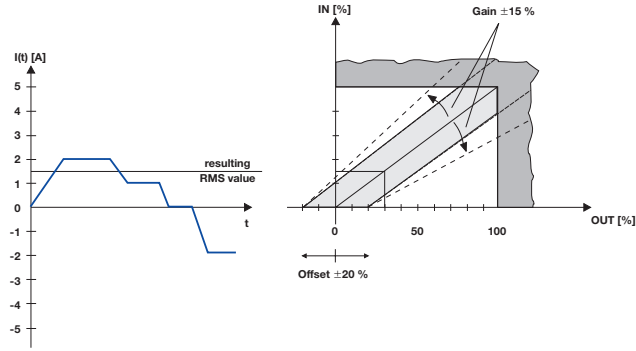

CC-U/TC

Characteristic curve

Thermocouple voltages depending on the temperature

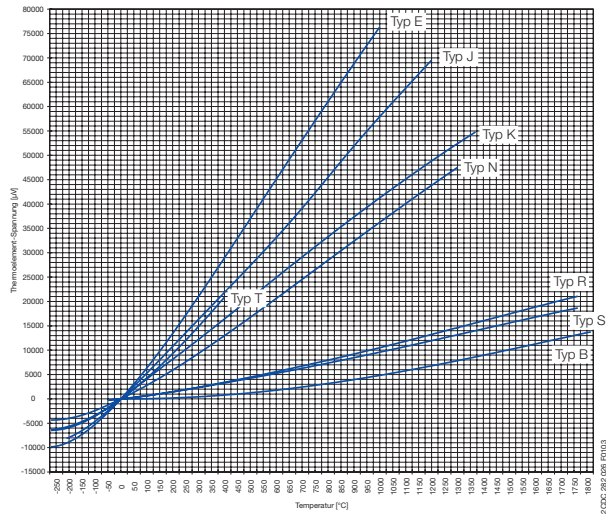

CC-U/TCR with relay output

Function diagrams

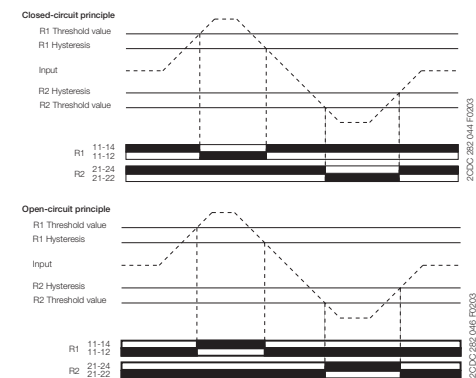

Switching points

Switching points of the output relay depending on the input range, configuration open-circuit principle

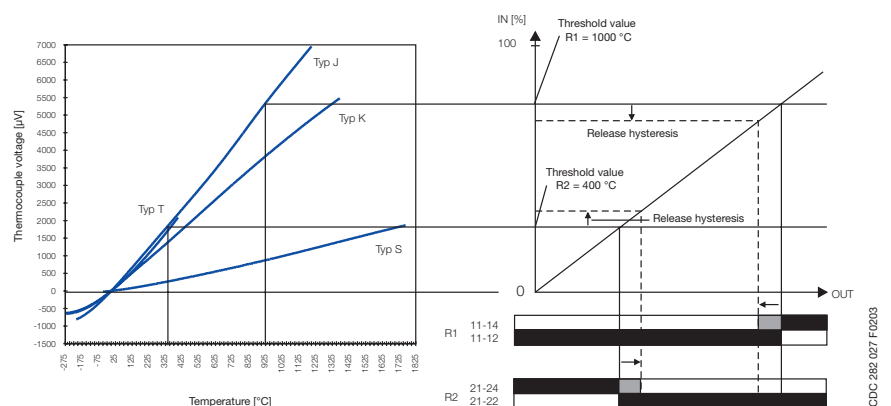

Analog signal converters - CC-U range

Technical data

4

Type	CC-U/STD			CC-U/RTD ³⁾	CC-U/TC	
Input circuits - Analog inputs	J-G-H	Current	Voltage	Potentiometer	Temperature sensors	Thermocouples (IEC 584-1 and 2)
Input signal		0-20 mA 4-20 mA 10-50 mA 0-1 mA	0-100 mV 0-1 V 0-5 V 1-5 V 0-10 V 2-10 V ± 10 V	470 Ω -1 MΩ ²⁾	PT10, PT100, PT1000 (IEL 751 and JICC 1604)	TC.K TC.J TC.T TC.S TC.E TC.N TC.R TC.B
Limitation of input signals		± 55 mA	± 11 V	-	-	-
Rated input range		-	-	-	Max. temperature adjustable: 6-60 °C for PT1000 50-500 °C for PT100 500-850 °C for PT10	refer to temperature specs. of individual thermocouples
Influence of line resistance		-	-	-	0.015 °C/Ω	< 0.01 % / 100 Ω
Gain adjustment range (universal devices)		0.9-110 mA	45 mV - 22 V	-	see DIP switch settings	
Offset adjustment range (universal devices)		-137.5...+62.5 %			± 5 %	± 10 %
Input impedance		for different ranges			-	-
without detection of input signal interruption		51 Ω	6 MΩ	3 GΩ	-	-
with detection of input signal interruption		51 Ω	3.5 MΩ	9.5 GΩ	-	-
Suppression at 50 Hz		-	-	-	-	> 40 dB
Common-mode rejection		-	-	-	120 dB	105 dB
Output circuits - Analog outputs	D-F, A-C	Current			Voltage	
Output signal		0-20 mA, 4-20 mA			0-5 V, 1-5 V, 0-10 V, 2-10 V, ± 10 V	
Output burden		≤ 600 Ω			≥ 4,7 KΩ	
Accuracy ¹⁾		±0.1 % of full-scale			±0.2 % of full-scale	±0.1 % of full-scale
Residual ripple		-			< 0.15 %	-
Response time		200 μs			10 ms	200 ms
Transmission frequency		1 kHz			80 Hz	2 Hz (to -3 dB)
Supply circuits	K-M	DC versions			AC versions	
Rated supply voltage		24-48 V DC			110-240 V AC	
Supply voltage range		24-48 V DC / 24 V AC			110-240 V AC / 100-300 V DC	
Supply voltage tolerance		DC: -15...+15 %			AC: -15...+10 %	
Rated frequency		0 Hz or 50/60 Hz				
Power consumption		2 W at 24 V DC			4.5 VA at 230 V AC	
Indication of operational states		U: green LED				
General data						
Ambient temperature range operation / storage		-20...+60 °C / -40...+80 °C				
Temperature coefficient		±150 ppm/°C			±250 ppm/°C	±200 ppm/°C at min. offset ±400 ppm/°C at max. offset
Mounting position		any				
Mounting		DIN rail (IEC/EN 60715), snap-on mounting / screw mounting with adapter				
Electrical connection						
Wire size	rigid	plug-connector with screw terminals 0.2-2.5 mm ² (24-12 AWG)				
	fine-strand with(out) wire end ferrule	plug-connector with screw terminals 0.2-2.5 mm ² (24-12 AWG)				
Stripping length		7 mm (0.28 inch)				
Tightening torque		0.4 Nm (3.5 lb.in)				
Electromagnetic compatibility						
Interference immunity		EN 61000-6-2				
electrostatic discharge (ESD)	IEC/EN 61000-4-2	Level 3 (±6 kV / ±8 kV)				
electromagnetic field (HF radiation resistance)	IEC/EN 61000-4-3	10 V/m				
fast transients (Burst)	IEC/EN 61000-4-4	Level 3 (±2 kV / 5 kH)				
powerful impulses (Surge)	IEC/EN 61000-4-5	±2 kV / ±1 kV				
HF line emission	IEC/EN 61000-4-6	10 V				
Interference emission	EN 61000-6-4	Class B				
Isolation data						
Isolation test (between all isolated circuits)		1.5 kV				
Test voltage (between all isolated circuits)		1.5 kV / 50 Hz				

¹⁾ Includes non-linearity and factory setting, influenced by supply voltage and output load.

²⁾ Detection of an input signal break (fail safe) and resistance > 10 kΩ results in a linearity of ±0.2 %.

³⁾ When connecting a 2-wire sensor, the terminals J and H have to be jumpered.

Approvals see "Overview" on page 253

Analog signal converters - CC-U range

Technical data

Type	CC-U/STDR		CC-U/TCR
Input circuits - Analog inputs	J-H	Current	Voltage
Measuring signal / input range		0-20 mA 4-20 mA	0-1 V / 1-5 V 0-10 / ±10 V
Input resistance		approx. 50 Ω	approx. 1.5 MΩ
Adjustable threshold		2-100 % of selected input range	
Adjustable hysteresis		5-50 % of threshold	
Repeat accuracy (constant parameters)		±0.5 % of full-scale	
Output circuits - Relay outputs	E-D-F, B-C-A	Relay, 2 c/o contacts	
Rated switching voltage		250 V AC	
Rated switching current	AC-12 (resistive) 230 V	4 A	
	AC-15 (inductive) 230 V	3 A	
	DC-12 (resistive) 24 V	4 A	
	DC-13 (inductive) 24 V	2 A	
AC rating (UL 508)	Utilization category (Control Circuit Rating Code)	B 300	
	max. rated operational voltage	300 V AC	
	max. continuous thermal current at B 300	5 A	
	max. making/breaking apparent power at B 300	3600/360 VA	
Minimum switching voltage		12 V	
Minimum switching current / power		10 mA / 0.6 VA (W)	
Response time		10 ms	
Mechanical lifetime		30 x 10 ⁶ switching cycles	
Electrical lifetime	at AC-12, 230 V, 4 A	0.1 Mio. switching cycles	
Supply circuits	K-M	DC versions	AC versions
Rated supply voltage		24-48 V DC	110-240 V AC
Supply voltage range		24-48 V DC / 24 V AC	110-240 V AC / 100-300 V DC
Supply voltage tolerance		DC: -15...+15 %	AC: -15...+10 %
Rated frequency		0 Hz or 50/60 Hz	
Power consumption		2 W at 24 V DC	4.5 VA at 230 V AC
Indication of operational states			
Supply voltage		U: green LED	
1st / 2nd output relay energized		R1: yellow LED / R2: yellow LED	
General data			
Ambient temperature range	operation / storage	-20...+60 °C / -40...+80 °C	
Temperature coefficient		±300 ppm/°C	
Mounting position		any	
Mounting		DIN rail (IEC/EN 60715), snap-on mounting / screw mounting with adapter	
Electrical connection			
Wire size	rigid	plug-connector with screw terminals 0.2-2.5 mm ² (24-12 AWG)	
	fine-strand with(out) wire end ferrule	plug-connector with screw terminals 0.2-2.5 mm ² (24-12 AWG)	
Stripping length		7 mm (0.28 inch)	
Tightening torque		0.4 Nm (3.5 lb.in)	
Electromagnetic compatibility			
Interference immunity		EN 61000-6-2	
electrostatic discharge (ESD)	IEC/EN 61000-4-2	Level 3 (±6 kV / ±8 kV)	
electromagnetic field (HF radiation resistance)	IEC/EN 61000-4-3	10 V/m	
fast transients (Burst)	IEC/EN 61000-4-4	Level 3 (±2 kV / 5 kHz)	
powerful impulses (Surge)	IEC/EN 61000-4-5	±2 kV / ±1 kV	
HF line emission	IEC/EN 61000-4-6	10 V	
Interference emission	EN 61000-6-4	Class B	
Isolation data			
Insulation voltage (between all isolated circuits)		2.5 kV	
Test voltage (between all isolated circuits)		2.5 kV	

¹⁾ When connecting a 2-wire sensor, the terminals J and H have to be jumpered.
Approvals see "Overview" on page 253

Analog signal converters - CC-U range

Technical data

4

Type		CC-U/I	CC-U/V
Input circuits - Analog inputs	J-G-H	any current signals, RMS measurement	any voltage signals, RMS measurement
Rated input range		0-1 A 0-5 A	0-100 V, 0-150V, 0-250 V 0-300 V, 0-400 V, 0-450 V 0-550 V, 0-600 V
Measuring frequency		0-600 Hz	
Overload capacity of inputs	input range 1	$10 \times I_{Nom}$ (10 A) for max. 2 s	-
	input range 2	$10 \times I_{Nom}$ (50 A) for max. 2 s	-
Gain adjustment range		±15 %	
Offset adjustment range		±20 %	
Input impedance / resistance		1A: 60 mΩ, 5A: 12 mΩ	> 800 kΩ
Output circuits - Analog outputs	D-F, A-C	Current	Voltage
Output signal		0-20 mA, 4-20 mA	0-5 V, 1-5 V, 0-10 V, 2-10 V, ± 10 V
Output load		≤ 600 Ω	≥ 4.7 kΩ
Accuracy ¹⁾		±0.5 % of full-scale	
Temperature coefficient		±250 ppm/°C max.	±300 ppm/°C max.
Residual ripple		< 0.15 %	
Response time		150 ms	
Supply circuits	K-M	DC versions	AC versions
Rated supply voltage		24-48 V DC	110-240 V AC
Supply voltage range		24-48 V DC, 24 V AC	110-240 V AC, 100-300 V DC
Supply voltage tolerance		DC: -15...+15 %	AC: -15...+10 %
Rated frequency		0 Hz or 50/60 Hz	
Power consumption		2 W at 24 V DC	4.5 VA at 230 V AC
Indication of operational states		U: green LED	
Supply voltage		U: green LED	
General data			
Ambient temperature range	operation / storage	-20...+60 °C / -40...+80 °C	
Mounting position		any	
Mounting		DIN rail (IEC/EN 60715), snap-on mounting / screw mounting with adapter	
Electrical connection			
Wire size	rigid	plug-connector with screw terminals 0.2-2.5 mm ² (24-12 AWG)	
	fine-strand with(out) wire end ferrule	plug-connector with screw terminals 0.2-2.5 mm ² (24-12 AWG)	
Stripping length		7 mm (0.28 inch)	
Tightening torque		0.4 Nm (3.5 lb.in)	
Standards			
Product standard		-	
Low Voltage directive		2006/95/EC	
EMC directive		2004/108/EC	
RoHS directive		2011/65/EC	
Electromagnetic compatibility			
Interference immunity		EN 61000-6-2	
electrostatic discharge (ESD)	IEC/EN 61000-4-2	Level 3 (±6 kV / ±8 kV)	
electromagnetic field (HF radiation resistance)	IEC/EN 61000-4-3	10 V/m	
fast transients (Burst)	IEC/EN 61000-4-4	Level 3 (±2 kV / 5 kHz)	
powerful impulses (Surge)	IEC/EN 61000-4-5	±2 kV / ±1 kV	
HF line emission	IEC/EN 61000-4-6	10 V	
Interference emission	EN 61000-6-4	Class B	
Isolation data			
Insulation voltage (between all isolated circuits)		1.5 kV	
Test voltage (between all isolated circuits)		1.5 kV / 50 Hz	

¹⁾ Includes non-linearity and factory setting, influenced by supply voltage and output load.
Approvals see "Overview" on page 253

Analog signal converters - CC-U range

Technical diagr., Connection diagr., Dimensional drawings

Technical diagrams Load limit curves CC-U/xxR

Resistive AC load

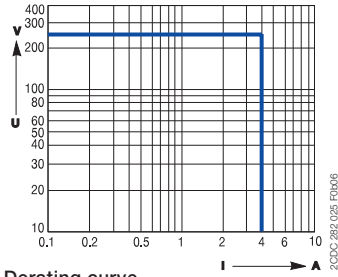

Resistive DC load

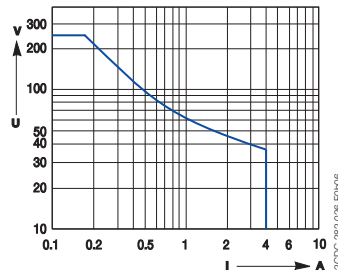

Derating curve

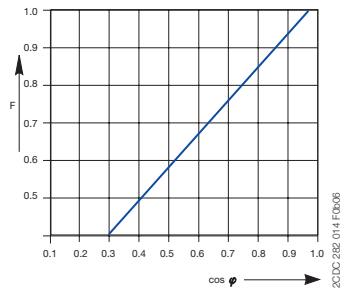

Connection diagram CC-U/x Width 22.5 mm (0.89 in)



4

Dimensional drawings Dimensions in mm and inches

CC-U/x , CC-U/xR

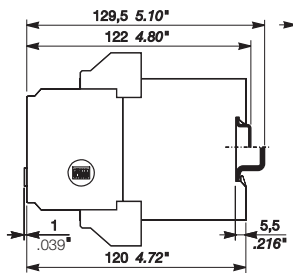

Interface relays and optocouplers

Product group picture

5

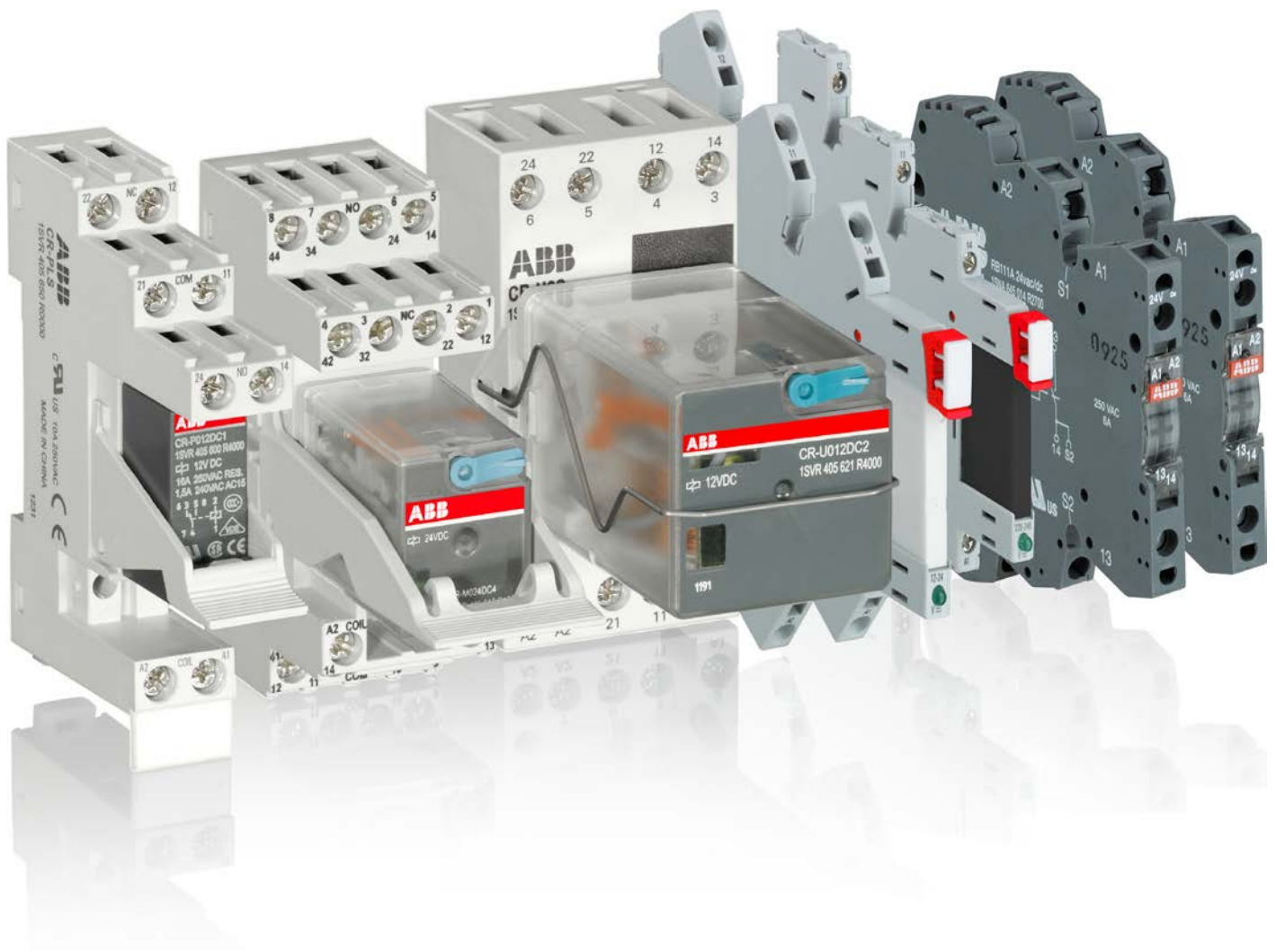

Interface relays and optocouplers

Table of contents

Interface Relays and Optocouplers	
Interface relays and optocouplers	280
Benefits and advantages	281
Benefits and advantages, approvals	282
Pluggable interface relays	284
Table of contents	284
Socket types	285
Ordering details - CR-S range	286
Ordering details - CR-P range	287
Ordering details - CR-M range	288
Ordering details CR-P/M functional modules	291
Ordering details - CR-U range	292
Ordering details - CR-U accessories	293
Technical data - CR-P, CR-M, CR-U	294
Technical data, load limit curves - CR-P, CR-M, CR-U	296
Technical data - Sockets for CR-P and CR-M	297
Technical data - Sockets for CR-U	298
Technical data - CR-S range	299
Technical data - CR-S range sockets	300
Load limit curves	301
Connection diagrams, Dimensional drawings	302
Dimensional drawings	303
Boxed interface relays and optocouplers R600 range	306
Table of contents	306
Overview	307
Benefits and advantages	308
Boxed interface relays R600 range	309
Selection	309
Ordering details	311
Connection diagrams	313
Technical data	314
Dimensional drawings, Load limit curves	317
Boxed interface optocouplers R600 range	319
Selection	319
Ordering details	320
Connection diagrams, Dimensional drawings, Load limit curves	321
Technical data	322
Technical data, Dimensions	324

Interface relays and optocouplers

Benefits and advantages

Slim relays and optocouplers CR-S Range



- Standard slim relays (5 mm), optocouplers (5 mm), sockets (6.2 mm) and accessories
- Combination of 9 different rated control supply voltages possible:
 - DC versions: 5 V, 12 V, 24 V
 - AC/DC versions: 12 V, 24 V, 48 V, 60 V, 110 V, 230 V
- Output relay: 1 c/o (SPDT) contact (6 A), standard and gold-plated
- Output optocoupler: Transistor 100 mA - 48 V DC, MOS-FET 2 A - 24 V DC, Triac 2 A - 240 V AC
- Cadmium-free contact material
- All sockets with LED
- Screw and spring connection terminals
- Jumper bar (red, black, blue), marker and separator available as accessories

Pluggable pcb relays CR-P



- 9 different coil voltages
 - DC versions: 12 V, 24 V, 48 V, 110 V
 - AC versions: 24 V, 48 V, 110 V, 120 V, 230 V
- Output contacts:
 - 1 c/o contact (16 A) or
 - 2 c/o contacts (8 A)
 - optionally equipped with gold contacts
- Logical or standard sockets
- Cadmium-free contact material
- Width of socket: 15.5 mm
- Pluggable function modules
 - Reverse polarity protection/Free wheeling diode
 - LED indication
 - RC elements
 - Overvoltage protection

Pluggable miniature relays CR-M



- 2 different coil voltages
 - DC versions: 12 V, 24 V, 48 V, 60 V, 110 V, 125 V, 220 V
 - AC versions: 24 V, 48 V, 110 V, 120 V, 230 V
- Output contacts
 - 2 c/o contacts (12 A) or
 - 3 c/o contacts (10 A) or
 - 4 c/o contacts (6 A)
 - optionally equipped with gold contacts, LED and free wheeling diode
- Integrated test button for manual actuation and locking of the output contacts (blue = DC, orange = AC) that can be removed if necessary
- With or without integrated LED
- Logical or standard sockets
- Cadmium-free contact material
- Width on socket: 27 mm
- Pluggable function modules
 - Reverse polarity protection/Free wheeling diode
 - LED indication
 - RC elements
 - Overvoltage protection

Pluggable universal relays CR-U



- 12 different coil voltages
 - DC versions: 12 V, 24 V, 48 V, 110 V, 125 V, 220 V
 - AC versions: 24 V, 48 V, 60 V, 110 V, 120 V, 230 V
- Output contacts
 - 2 c/o contacts (10 A) or
 - 3 c/o contacts (10 A)
- Integrated test button for manual actuation and locking of the output contacts (blue = DC, orange = AC) that can be removed if necessary
- With or without integrated LED
- Cadmium-free contact material
- Width on socket: 38 mm
- Pluggable function modules
 - Reverse polarity protection/Free wheeling diode
 - LED indication
 - RC elements
 - Overvoltage protection
 - Multifunction time module

Interface relays and optocouplers

Benefits and advantages, approvals

R600 series interface relays and optocouplers



- Boxed slim relays and optocouplers modules 6 mm or 12 mm
- 8 different rated control supply voltages:
DC versions: 5 V, 12 V, 24 V
AC/DC versions: 24 V, 48-60 V, 115 V, 230 V, 60-230 V
- Output relay: 1 n/c contact, 1 n/o contact, 1 c/o (SPDT) contact, 2 c/o (SPDT) contacts
Output optocoupler: Transistor 100 mA - 58 V DC. MOS-FET 2 A / 5 A - 58 V DC, Triac 1 A / 2 A - 230 V AC
- Devices with output contacts protected by built in RC circuit, which result in increased contact life
- Devices with leakage current protection on the input side
- All products with LED for the indication of the operational state
- Screw or spring-type terminals
- Jumper bars and separator end section as accessories

Approvals and marks

- existing
- pending

Approvals		Relays						Sockets						Modules		
		CR-S		CR-P	CR-M	CR-U	R600	CR-S sockets	CR-PLS CR-PSS	CR-PLC	CR-M..L. CR-M..SS	CR-M..SF	CR-U..E CR-U..E	CR-U..SM	CR-P/M	CR-U
		Relays	Optocouplers													
	ANSI/UL 508	■	■	■	■	■	■	■	■	■	■	■	■	■	■	■ ⁶⁾
	CAN/CSA C22.2 No.14	■	■	■	■	■	■	■ ¹⁾	■	■	■ ²⁾	■	■ ³⁾	■	■	■ ⁶⁾
	CAN/CSA C22.2 No.14	■		■	■	■	■									
	VDE	■ ⁸⁾		■	■ ⁴⁾	■	■ ⁸⁾									
	EAC	■		■	■	■	■	■	■	■	■	■	■	■	■	■
	Lloyds Register				■ ⁵⁾	■										
	CCC			■	■	■										
	CQC	■														
	RMRS			■	■ ⁷⁾	■ ⁷⁾	■	■	■	■	■	■	■	■	■	■
Marks																
	CE	■	■	■	■	■	■	■	■	■	■	■	■	■	■	■

¹⁾ except CR-PLSx
²⁾ except CR-M...LC
³⁾ except CR-U3E
⁴⁾ except 125 V DC devices
⁵⁾ only devices with 4 c/o contacts
⁶⁾ except CR-U61D, CR-U61DV
⁷⁾ except 60 V and 125 V devices
⁸⁾ only relays and sockets with screw terminals

Pluggable interface relays

Product group picture

5

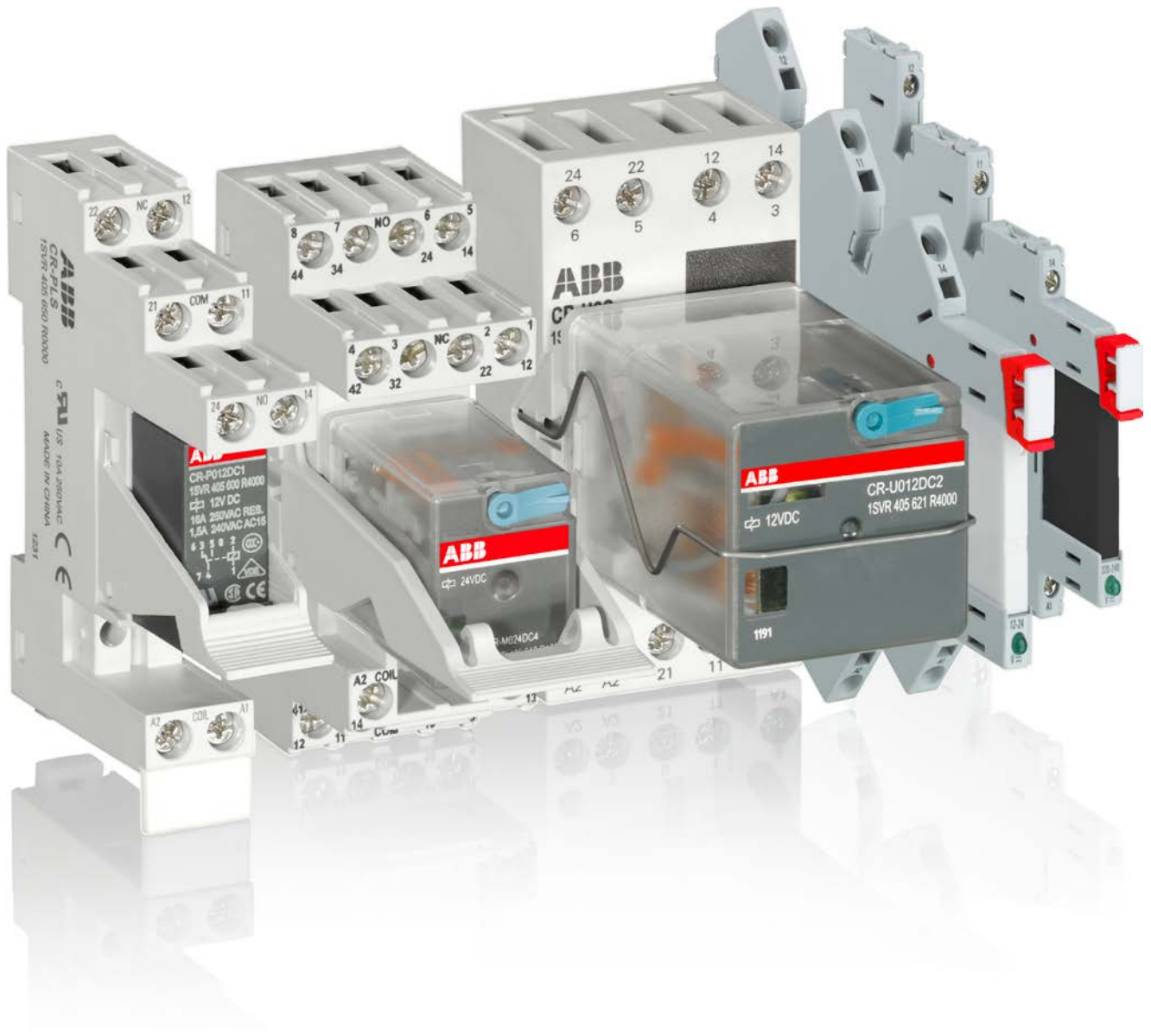

Pluggable interface relays

Table of contents

Pluggable interface relays

Pluggable interface relays	284
Table of contents	284
Socket types	285
Ordering details - CR-S range	286
Ordering details - CR-P range	287
Ordering details - CR-M range	288
Ordering details CR-P/M functional modules	291
Ordering details - CR-U range	292
Ordering details - CR-U accessories	293
Technical data - CR-P, CR-M, CR-U	294
Technical data, load limit curves - CR-P, CR-M, CR-U	296
Technical data - Sockets for CR-P and CR-M	297
Technical data - Sockets for CR-U	298
Technical data - CR-S range	299
Technical data - CR-S range sockets	300
Load limit curves	301
Connection diagrams, Dimensional drawings	302
Dimensional drawings	303

Pluggable interface relays

Socket types

Kind of connecting terminals

Kinds of sockets

Standard sockets - Position of connecting terminals:
Coil connection (A1-A2) on lower socket side, contact connections (n/o and n/c contacts) on the lower and upper socket side.

Logical sockets - Position of connecting terminals:
Coil connection (A1-A2) on lower socket side, all contact connections (common contacts, n/o and n/c contacts) on upper socket side.

Details see connection diagrams

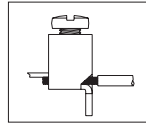

Screw type

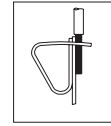

Spring type

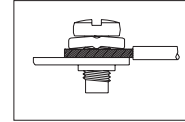

Fork type

CR-S Range

5

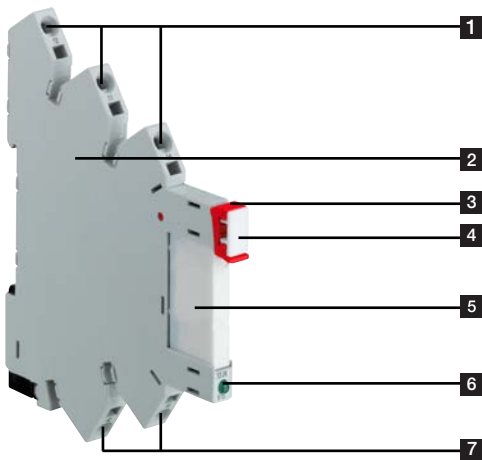

- 1 Output contacts
- 2 Socket
- 3 Relay holder
- 4 Marker
- 5 Interface relay
- 6 LED green: Control supply voltage applied
- 7 Control supply voltage

CR-P range

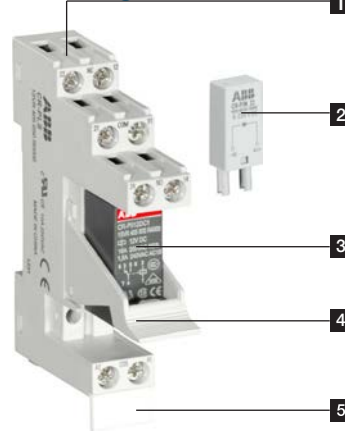

- 1 Socket
- 2 Pluggable function module
- 3 Interface relay
- 4 Holder
- 5 Marker label

CR-M range

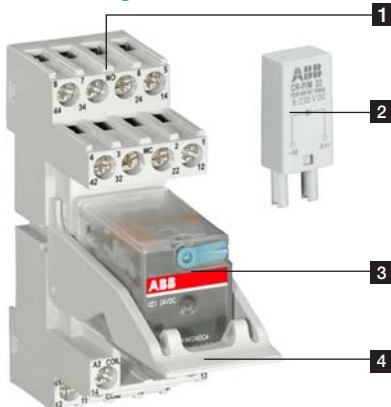

- 1 Socket
- 2 Pluggable function module
- 3 Interface relay
- 4 Holder

CR-P range



- 1 Socket
- 2 Pluggable function module
- 3 Interface relay
- 4 Holder

Pluggable interface relays

Ordering details - CR-S range



2CDC 291 005 S0014

CR-S Interface relay



2CDC 291 003 S0016

CR-S optocoupler

S = screw connection type
Z = spring connection type

Ordering details - CR-S range pluggable interface relays

Rated control supply voltage	Outputs	Contact ratings	Type	Order code	Price	Pkg qty	Weight (1 pce) kg (lb)
5 V DC	1 c/o (SPDT) standard contacts	250 V, 6 A	CR-S005VDC1R	1SVR405501R1010		10	0.005 (0.011)
12 V DC			CR-S012VDC1R	1SVR405501R2010			
24 V DC			CR-S024VDC1R	1SVR405501R3010			
48 V DC			CR-S048VDC1R	1SVR405501R4010			
60 V DC			CR-S060VDC1R	1SVR405501R5010			
5 V DC	1 c/o (SPDT) gold plated contacts	12 V, 250 mA (3W) ¹⁾	CR-S005VDC1RG	1SVR405501R1020		10	0.005 (0.011)
12 V DC			CR-S012VDC1RG	1SVR405501R2020			
24 V DC			CR-S024VDC1RG	1SVR405501R3020			
48 V DC			CR-S048VDC1RG	1SVR405501R4020			
60 V DC			CR-S060VDC1RG	1SVR405501R5020			

Ordering details - CR-S range pluggable optocoupler

Rated control supply voltage	Outputs	Type	Order code	Price	Pkg qty	Weight (1 pce) kg (lb)
24 V DC	Transistor, 100 mA - 48 V DC	CR-S024VDC1TRA	1SVR405510R3050		10	0.004 (0.009)
	MOS-FET, 2 A - 24 V DC	CR-S024VDC1MOS	1SVR405510R3060			
	Triac, 2 A - 240 V AC	CR-S024VDC1TRI	1SVR405510R3070			

Ordering details - CR-S range complete interface relays (relay + socket)

Rated control supply voltage	Outputs	Contact ratings	Type	Order code	Price	Pkg qty	Weight (1 pce) kg (lb)
24 V AC/DC	1 c/o (SPDT) standard contacts	250 V, 6 A	CR-S024VADC1CRS	1SVR405541R3110		10	0.03 (0.066)
			CR-S024VADC1CRZ	1SVR405541R3210			
110 V AC/DC			CR-S110VADC1CRS	1SVR405541R6110			
			CR-S110VADC1CRZ	1SVR405541R6210			
230 V AC/DC			CR-S230VADC1CRS	1SVR405541R7110			
			CR-S230VADC1CRZ	1SVR405541R7210			
24 V AC/DC	1 c/o (SPDT) gold plated contacts	12 V, 250 mA (3W) ¹⁾	CR-S024VADC1CRGS	1SVR405541R3120		10	0.03 (0.066)
			CR-S024VADC1CRGZ	1SVR405541R3220			
110 V AC/DC			CR-S110VADC1CRGS	1SVR405541R6120			
			CR-S110VADC1CRGZ	1SVR405541R6220			
230 V AC/DC			CR-S230VADC1CRGS	1SVR405541R7120			
			CR-S230VADC1CRGZ	1SVR405541R7220			

¹⁾ If specified maximum values exceeded, the gold plating is destroyed. The maximum values of the standard contacts are then valid.

Ordering details - CR-S range sockets

Rated control supply voltage	Connection type	Type	Order code	Price	Pkg qty	Weight (1 pce) kg (lb)
6-24 V DC	Screw	CR-S006/024VDC1SS	1SVR405521R1100		10	0.025 (0.055)
	Spring	CR-S006/024VDC1SZ	1SVR405521R1200			
12-24 V AC/DC	Screw	CR-S012/024VADC1SS	1SVR405521R3100		10	0.025 (0.055)
	Spring	CR-S012/024VADC1SZ	1SVR405521R3200			
48-60 V AC/DC	Screw	CR-S048/060VADC1SS	1SVR405521R5100		10	0.025 (0.055)
	Spring	CR-S048/060VADC1SZ	1SVR405521R5200			
110-125 V AC/DC	Screw	CR-S110/125VADC1SS	1SVR405521R6100		10	0.025 (0.055)
	Spring	CR-S110/125VADC1SZ	1SVR405521R6200			
220-240 V AC/DC	Screw	CR-S220/240VADC1SS	1SVR405521R7100		10	0.025 (0.055)
	Spring	CR-S220/240VADC1SZ	1SVR405521R7200			

Ordering details - CR-S range accessories

Version	Type	Order code	Price	Pkg qty	Weight (1 pce) kg (lb)
Jumper bar 20 pole, blue color	CR-SJB20-BLUE	1SVR405598R0700		10	0.008 (0.018)
Jumper bar 20 pole, red color	CR-SJB20-RED	1SVR405598R0800			
Jumper bar 20 pole, black color	CR-SJB20-BLACK	1SVR405598R0900			
Marker block	CR-SM	1SNB041391R0610		10	0.0036 (0.0079)
Separator	CR-SSEP	1SVR405599R0000		10	0.012 (0.026)



Further documentation
CR-S Range on www.abb.com

Pluggable interface relays

Ordering details - CR-P range



CR-P

2CDC291 046 F0004



CR-PLS

2CDC291 006 F0011



CR-PJ

2CDC291 004 F0007

Ordering details - CR-P range

Rated control supply voltage	Outputs	Contact ratings	Type	Order code	Price	Pkg	Weight (1 pce)
						qty	kg (lb)
12 V DC	1 c/o (SPDT)	250 V, 16 A	CR-P012DC1	1SVR405600R4000		10	0.014 (0.031)
24 V DC			CR-P024DC1	1SVR405600R1000			
48 V DC			CR-P048DC1	1SVR405600R6000			
110 V DC			CR-P110DC1	1SVR405600R8000			
24 V AC			CR-P024AC1	1SVR405600R0000			
48 V AC			CR-P048AC1	1SVR405600R5000			
110 V AC			CR-P110AC1	1SVR405600R7000			
120 V AC			CR-P120AC1	1SVR405600R2000			
230 V AC			CR-P230AC1	1SVR405600R3000			
12 V DC	2 c/o (SPDT)	250 V, 8 A	CR-P012DC2	1SVR405601R4000		10	0.014 (0.031)
24 V DC			CR-P024DC2	1SVR405601R1000			
48 V DC			CR-P048DC2	1SVR405601R6000			
110 V DC			CR-P110DC2	1SVR405601R8000			
24 V AC			CR-P024AC2	1SVR405601R0000			
48 V AC			CR-P048AC2	1SVR405601R5000			
110 V AC			CR-P110AC2	1SVR405601R7000			
120 V AC			CR-P120AC2	1SVR405601R2000			
230 V AC			CR-P230AC2	1SVR405601R3000			

Ordering details - CR-P range with gold contacts

Rated control supply voltage	Outputs	Contact ratings	Type	Order code	Price	Pkg	Weight (1 pce)
						qty	kg (lb)
24 V DC	2 c/o (SPDT) gold contact	250 V, 8 A	CR-P024DC2	1SVR405606R1000		10	0.014 (0.031)
24 V AC			CR-P024AC2G	1SVR405606R0000			
110 V AC			CR-P110AC2G	1SVR405606R7000			
230 V AC			CR-P230AC2G	1SVR405606R3000			

Ordering details - Accessories

Version	Connection terminal	Type	Order code	Price	Pkg	Weight (1 pce)
					qty	kg (lb)
Logical socket with protective separation	screw	CR-PLS	1SVR405650R0000		10	0.045 (0.099)
		CR-PLSx	1SVR405650R0100			0.043 (0.095)
Logical socket	spring	CR-PLC	1SVR405650R0200		10	0.042 (0.093)
	screw	CR-PSS	1SVR405650R1000			0.038 (0.084)
Standard socket	screw	CR-PSS	1SVR405650R1000		10	0.002 (0.004)
Plastic holder for socket		CR-PH	1SVR405659R0000		10	0.018 (0.040)
Jumper bar for sockets with screw connection		CR-PJ	1SVR405658R5000		10	0.0002 (0.0004)
Marker		CR-PM	1SVR405658R0000		10	



Further documentation
CR-P range on www.abb.com

Pluggable interface relays

Ordering details - CR-M range



CR-M

2CDC 291 00Z RV015

Ordering details - CR-M range without LED

Rated control supply voltage	Outputs	Contact ratings	Type	Order code	Price	Pkg qty	Weight (1 pce)				
							kg (lb)				
12 V DC	2 c/o (SPDT)	250 V, 12 A	CR-M012DC2	1SVR405611R4000		10	0.033 (0.073)				
24 V DC			CR-M024DC2	1SVR405611R1000							
48 V DC			CR-M048DC2	1SVR405611R6000							
60 V DC			CR-M060DC2	1SVR405611R4200							
110 V DC			CR-M110DC2	1SVR405611R8000							
125 V DC			CR-M125DC2	1SVR405611R8200							
220 V DC			CR-M220DC2	1SVR405611R9000							
24 V AC			CR-M024AC2	1SVR405611R0000							
48 V AC			CR-M048AC2	1SVR405611R5000							
110 V AC			CR-M110AC2	1SVR405611R7000							
120 V AC			CR-M120AC2	1SVR405611R2000							
230 V AC			CR-M230AC2	1SVR405611R3000							
12 V DC			3 c/o (SPDT)	250 V, 10 A	CR-M012DC3			1SVR405612R4000		10	0.033 (0.073)
24 V DC					CR-M024DC3			1SVR405612R1000			
48 V DC	CR-M048DC3	1SVR405612R6000									
60 V DC	CR-M060DC3	1SVR405612R4200									
110 V DC	CR-M110DC3	1SVR405612R8000									
125 V DC	CR-M125DC3	1SVR405612R8200									
220 V DC	CR-M220DC3	1SVR405612R9000									
24 V AC	CR-M024AC3	1SVR405612R0000									
48 V AC	CR-M048AC3	1SVR405612R5000									
60 V AC	CR-M060AC3	1SVR405612R5200									
110 V AC	CR-M110AC3	1SVR405612R7000									
120 V AC	CR-M120AC3	1SVR405612R2000									
230 V AC	CR-M230AC3	1SVR405612R3000									
12 V DC	4 c/o (SPDT)	250 V, 6 A			CR-M012DC4	1SVR405613R4000		10	0.033 (0.073)		
24 V DC			CR-M024DC4	1SVR405613R1000							
48 V DC			CR-M048DC4	1SVR405613R6000							
60 V DC			CR-M060DC4	1SVR405613R4200							
110 V DC			CR-M110DC4	1SVR405613R8000							
125 V DC			CR-M125DC4	1SVR405613R8200							
220 V DC			CR-M220DC4	1SVR405613R9000							
24 V AC			CR-M024AC4	1SVR405613R0000							
48 V AC			CR-M048AC4	1SVR405613R5000							
110 V AC			CR-M110AC4	1SVR405613R7000							
120 V AC			CR-M120AC4	1SVR405613R2000							
230 V AC			CR-M230AC4	1SVR405613R3000							



Pluggable interface relays

Ordering details - CR-M range



CR-M

2CDC 291 102 F0015

5

Ordering details - CR-M range with LED

Rated control supply voltage	Outputs	Contact ratings	Type	Order code	Price	Pkg	Weight
						qty	(1 pce) kg (lb)
12 V DC	2 c/o (SPDT)	250 V, 12 A	CR-M012DC2L	1SVR405611R4100		10	0.033 (0.073)
24 V DC			CR-M024DC2L	1SVR405611R1100			
48 V DC			CR-M048DC2L	1SVR405611R6100			
60 V DC			CR-M060DC2L	1SVR405611R4300			
110 V DC			CR-M110DC2L	1SVR405611R8100			
125 V DC			CR-M125DC2L	1SVR405611R8300			
220 V DC			CR-M220DC2L	1SVR405611R9100			
24 V AC			CR-M024AC2L	1SVR405611R0100			
48 V AC			CR-M048AC2L	1SVR405611R5100			
110 V AC			CR-M110AC2L	1SVR405611R7100			
120 V AC	CR-M120AC2L	1SVR405611R2100					
230 V AC	CR-M230AC2L	1SVR405611R3100					
12 V DC	3 c/o (SPDT)	250 V, 10 A	CR-M012DC3L	1SVR405612R4100		10	0.033 (0.073)
24 V DC			CR-M024DC3L	1SVR405612R1100			
48 V DC			CR-M048DC3L	1SVR405612R6100			
60 V DC			CR-M060DC3L	1SVR405612R4300			
110 V DC			CR-M110DC3L	1SVR405612R8100			
125 V DC			CR-M125DC3L	1SVR405612R8300			
220 V DC			CR-M220DC3L	1SVR405612R9100			
24 V AC			CR-M024AC3L	1SVR405612R0100			
48 V AC			CR-M048AC3L	1SVR405612R5100			
110 V AC			CR-M110AC3L	1SVR405612R7100			
120 V AC	CR-M120AC3L	1SVR405612R2100					
230 V AC	CR-M230AC3L	1SVR405612R3100					
12 V DC	4 c/o (SPDT)	250 V, 6 A	CR-M012DC4L	1SVR405613R4100		10	0.033 (0.073)
24 V DC			CR-M024DC4L	1SVR405613R1100			
48 V DC			CR-M048DC4L	1SVR405613R6100			
60 V DC			CR-M060DC4L	1SVR405613R4300			
110 V DC			CR-M110DC4L	1SVR405613R8100			
125 V DC			CR-M125DC4L	1SVR405613R8300			
220 V DC			CR-M220DC4L	1SVR405613R9100			
24 V AC			CR-M024AC4L	1SVR405613R0100			
48 V AC			CR-M048AC4L	1SVR405613R5100			
110 V AC			CR-M110AC4L	1SVR405613R7100			
120 V AC	CR-M120AC4L	1SVR405613R2100					
230 V AC	CR-M230AC4L	1SVR405613R3100					

Ordering details - CR-M range with LED and free-wheeling diode

Rated control supply voltage	Outputs	Contact ratings	Type	Order code	Price	Pkg	Weight
						qty	(1 pce) kg (lb)
24 V DC	4 c/o (SPDT)	250 V, 6 A	CR-M024DC4LD	1SVR405614R1100		10	0.033 (0.073)

Ordering details - CR-M range with gold contacts

Rated control supply voltage	Outputs	Contact ratings	Type	Order code	Price	Pkg	Weight
						qty	(1 pce) kg (lb)
24 V DC	4 c/o (SPDT)	250 V, 6 A	CR-M024DC4G	1SVR405618R1000		10	0.033 (0.073)
24 V AC			CR-M024AC4G	1SVR405618R0000			
110 V AC			CR-M110AC4G	1SVR405618R7000			
230 V AC			CR-M230AC4G	1SVR405618R3000			



Further documentation
CR-M range on www.abb.com

Pluggable interface relays

Ordering details - CR-M range



2CDC 291 002 F0015

CR-M



2CDC 291 009 F0011

CR-M4SS



2CDC 291 005 F0007

CR-MJ

Ordering details – CR-M range with gold contacts and LED

Rated control supply voltage	Outputs	Contact ratings	Type	Order code	Price	Pkg	Weight (1 pce)
						qty	kg (lb)
12 V DC	4 c/o (SPDT)	250 V / 6 A	CR-M012DC4LG	1SVR405618R4100		10	0.033 (0.073)
24 V DC			CR-M024DC4LG	1SVR405618R1100			
48 V DC			CR-M048DC4LG	1SVR405618R6100			
60 V DC			CR-M060DC4LG	1SVR405618R4300			
110 V DC			CR-M110DC4LG	1SVR405618R8100			
125 V DC			CR-M125DC4LG	1SVR405618R8300			
220 V DC			CR-M220DC4LG	1SVR405618R9100			
24 V AC			CR-M024AC4LG	1SVR405618R0100			
48 V AC			CR-M048AC4LG	1SVR405618R5100			
110 V AC			CR-M110AC4LG	1SVR405618R7100			
120 V AC	CR-M120AC4LG	1SVR405618R2100					
230 V AC	CR-M230AC4LG	1SVR405618R3100					

Ordering details – CR-M range with gold contacts, LED and free-wheeling diode

Rated control supply voltage	Outputs	Contact ratings	Type	Order code	Price	Pkg	Weight (1 pce)
						qty	kg (lb)
12 V DC	4 c/o (SPDT)		CR-M012DC4LDG	1SVR405618R4400		10	0.033 (0.073)
24 V DC			CR-M024DC4LDG	1SVR405618R1400			

Ordering details - Accessories

Version	Connection terminal	Type	Order code	Price	Pkg	Weight (1 pce)
					qty	kg (lb)
Logical socket for 2 c/o	screw	CR-M2LS	1SVR405651R1100		10	0.055 (0.121)
Logical socket for 3 c/o		CR-M3LS	1SVR405651R2100			0.062 (0.137)
Logical socket for 2/4 c/o		CR-M4LS	1SVR405651R3100			0.066 (0.146)
Logical socket for 2 c/o	spring	CR-M2LC	1SVR405651R1200		10	0.065 (0.143)
Logical socket for 2/4 c/o		CR-M4LC	1SVR405651R3200			0.066 (0.146)
Standard socket for 2 c/o	screw	CR-M2SS	1SVR405651R1000		10	0.066 (0.146)
Standard socket for 3 c/o		CR-M3SS	1SVR405651R2000			0.068 (0.150)
Standard socket for 2/4 c/o		CR-M4SS	1SVR405651R3000			0.070 (0.154)
Standard socket for 2 c/o	fork type	CR-M2SF	1SVR405651R1300		10	0.040 (0.088)
Standard socket for 2/4 c/o		CR-M4SF	1SVR405651R3300			0.048 (0.106)
Plastic holder		CR-MH	1SVR405659R1000		10	0.003 (0.007)
Metal holder		CR-MH1	1SVR405659R1100		10	0.0005 (0.001)
Jumper bar for sockets with screw connection		CR-MJ	1SVR405658R6000		10	0.029 (0.064)
Marker		CR-MM	1SVR405658R1000		10	0.0005 (0.001)



Further documentation
CR-M range on www.abb.com

Pluggable interface relays

Ordering details CR-P/M functional modules



CR-P/M ...

2CDC 291 005 S0011

Ordering details - CR-P/M range

Rated control supply voltage	Description	Version	Type	Order code	Price	Pkg qty	Weight (1 pce)
							kg (lb)
6-220 V DC	Diode - Reverse polarity protection/free wheeling diode	A1+, A2-	CR-P/M 22	1SVR405651R0000		10	0.003 (0.007)
6-24 V DC	Diode and LED - Reverse polarity protection/free wheeling diode	red, A1+, A2-	CR-P/M 42	1SVR405652R0000		10	0.003 (0.007)
24-60 V DC		green, A1+, A2-	CR-P/M 42V	1SVR405652R1000			
110 V DC		red, A1+, A2-	CR-P/M 42B	1SVR405652R4000			
		green, A1+, A2-	CR-P/M 42BV	1SVR405652R4100			
		red, A1+, A2-	CR-P/M 42C	1SVR405652R9000			
		green, A1+, A2-	CR-P/M 42CV	1SVR405652R9100			
6-24 V AC/DC	Spark quenching		CR-P/M 52B	1SVR405653R0000		10	0.003 (0.007)
24-60 V AC/DC			CR-P/M 52D	1SVR405653R4000			
110 V AC/DC			CR-P/M 52C	1SVR405653R1000			
6-24 V AC/DC	Diode, LED and reverse polarity protection	red, for DC A1+, A2-	CR-P/M 62	1SVR405654R0000		10	0.003 (0.007)
		green, for DC A1+, A2-	CR-P/M 62V	1SVR405654R1000			
24-60 V AC/DC		red, for DC A1+, A2-	CR-P/M 62E	1SVR405654R4000			
		green, for DC A1+, A2-	CR-P/M 62EV	1SVR405654R4100			
110 V DC		red, for DC A1+, A2-	CR-P/M 92	1SVR405654R0100			
110-230 V AC		green, for DC A1+, A2-	CR-P/M 92V	1SVR405654R1100			
6-24 V AC/DC	Varistor and LED Overvoltage protection	red, for DC A1+, A2-	CR-P/M 62C	1SVR405655R0000		10	0.003 (0.007)
		green, for DC A1+, A2-	CR-P/M 62CV	1SVR405655R1000			
24-60 V AC/DC		red, for DC A1+, A2-	CR-P/M 62D	1SVR405655R4000			
		green, for DC A1+, A2-	CR-P/M 62DV	1SVR405655R4100			
110 V DC	Overvoltage protection	red, for DC A1+, A2-	CR-P/M 92C	1SVR405655R0100		10	0.002 (0.004)
110-230 V AC		green, for DC A1+, A2-	CR-P/M 92CV	1SVR405655R1100			
24 V AC			CR-P/M 72	1SVR405656R0000			
115 V AC		CR-P/M 72A	1SVR405656R1000				
230 V AC		CR-P/M 82	1SVR405656R2000				

Connection diagrams

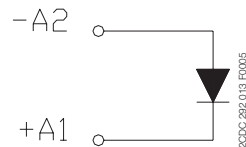

CR-P/M 22

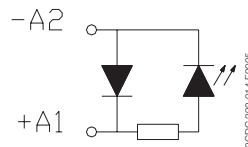

CR-P/M 42, CR-P/M 42C, CR-P/M 42BV, CR-P/M 42B, CR-P/M 42V, CR-P/M 42CV

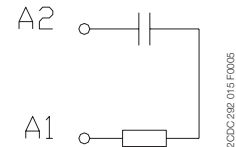

CR-P/M 52B, CR-P/M 52D, CR-P/M 52C

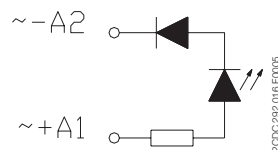

CR-P/M 62, CR-P/M 92, CR-P/M 62E, CR-P/M 62V, CR-P/M 62EV, CR-P/M 92V

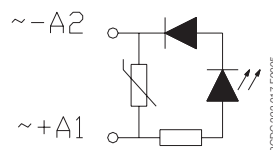

CR-P/M 62C, CR-P/M 92C, CR-P/M 62D, CR-P/M 92C, CR-P/M 62D, CR-P/M 62CV, CR-P/M 92CV

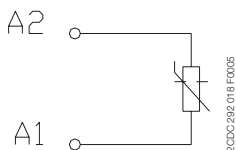

CR-P/M 72, CR-P/M 72A, CR-P/M 82

Pluggable interface relays

Ordering details - CR-U range



2CDC 291 047 F0004

CR-U



2CDC 291 007 S0011

CR-U2S

Ordering details - CR-U range without LED

Rated control supply voltage	Outputs	Contact ratings	Type	Order code	Price	Pkg qty	Weight (1 pce) kg (lb)				
12 V DC	2 c/o (SPDT)	250 V, 10 A	CR-U012DC2	1SVR405621R4000		10	0.083 (0.183)				
24 V DC			CR-U024DC2	1SVR405621R1000							
48 V DC			CR-U048DC2	1SVR405621R6000							
110 V DC			CR-U110DC2	1SVR405621R8000							
220 V DC			CR-U220DC2	1SVR405621R9000							
24 V AC			CR-U024AC2	1SVR405621R0000							
48 V AC			CR-U048AC2	1SVR405621R5000							
110 V AC			CR-U110AC2	1SVR405621R7000							
120 V AC			CR-U120AC2	1SVR405621R2000							
230 V AC			CR-U230AC2	1SVR405621R3000							
12 V DC			3 c/o (SPDT)	250 V, 10 A	CR-U012DC3			1SVR405622R4000		10	0.083 (0.183)
24 V DC					CR-U024DC3			1SVR405622R1000			
48 V DC					CR-U048DC3			1SVR405622R6000			
110 V DC					CR-U110DC3			1SVR405622R8000			
125 V DC	CR-U125DC3	1SVR405622R8200									
220 V DC	CR-U220DC3	1SVR405622R9000									
24 V AC	CR-U024AC3	1SVR405622R0000									
48 V AC	CR-U048AC3	1SVR405622R5000									
60 V AC	CR-U060AC3	1SVR405622R5200									
110 V AC	CR-U110AC3	1SVR405622R7000									
120 V AC	CR-U120AC3	1SVR405622R2000									
230 V AC	CR-U230AC3	1SVR405622R3000									

Ordering details - CR-U range with LED

Rated control supply voltage	Outputs	Contact ratings	Type	Order code	Price	Pkg qty	Weight (1 pce) kg (lb)				
12 V DC	2 c/o (SPDT)	250 V, 10 A	CR-U012DC2L	1SVR405621R4100		10	0.083 (0.183)				
24 V DC			CR-U024DC2L	1SVR405621R1100							
48 V DC			CR-U048DC2L	1SVR405621R6100							
110 V DC			CR-U110DC2L	1SVR405621R8100							
220 V DC			CR-U220DC2L	1SVR405621R9100							
24 V AC			CR-U024AC2L	1SVR405621R0100							
48 V AC			CR-U048AC2L	1SVR405621R5100							
110 V AC			CR-U110AC2L	1SVR405621R7100							
120 V AC			CR-U120AC2L	1SVR405621R2100							
230 V AC			CR-U230AC2L	1SVR405621R3100							
12 V DC			3 c/o (SPDT)	250 V, 10 A	CR-U012DC3L			1SVR405622R4100		10	0.083 (0.183)
24 V DC					CR-U024DC3L			1SVR405622R1100			
48 V DC					CR-U048DC3L			1SVR405622R6100			
110 V DC					CR-U110DC3L			1SVR405622R8100			
220 V DC	CR-U220DC3L	1SVR405622R9100									
24 V AC	CR-U024AC3L	1SVR405622R0100									
48 V AC	CR-U048AC3L	1SVR405622R5100									
110 V AC	CR-U110AC3L	1SVR405622R7100									
120 V AC	CR-U120AC3L	1SVR405622R2100									
230 V AC	CR-U230AC3L	1SVR405622R3100									

Ordering details - Accessories

Version	Type	Order code	Price	Pkg qty	Weight (1 pce) kg (lb)
Socket for 2 c/o and module	CR-U2S	1SVR405670R0000		10	
Socket for 3 c/o and module	CR-U3S	1SVR405660R0000			
Socket for 3 c/o	CR-U3E	1SVR405660R0100			
Socket small for 2 c/o	CR-U2SM	1SVR405670R1100			
Socket small for 3 c/o	CR-U3SM	1SVR405660R1100			
Holder for CR-U socket	CR-UH	1SVR405669R0000			



Further documentation
CR-U range on www.abb.com

Pluggable interface relays

Ordering details - CR-U accessories



CR-U...

2CDC 291 004 S0011



CR-U T

2CDC 291 032 F0005

5

Ordering details - CR-U range

Rated control supply voltage	Description	Version	Type	Order code	Price	Pkg qty	Weight (1 pce)
							kg (lb)
6-220 V DC	Diode - Reverse polarity protection/free wheeling diode	A1+, A2-	CR-U 21	1SVR405661R0000		10	0.007 (0.015)
6-24 V DC	Diode and LED - Reverse polarity protection/free wheeling diode	red, A1+, A2-	CR-U 41	1SVR405662R0000		10	0.007 (0.015)
24-60 V DC		green, A1+, A2-	CR-U 41V	1SVR405662R1000			
110 V DC		red, A1+, A2-	CR-U 41B	1SVR405662R4000			
6-24 V AC/DC		green, A1+, A2-	CR-U 41BV	1SVR405662R4100			
24-60 V AC/DC	Spark quenching	red, A1+, A2-	CR-U 41C	1SVR405662R9000		10	0.007 (0.015)
110 V AC/DC		green, A1+, A2-	CR-U 41CV	1SVR405662R9100			
6-24 V AC/DC	Diode and LED	red, for DC A1+, A2-	CR-U 61	1SVR405664R0000		10	0.007 (0.015)
24-60 V AC/DC		green, for DC A1+, A2-	CR-U 61V	1SVR405664R1000			
110 V DC		red, for DC A1+, A2-	CR-U 61E	1SVR405664R4000			
110-230 V AC		green, for DC A1+, A2-	CR-U 61EV	1SVR405664R4100			
6-24 V AC/DC		red, for DC A1+, A2-	CR-U 91	1SVR405664R0100			
24-60 V AC/DC		green, for DC A1+, A2-	CR-U 91V	1SVR405664R1100			
110 V DC		red, for DC A1+, A2-	CR-U 61C	1SVR405665R0000			
110-230 V AC		green, for DC A1+, A2-	CR-U 61CV	1SVR405665R1000			
24 V AC		red, for DC A1+, A2-	CR-U 61D	1SVR405665R4000			
115 V AC		green, for DC A1+, A2-	CR-U 61DV	1SVR405665R4100			
230 V AC		red, for DC A1+, A2-	CR-U 91C	1SVR405665R0100			
24 V AC		green, for DC A1+, A2-	CR-U 91CV	1SVR405665R1100			
24 V AC	Overvoltage protection, varistor		CR-U 71	1SVR405666R0000		10	0.007 (0.015)
115 V AC			CR-U 71A	1SVR405666R1000			
230 V AC			CR-U 81	1SVR405666R2000			
24-240 V AC/DC	Multifunction time module	pluggable onto CR-U2S and CR-U3S	CR-U T	1SVR405667R0000		10	0.014 (0.031)

Connection diagrams

All CR-U modules can be plugged onto sockets CR-U2S and CR-U3S.

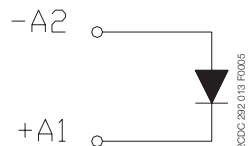

CR-U 21

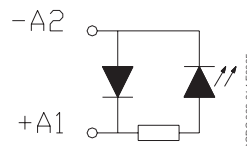

CR-U 41, CR-U 41B, CR-U 41C, CR-U 41V, CR-U 41BV, CR-U 41CV

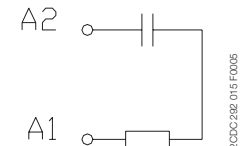

CR-U 51B, CR-U 51C CR-U 51D

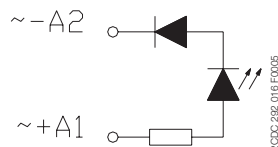

CR-U 61, CR-U 61E, CR-U 91, CR-U 61V, CR-U 61EV, CR-U 91V

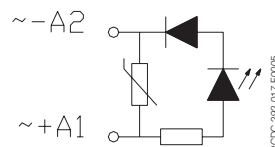

CR-U 61C, CR-U 61CV, CR-U 61D, CR-U 61DV, CR-U 91C, CR-U 91CV

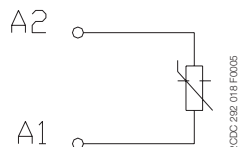

CR-U 71, CR-U 71A, CR-U 81

Pluggable interface relays

Technical data - CR-P, CR-M, CR-U

Input circuit - coil data

CR-P range



	Rated control supply voltage U_s	Rated frequency	Make voltage (at 20 °C)	Maximum voltage (at 55 °C)	Break voltage	Rated power	Coil resistance (at 20 °C)	Tolerance of coil resistance
DC coils	12 V DC	-	8.4 V DC	30.6 V DC	$\geq 0.1 U_s$	0.4-0.48 W	360 Ω	$\pm 10\%$
	24 V DC	-	16.8 V DC	61.2 V DC	$\geq 0.1 U_s$	0.4-0.48 W	1440 Ω	$\pm 10\%$
	48 V DC	-	33.6 V DC	122.4 V DC	$\geq 0.1 U_s$	0.4-0.48 W	5700 Ω	$\pm 10\%$
	110 V DC	-	77 V DC	280 V DC	$\geq 0.1 U_s$	0.4-0.48 W	25200 Ω	$\pm 10\%$
AC coils	24 V AC	50 / 60 Hz	19.2 V AC	28.8 V AC	$\geq 0.15 U_s$	0.75 VA	400 Ω	$\pm 10\%$
	48 V AC	50 / 60 Hz	38.4 V AC	57.6 V AC	$\geq 0.15 U_s$	0.75 VA	1550 Ω	$\pm 10\%$
	110 V AC	50 / 60 Hz	88 V AC	132 V AC	$\geq 0.15 U_s$	0.75 VA	8900 Ω	$\pm 10\%$
	120 V AC	50 / 60 Hz	96 V AC	144 V AC	$\geq 0.15 U_s$	0.75 VA	10200 Ω	$\pm 10\%$
	230 V AC	50 / 60 Hz	184 V AC	276 V AC	$\geq 0.15 U_s$	0.75 VA	38500 Ω	$\pm 10\%$

CR-M range



	Rated control supply voltage U_s	Rated frequency	Make voltage (at 20 °C)	Maximum voltage (at 55 °C)	Break voltage	Rated power	Coil resistance (at 20 °C)	Tolerance of coil resistance
DC coils	12 V DC	-	9.6 V DC	13.2 V DC	$\geq 0.1 U_s$	0.9 W	160 Ω	$\pm 10\%$
	24 V DC	-	19.2 DC	26.4 V DC	$\geq 0.1 U_s$	0.9 W	640 Ω	$\pm 10\%$
	48 V DC	-	38.4 V DC	52.8 V DC	$\geq 0.1 U_s$	0.9 W	2600 Ω	$\pm 10\%$
	60 V DC	-	48 V DC	66 V DC	$\geq 0.1 U_s$	0.9 W	4000 Ω	$\pm 10\%$
	110 V DC	-	88 V DC	121 V DC	$\geq 0.1 U_s$	0.9 W	13600 Ω	$\pm 10\%$
	125 V DC	-	100 V DC	137.5 V DC	$\geq 0.1 U_s$	0.9 W	16000 Ω	$\pm 10\%$
	220 V DC	-	176 V DC	242 V DC	$\geq 0.1 U_s$	0.9 W	54000 Ω	$\pm 10\%$
	AC coils	24 V AC	50 / 60 Hz	19.2 V AC	26.4 V AC	$\geq 0.2 U_s$	1.6 VA	158 Ω
48 V AC		50 / 60 Hz	38.4 V AC	52.8 V AC	$\geq 0.2 U_s$	1.6 VA	640 Ω	$\pm 10\%$
60 V AC		50 / 60 Hz	48 V AC	66 V AC	$\geq 0.2 U_s$	1.6 VA	930 Ω	$\pm 10\%$
110 V AC		50 / 60 Hz	88 V AC	121 V AC	$\geq 0.2 U_s$	1.6 VA	3450 Ω	$\pm 10\%$
120 V AC		50 / 60 Hz	96 V AC	132 V AC	$\geq 0.2 U_s$	1.6 VA	3770 Ω	$\pm 10\%$
230 V AC		50 / 60 Hz	184 V AC	253 V AC	$\geq 0.2 U_s$	1.6 VA	16100 Ω	$\pm 10\%$

CR-U range



	Rated control supply voltage U_s	Rated frequency	Make voltage (at 20 °C)	Maximum voltage (at 55 °C)	Break voltage	Rated power	Coil resistance (at 20 °C)	Tolerance of coil resistance
DC coils	12 V DC	-	9.6 V DC	13.2 V DC	$\geq 0.1 U_s$	1.5 W	110 Ω	$\pm 10\%$
	24 V DC	-	19.2 V DC	26.4 V DC	$\geq 0.1 U_s$	1.5 W	430 Ω	$\pm 10\%$
	48 V DC	-	38.4 V DC	52.8 V DC	$\geq 0.1 U_s$	1.5 W	1750 Ω	$\pm 10\%$
	110 V DC	-	88.0 V DC	121.0 V DC	$\geq 0.1 U_s$	1.5 W	9200 Ω	$\pm 10\%$
	125 V DC	-	100 V DC	137.5 V DC	$\geq 0.1 U_s$	1.5 W	11000 Ω	$\pm 10\%$
	220 V DC	-	176.0 V DC	242.0 V DC	$\geq 0.1 U_s$	1.5 W	37000 Ω	$\pm 10\%$
	AC coils	24 V AC	50 / 60 Hz	19.2 V AC	26.4 V AC	$\geq 0.15 U_s$	2.8 VA (50 Hz) 2.5 VA (60 Hz)	75 Ω
48 V AC		50 / 60 Hz	38.4 V AC	52.8 V AC	$\geq 0.15 U_s$	2.8 VA (50 Hz) 2.5 VA (60 Hz)	305 Ω	$\pm 10\%$
60 V AC		50 / 60 Hz	48.0 V AC	66.0 V AC	$\geq 0.15 U_s$	2.8 VA (50 Hz) 2.5 VA (60 Hz)	475 Ω	$\pm 10\%$
110 V AC		50 / 60 Hz	88.0 V AC	121.0 V AC	$\geq 0.15 U_s$	2.8 VA (50 Hz) 2.5 VA (60 Hz)	1700 Ω	$\pm 10\%$
120 V AC		50 / 60 Hz	96.0 V AC	132.0 V AC	$\geq 0.15 U_s$	2.8 VA (50 Hz) 2.5 VA (60 Hz)	1910 Ω	$\pm 10\%$
230 V AC		50 / 60 Hz	184.0 V AC	253.0 V AC	$\geq 0.15 U_s$	2.8 VA (50 Hz) 2.5 VA (60 Hz)	7080 Ω	$\pm 10\%$

Pluggable interface relays

Technical data - CR-P, CR-M, CR-U

Type		CR-P...1	CR-P...2	CR-M...2	CR-M...3	CR-M...4	CR-U...2	CR-U...3	
Output circuit(s)		11-12/14	11-12/14 21-22/24	11-12/14 21-22/24	11-12/14 21-22/24 31-32/34	11-12/14 21-22/24 31-32/34 41-42/44	11-12/14 31-32/34	11-12/14 21-22/24 31-32/34	
Kind of output		Relay, 1 c/o	Relay, 2 c/o	Relay, 2 c/o	Relay, 3 c/o	Relay, 4 c/o	Relay, 2 c/o	Relay, 3 c/o	
Contact material		AgNi	AgNi AgNi/Au 5 µm	AgNi	AgNi	AgNi AgNi/Au 5 µm	AgNi		
Rated operational voltage U _o (VDE 0110, IEC 60947-1)		250 V							
Minimum switching voltage		5 V		10 V (AgNi); 5 V (AgNi/Au)			10 V		
Maximum switching voltage	DC	300 V DC		250 V DC					
	AC	440 V AC		250 V AC			440 V AC		
Minimum switching current		5 mA (AgNi), 2 mA (AgNi/Au)		5 mA (AgNi)	5 mA (AgNi)	2 mA (AgNi/Au)	5 mA		
Rated free air thermal current I _{th}		16 A	8 A	12 A	10 A	6 A	10 A		
Rated operational current (IEC 60947-5-1)	AC-12 (resistive) 230 V	16 A	8 A	12 A	10 A	6 A	10 A		
	AC-15 (inductive) 230 V	1.5 A	1.5 A	1.5 A	1.5 A	1 A	1.5 A		
	AC-15 (inductive) 120 V	3 A				1.5 A	3 A		
	DC-12 (resistive) 24 V	16 A	8 A	12 A	10 A	6 A	10 A		
	DC-13 (inductive) 24 V	2.5 A	2 A	2.5 A	2.5 A	2 A	2 A		
	DC-13 (inductive) 120 V	0.22 A							
	DC-13 (inductive) 250 V	0.1 A							
AC rating (UL 508)	Utilization category (pilot duty) (Contact rating code designation)	B300		B300			B300		
	max. rated operational voltage	300 V AC		300 V AC			300 V AC		
	Max. continuous thermal current at utilization category	5 A		5 A	5 A	2.5 A	5 A		
	Max. making / breaking apparent power at utilization category	3600 / 360 VA		3600 / 360 VA			1800 / 180 VA	3600/360 VA	
	Utilization category (resistive) (CSA22.2 No.14...)	16 A, 250 V AC	8 A, 250 V AC	10 A, 250 V AC 12 A, 150 V AC	6 A, 250 V AC 10 A, 150 V AC	5 A, 250 V AC 10 A, 150 V AC	10 A, 250 V AC (resistive + single-phase)		
DC rating * (UL 508; NEMA ICS-5)	Utilization category (pilot duty) (Contact rating code designation)	R300							
	Max. rated operational voltage	300 V DC							
	Max. continuous thermal current at utilization category	1 A							
	Max. making / breaking apparent power at utilization category	28 VA							
	Utilization category (resistive) (CSA22.2 No.14...)	-	10 A, 24 V DC	-			10 A, 28 V DC		
Maximum making (inrush) current		30 A	15 A	24 A	20 A	12 A	20 A		
Minimum switching power		0.3 W (AgNi), 0.05 W (AgNi/Au)		0.3 W (AgNi), 0.1 W (AgNi/Au)			0.3 W		
Maximum switching (breaking) power	AC1 (resistive)	4000 VA	2000 VA	3000 VA	2500 VA	1500 VA	2500 VA		
Contact resistance		≤ 100 mΩ							
Maximum operating frequency	rated load AC-1	600 switching cycles/h		1200 switching cycles/h					
	without load	72000 switching cycles/h		18000 switching cycles/h			12000 switching cycles/h		
Mechanical lifetime		> 3 x 10 ⁷ switching cycles		> 2 x 10 ⁷ switching cycles					
Electrical lifetime	electrical AC1 (resistive)	> 0.7 x 10 ⁵ switching cycles (16 A, 250 V)	> 10 ⁵ switching cycles (8 A, 250 V)	> 10 ⁵ switching cycles (12 A, 250 V)	> 10 ⁵ switching cycles (10 A, 250 V)	> 10 ⁵ switching cycles (6 A, 250 V)	> 10 ⁵ switching cycles (12 A, 250 V)		
	cos φ	see reduction factor F							
Response time		typ. 7 ms		typ. 13 ms (DC), 10 ms (AC)			typ. 18 ms (DC), 12 ms (AC)		
Release time		typ. 3 ms		typ. 3 ms (DC), 8 ms (AC)			typ. 7 ms (DC), 10 ms (AC)		
Isolation data									
Rated insulation voltage		400 V AC		250 V AC					
Insulation class		C250 / B400		C250 / B250			C250		
Rated impulse withstand voltage U _{imp}	between coil and contacts	5 kV AC		2.5 kV AC					
	between open contacts	1 kV AC		1.5 kV AC					
	between c/o (SPDT) contacts	-	2.5 kV AC	2.5 kV AC		≥ 2 kV AC	2 kV AC		
Clearance between coil and contacts		≥ 10 mm		≥ 2.5 mm			≥ 1.6 mm	≥ 3 mm	
Creepage distance between coil and contacts		≥ 10 mm		≥ 4 mm			≥ 3.2 mm	≥ 4.2 mm	
Overvoltage category		III		III			II	III	
Pollution degree		3		3			2	3	

* Those ratings are based on different type tests but they are not covered by the cULus or CSA approvals.

Pluggable interface relays

Technical data, load limit curves - CR-P, CR-M, CR-U

Type	CR-P...1	CR-P...2	CR-M...2	CR-M...3	CR-M...4	CR-U...2	CR-U...3	
General data								
Dimensions (W x H x D) when mounted	12.7 x 29 x 15.7 mm		21.2 x 27.5 x 35.6 mm			35 x 35 x 54.4 mm		
Weight	14 g (0.031 lb)		35 g (0.077 lb)			83 g (0.18 lb)		
Mounting	on socket (see accessories)							
Mounting position	any							
Degree of protection	IP 67			IP 40				
Electrical connection								
Connection	by socket							
Environmental data								
Ambient temperature range	operation	DC: -40...+85 °C; AC: -40...+70 °C			DC: -40...+70 °C; AC: -40...+55 °C			
	storage	-40 ... +85 °C						
Vibration resistance 10-150 Hz	n/o contact	10 g		5 g		5 g		
	n/c contact	10 g	5 g	5 g	5 g			
Shock resistance	n/o contact	30 g	20 g	10 g	10 g			
	n/c contact	30 g	20 g	5 g	10 g			
Standards								
Product standard	IEC/EN 60255-23, IEC/EN 60664-1, IEC/EN 61810-1			IEC/EN 60255-23, IEC/EN 60810-1, IEC/EN 61810-7			IEC/EN 60255-1	
Low Voltage Directive	2006/95/EC							

Approvals see page 5/6.

Load limit curves - Maximum switching power at resistive DC load

CR-P with 1 c/o contact

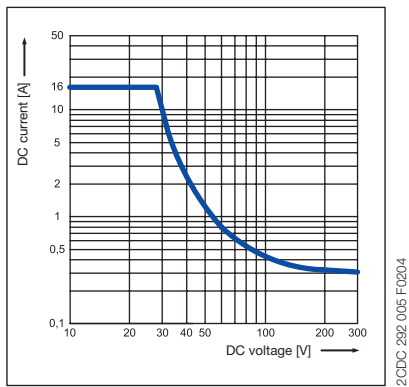

CR-P with 2 c/o contacts

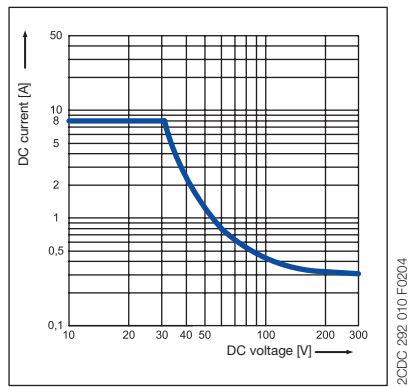

CR-U with 2 and 3 c/o contacts

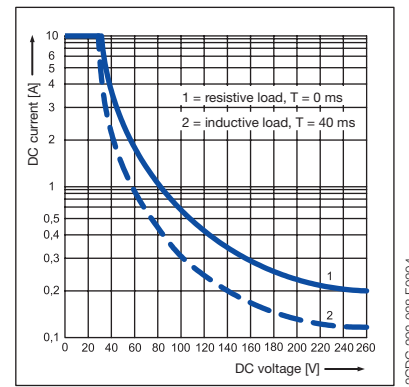

CR-M with 2 c/o contacts

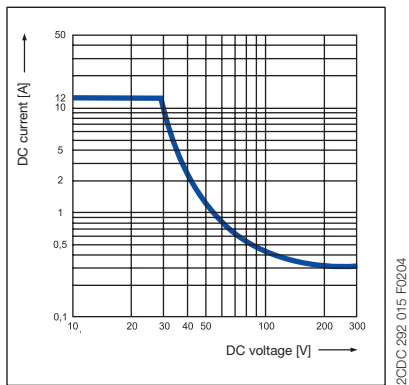

CR-M with 3 c/o contacts

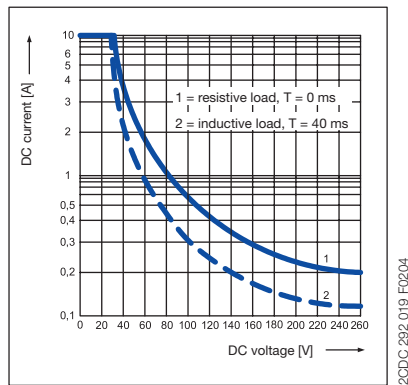

CR-M with 4 c/o contacts

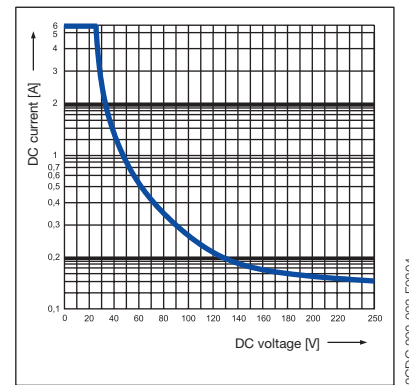

Pluggable interface relays

Technical data - Sockets for CR-P and CR-M

Output circuits		CR-PLS	CR-PLS(x)	CR-PSS	CR-PLC	CR-MxLS	CR-MxSS	CR-MxSF	CR-MxLC	
Output circuits		11-12/14, 21-22/24				11-12/14, 21-22/24, ...				
Number of poles		2				2, 3 or 4		2 or 4		
Rated voltage		250 V AC	300 V AC	250 V AC	250 V AC				300 V AC	
Rated current		2 x 10 A ¹⁾	2 x 12 A ¹⁾	2 x 10 A ¹⁾	7 A				10 A	
General data										
Dimensions without holder and module (L x W x H)		76 x 15.8 x 62 mm (2.992 x 0.622 x 2.441 in)	78.5 x 15.5 x 61 mm (3.011 x 0.610 x 2.402 in)	76 x 15.8 x 42.8 mm (2.992 x 0.622 x 1.685 in)	97.5 x 16.3 x 45.2 mm (3.839 x 0.642 x 1.780 in)	75 x 27.2 x 60.8 mm (2.952 x 1.071 x 2.394 in)	75.2 x 27.2 x 42.6 mm (2.961 x 1.071 x 1.677 in)	66.7 x 30.3 x 29 mm (2.626 x 1.193 x 1.142 in)	95 x 31 x 42.5 mm (3.74 x 1.22 x 1.67 in)	
Degree of protection		IP 20 B (EN 60529)								
Temperature range		operation		operation		operation		operation		
storage		storage		storage		storage		storage		
Terminals		IP 20 B (EN 60529)								
Temperature range		-40...+70 °C	-40...+85 °C	-40...+70 °C	-40...+70 °C	-40...+70 °C	-40...+70 °C	-40...+70 °C	-25...+85 °C	
Connection type		screw connection				spring connection		screw connection		fork type screw
Maximum number of wires per connecting terminal		2				2 (one per connection point)		2		2 (one per connection point)
Wire size		rigid				spring connection		screw connection		fork type screw
fine-strand		2 x 2.5 mm ² (2 x 14 AWG)				0.2-1.5 mm ² (24-16 AWG)		2 x 2.5 mm ² (2 x 14 AWG)		2 x 1.5 mm ² (2 x 16 AWG)
with wire end ferrule		2 x 1.5 mm ² (2 x 16 AWG)				2 x 1.5 mm ² (2 x 16 AWG)		2 x 1.5 mm ² (2 x 16 AWG)		0.2 - 1.5 mm ² (24 x 16 AWG)
Stripping length		-				7 mm (0.28 in)		-		-
Tightening torque		0.6 Nm	0.8 Nm	0.6 Nm	0.6 Nm (5.31 lb.in)		-		-	
Maximum clamping force		with 0.2 mm ²		with 1.5 mm ²		with wire end ferrule		with wire end ferrule		
with wire end ferrule		-		-		-		-		
with 0.2 mm ²		-		-		-		-		
with 1.5 mm ²		-		-		-		-		
with wire end ferrule		-		-		-		-		
Mounting		DIN rail (IEC/EN 60715)								
Material		socket				contacts		terminals		combi screw M3
socket		PA 6+GF - V2				CuZn33		8 μ Ni		8.8 Steel, 5 μ Ni
contacts		5 μ Ni				5 μ tinned		5 μ Ni		-
contact surface		5 μ Ni				5 μ Ni		6 μ Ni		5 μ tinned
terminals		8 μ Ni				8 μ galvanized		8 μ Ni		CCSC
combi screw M3		8.8 Steel, 5 μ Ni				-		8.8 Steel, 5 μ Ni		-
Isolation data										
Insulation voltage		> 5 kV	> 3 kV	> 5 kV	> 3 kV		> 4 kV		-	
Isolation between coil and contacts		EN 61984			VDE 0106 / 101		EN 61984		DIN EN 61140, VDE 0140-1	
Clearance and creepage distance		EN 61984			DIN EN 60664-1		EN 61984		DIN EN 60664-1	
Standards										
Products standard		EN 61984				EN 61984		-		-
Low Voltage Directive		2006/95/EC				2006/95/EC		-		-
EMC Directive		-				2004/108/EC		-		-

¹⁾ Loads >10 A (>12 A for CR-PLSx) require jumpering of terminal 11 with 21, 12 with 22, and 14 with 24

Pluggable interface relays

Technical data - Sockets for CR-U

Output circuits	CR-U2S	CR-U3S	CR-U3E	CR-UxSM
Output circuits	11-12/14, 21-22/24,...			
Number of poles	2	3		2 or 3
Rated voltage	250 V AC		300 V AC	250 V
Rated current	10 A			
General data				
Dimensions without holder and module (L x W x H)	75.3 x 37.3 x 26 mm (2.965 x 1.469 x 1.024 in)	75.3 x 38.1 x 26 mm (2.965 x 1.500 x 1.024 in)	70 x 38 x 26 mm (2.756 x 1.496 x 1.024 in)	61.8 x 38.1 x 26 mm (2.756 x 1.500 x 1.024 in)
Degree of protection	IP 20 B (EN 60529)			
Temperature range				
operation	-40...+70 °C		-40...+85 °C	-40...+70 °C
storage	-40...+70 °C		-40...+85 °C	-40...+70 °C
Wire size				
rigid	2 x 2.5 mm ² (2 x 14 AWG)			
fine-strand	2 x 2.5 mm ² (2 x 14 AWG)			
with wire end ferule	2 x 1.5 mm ² (2 x 16 AWG)			
Tightening torque	0.6 Nm		0.8 Nm	0.6 Nm
Mounting	DIN rail (IEC/EN 60715)			
Material				
socket	PA 6+GF - V2			
contacts	CuZn33			
contact surface	6 μ Ni			3 μ Ni
terminals	8 μ Ni		8 μ galvanized	10 μ Ni
combi screw M3	8.8 Steel, 5μ Ni			Steel, 8 μ Ni
Isolation data				
Insulation voltage	> 2 kV			
Isolation between coil and contacts	EN 61984			
Clearance and creepage distance	EN 61984			
Standards				
Products standard	EN 61984: 2001			
Low Voltage Directive	2006/95/EC			

Pluggable interface relays

Technical data - CR-S range

	Rated control supply voltage U_s	Make voltage (at 23 °C)	Maxium voltage (at 55 °C)	Break voltage	Rated power	Coil resistance (at 23 °C)	Tolerance of coil resistance
CR-S005VDC1R(G)	5 V DC	3.75 V DC	7.5 V DC	0.25 V DC	170 mW	147 Ω	$\pm 10 \%$
CR-S012VDC1R(G)	12 V DC	9 V DC	18 V DC	0.6 V DC	170 mW	848 Ω	$\pm 10 \%$
CR-S024VDC1R(G)	24 V DC	18 V DC	36 V DC	1.2 V DC	170 mW	3390 Ω	$\pm 15 \%$
CR-S048VDC1R(G)	48 V DC	36 V DC	72 V DC	2.4 V DC	210 mW	10600 Ω	$\pm 15 \%$
CR-S060VDC1R(G)	60 V DC	45 V DC	90 V DC	3 V DC	210 mW	16600 Ω	$\pm 15 \%$

Output circuits

Output circuits	11-12/14	
Kind of output	1 c/o (SPDT)	
Contact material	AgSnO ₂ / AgSnO ₂ /Au	
Rated operational voltage U_g (IEC/EN 60947-1)	250 V AC	
Minimum switching voltage	12 V DC	
Maximum switching voltage	400 V AC / 125 V DC	
Minimum switching current	100 mA (AgSnO ₂) / 10 mA (AgSnO ₂ /Au)	
Rated free air thermal current I_{th}	5 A	
Rated operational current (IEC/EN 60947-5-1)	AC12 (resistive)	230 V 6 A
	AC15 (inductive)	230 V 1.5 A
	AC15 (inductive)	120 V 3 A
	DC12 (resistive)	24 V 6 A
	DC13 (inductive)	24 V 1 A
	DC13 (inductive)	120 V 0.22 A
	DC13 (inductive)	250 V 0.11 A
AC rating (UL 508; NEMA ICS-5)	Utilization category (pilot duty)	B300
	(Contact rating code designation)	
DC rating (UL 508; NEMA ICS-5)	Utilization category (pilot duty)	R300
	(Contact rating code designation)	
Maximum making (inrush) current	15 A, 240 V AC	
Minimum switching power	100 mA/12 V (AgSnO ₂) / 50 mW (AgSnO ₂ /Au)	
Maximum switching (breaking) power	AC1 (resistive)	1500 VA, 250 V AC
Contact resistance	100 m Ω (at 1 A/ 6 V DC)	
Maximum operating frequency	rated load AC1	360 switching cycles/h
	without load	18000 switching cycles/h
Mechanical lifetime	1 x 10 ⁷ switching cycles	
Electrical lifetime	AC1 (resistive)	(n/c) 3 x 10 ⁴ switching cycles (at +85 °C)
		(n/o) 1 x 10 ⁴ switching cycles (at +85 °C)
Response time	8 ms	
Release time	4 ms	
Isolation data		
Rated insulation voltage	250 V AC	
Rated impulse withstand voltage U_{imp}	between coil and contacts	4000 V AC 1 min
	between open contacts	1000 V AC 1 min
Clearance	between coil and contacts	5.5 mm (0.217 in)
Creepage distance	between coil and contacts	8 mm (0.315 in)
Overtoltage category	III	
Pollution degree	2	
General data		
Dimensions (W x H x D)	28 x 5 x 15 mm (1.102 x 0.196 x 0.590 in)	
Weight	5 g (0.011 lb)	
Mounting	on socket	
Mounting position	any	
Degree of protection	RT II and RT III	
Electrical connection		
Connection	by socket	
Environmental data		
Ambient temperature range	operation	-40...+85 °C
	storage	0...+40 °C
Vibration resistance (10-150 Hz)	n/o contact	10 Hz to 55 Hz 1mm DA
	n/c contact	10 Hz to 55 Hz 1mm DA
Shock resistance	n/o contact	Functional 49 m/s ² / Destructive 980 m/s ²
	n/c contact	Functional 49 m/s ² / Destructive 980 m/s ²
Standards		
Product standard	IEC 61810-1	
Low Voltage Directive	2006/95/EC	

Pluggable interface relays

Technical data - CR-S range sockets

Input circuits	CR-S 6-24 V	CR-S 12-24 V	CR-S 48-60 V	CR-S 110-125 V	CR-S 220-240 V
Rated control supply voltage U_s	6-24 V DC	2-24 V AC/DC	48-60 V AC/DC	110-125 V AC/DC	220-240 V AC/DC
Rated control supply voltage U_s tolerance	(0.8-1.2) U_n	(0.8-1.1) U_n			
Typical current	11-29 mA	11-16 mA	3.6-4.5 mA	3.6 mA	3.6 mA
Response time	8 ms				
Release time	4 ms				
Status device	green LED				
Protective circuit	yes				
Output circuits					
Output circuits	11-12/14				
Number of poles	1				
Rated voltage	250 V AC				
Rated current	6 A				
General data for CR-S with screw connection terminal					
Dimensions without holder (L x W x H)	88.3 x 6.3 x 70.9 mm (3.476 x 0.248 x 2.789 in)				
Degree of protection (EN 60529)	Degree of protection (EN 60529) IP20 (terminals)				
Temperature range	operation	-40...+70 °C			-40...+55 °C
	storage	0...+40 °C			
Connection type	Screw				
Maximum number of wires per connection terminal	2				
Wire size	rigid	1 x 2.5 mm ² (1 x 14 AWG) ; 2 x 1.5 mm ² (2 x 16 AWG)			
	fine-strand	1 x 2.5 mm ² (1 x 14 AWG); 2 x 1.5 mm ² (2 x 16 AWG)			
	with wire end ferule	1 x 2.5 mm ² (1 x 14 AWG); 2 x 1.0 mm ² (2 x 18 AWG)			
Tightening torque	0.5 Nm (4.426 lb.in)				
Stripping length	7 mm (0.276 in)				
Mounting (IEC/EN 60715)	DIN rail				
Material	socket	PA6 +GF-V2			
	contacts	CuZn36			
	contact surface	3 μ Ni/Sn			
	terminals	CuZn40, 3 μ Ni			
	combi screw M3	Fe			
General data for CR-S with spring connection terminal					
Dimensions without holder (L x W x H)	88.3 x 6.3 x 70.9 mm (3.476 x 0.248 x 2.789 in)				
Degree of protection (EN 60529)	Degree of protection (EN 60529) IP20 (terminals)				
Temperature range	operation	-40...+70 °C			-40...+55 °C
	storage	0...+40 °C			
Connection type	Spring				
Maximum number of wires per connection terminal	1				
Wire size	2.5 mm ² (14 AWG) rigid, fine-strand and with wire end ferule				
Stripping length	7 mm (0.276 in)				
Mounting (IEC/EN 60715)	DIN rail				
Material	socket	PA6 +GF-V2			
	contacts	CuZn36			
	contact surface	3 μ Ni/Sn			
	spring terminals	SUS301			
Isolation data					
Isolation between coil and contacts	5000 V AC				
Resistance to shock coil to contact	1000 MΩ				
Clearance and creepage distance	IEC/EN 61984				
Standards					
Product stancard	IEC/EN 61984: 2001				
Low Voltage Directive	2006/95/EC				

Load limit curves - Max. DC load breaking capacity

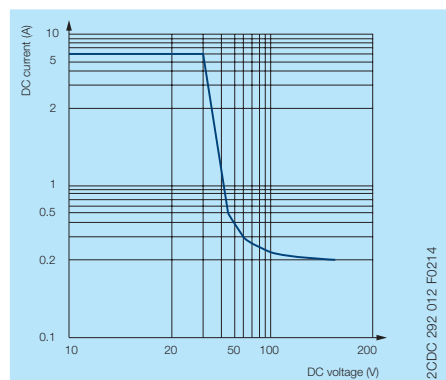

Endurance curve

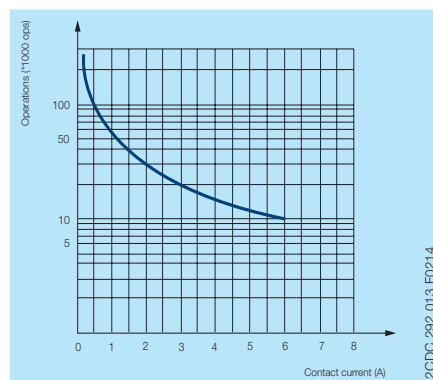

Pluggable interface relays

Load limit curves

Load limit curves - Electrical lifetime at resistive AC load

5

CR-P with 1 c/o contact

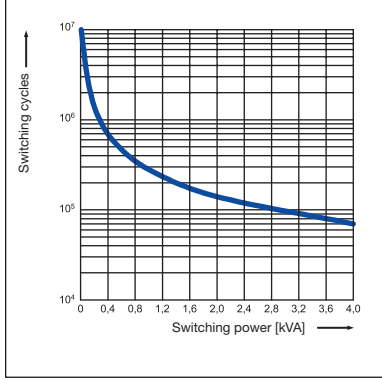

CR-P with 2 c/o contacts

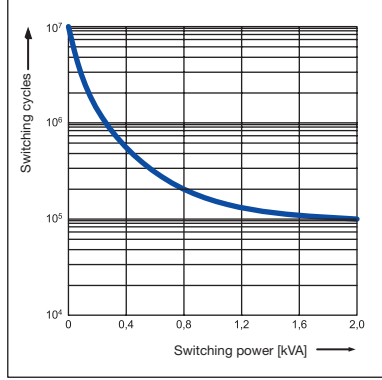

CR-U with 2 and 3 c/o contacts

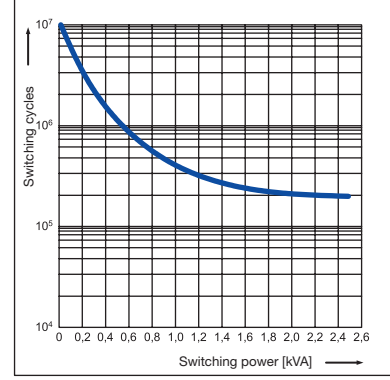

CR-M with 2 c/o contacts

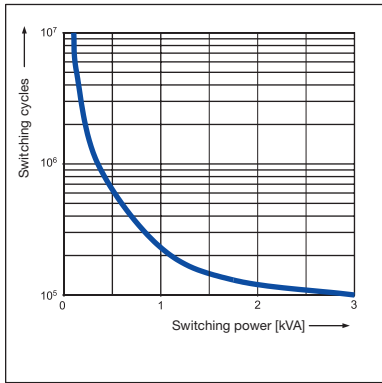

CR-M with 3 c/o contacts

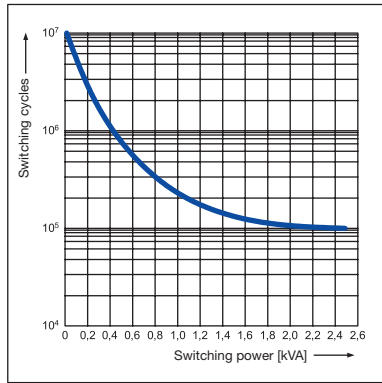

CR-M with 4 c/o contacts

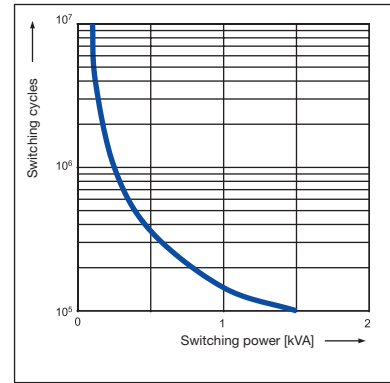

Reduction factor F at inductive AC load

CR-P

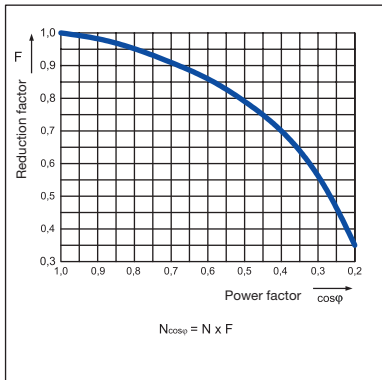

CR-M

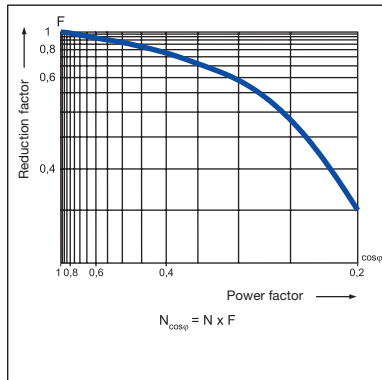

CR-U

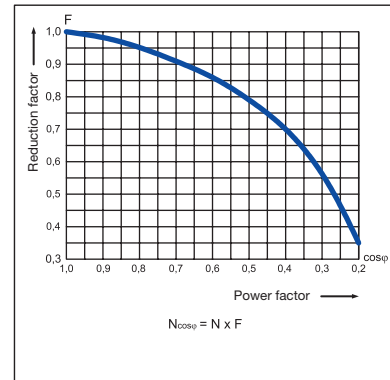

Pluggable interface relays

Connection diagrams, Dimensional drawings

Connection diagrams

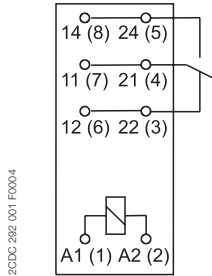

CR-P with 1 c/o contact

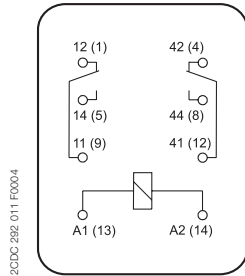

CR-M with 2 c/o contacts

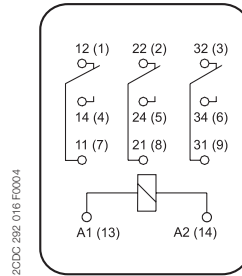

CR-M with 3 c/o contacts

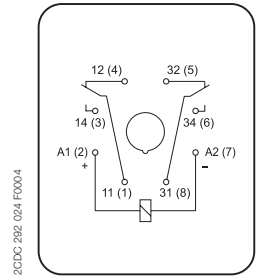

CR-U with 2 c/o contacts

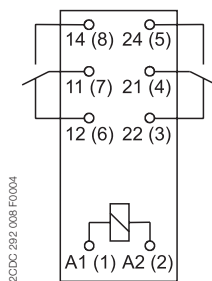

CR-P with 2 c/o contacts

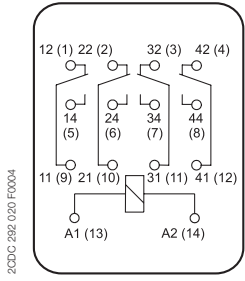

CR-M with 4 c/o contacts

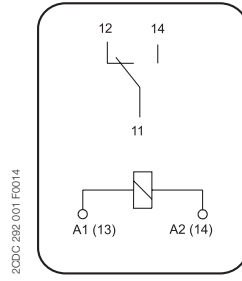

CR-S

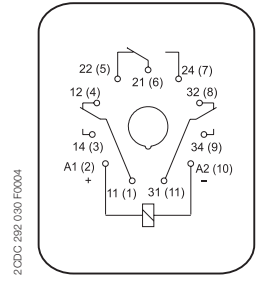

CR-U with 3 c/o contacts

Dimensional drawings Dimensions in mm and inches

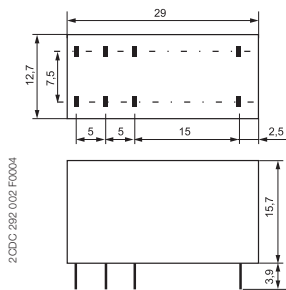

CR-P

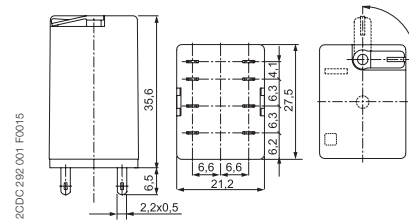

CR-M with 2 c/o contacts

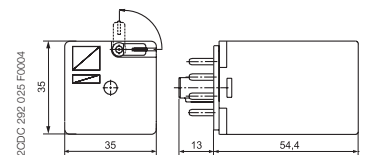

CR-U with 2 c/o contacts

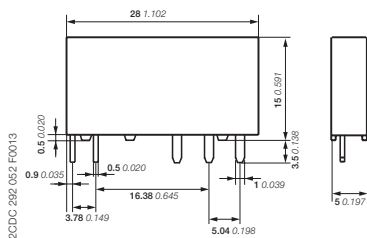

CR-S

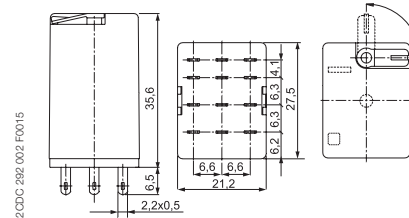

CR-M with 3 c/o contacts

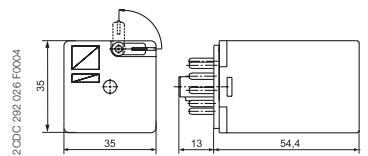

CR-U with 3 c/o contacts

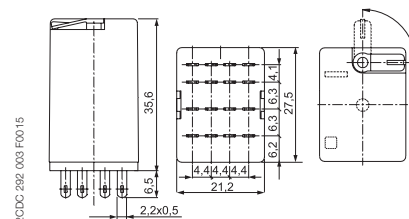

CR-M with 4 c/o contacts

Pluggable interface relays

Dimensional drawings

Dimensions in mm and inches

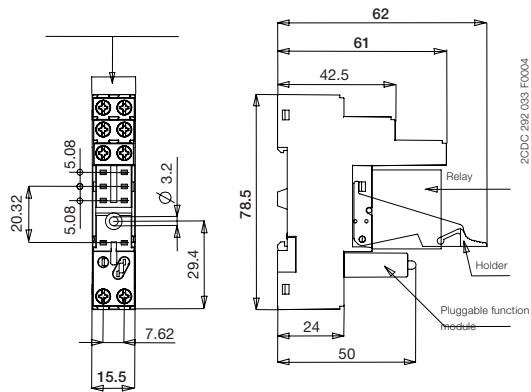
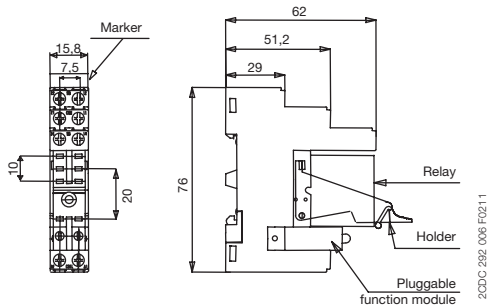

CR-PLS - screw connection

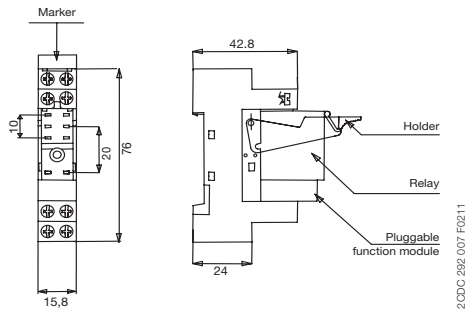

CR-PLSx - screw connection

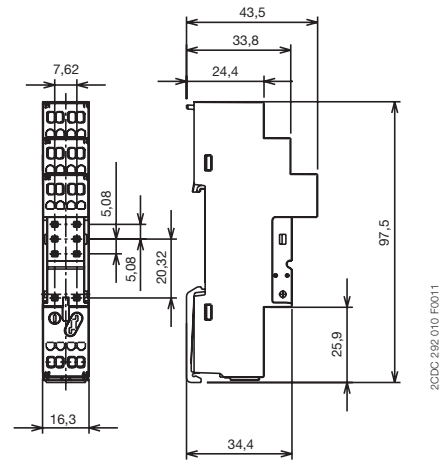

CR-PSS - screw connection

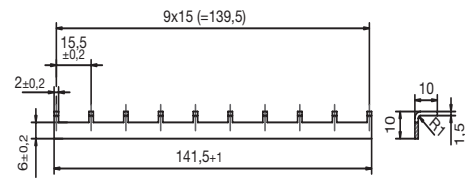

CR-PLC - spring connection

CR-PJ

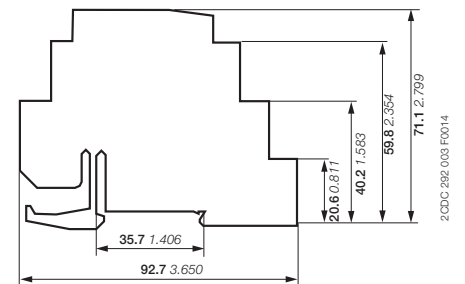
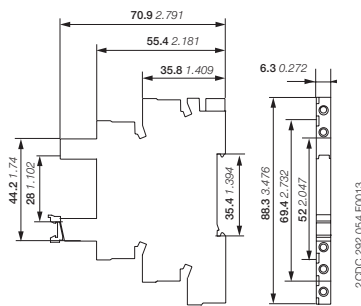
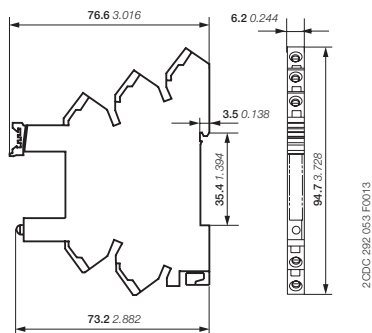

Spring socket for CR-S range interface relays

Screw socket for CR-S range interface relays

Separator for CR-S

Jumper

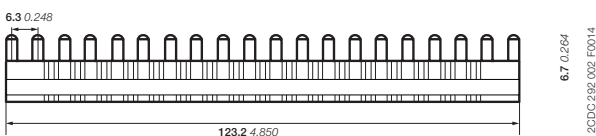

Jumper bar CR-S

Pluggable interface relays

Dimensional drawings

Dimensions in mm and inches

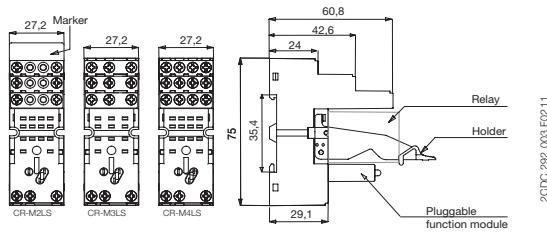

2CDC 292 003 F0211

CR-M2LS - CR-M3LS - CR-M4LS - screw connection

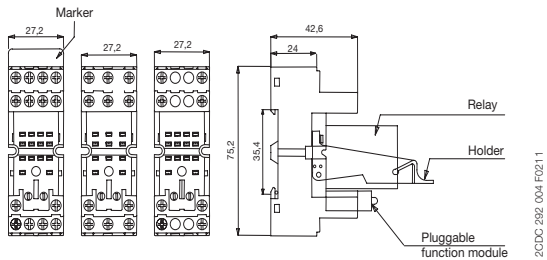

2CDC 292 004 F0211

CR-M2SS - CR-M3SS - CR-M4SS - screw connection

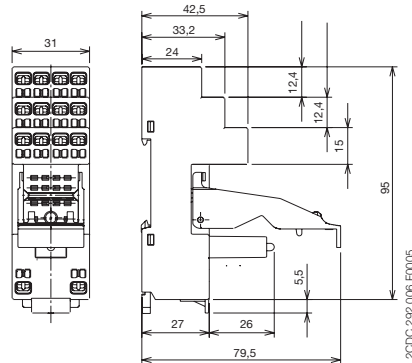

2CDC 292 006 F0005

CR-M2LC, CR-M4LC - spring connection

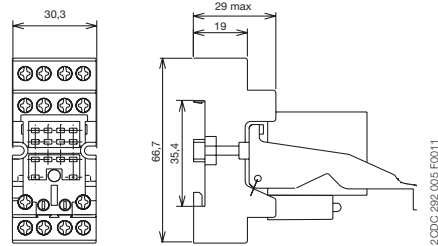

2CDC 292 005 F0011

CR-MxSF - screw connection

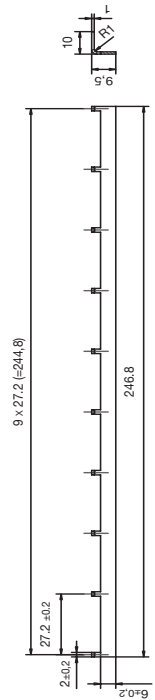

CR-MJ

2CDC 292 011 F0011

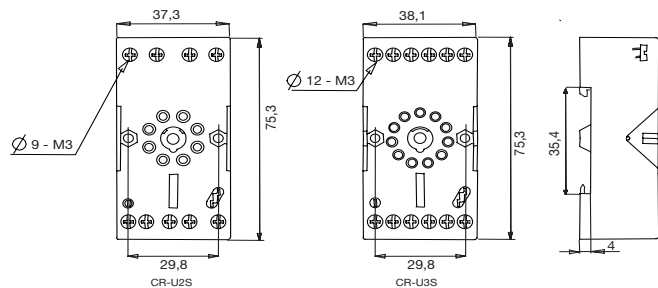

2CDC 292 008 F0011

CR-U2S - CR-U3S

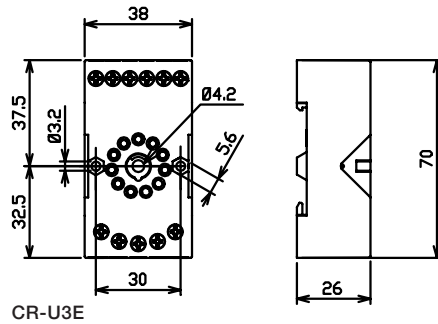

2CDC 292 081 F0004

CR-U3E

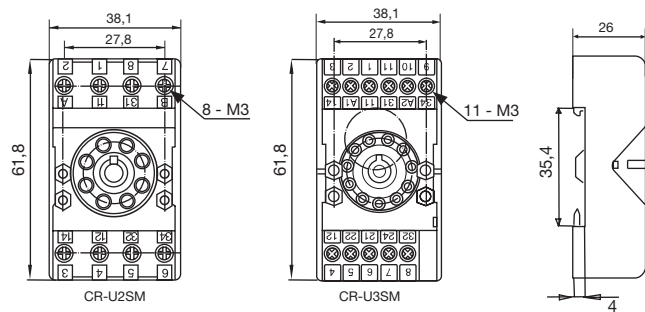

2CDC 292 009 F0011

CR-UxSM

Boxed interface relays and optocouplers R600 range

Product group picture

5



Boxed interface relays and optocouplers R600 range

Table of contents

Boxed interface relays and optocouplers R600 range

Boxed interface relays and optocouplers R600 range	306
Table of contents	306
Overview	307
Benefits and advantages	308
Boxed interface relays R600 range	309
Selection	309
Ordering details	311
Connection diagrams	313
Technical data	314
Dimensional drawings, Load limit curves	317
Boxed interface optocouplers R600 range	319
Selection	319
Ordering details	320
Connection diagrams, Dimensional drawings, Load limit curves	321
Technical data	322
Technical data, Dimensions	324

Boxed interface relays and optocouplers R600 range

Overview

ABB's R600 range of boxed interface relays and optocouplers are used for electrical isolation, amplification and signal matching between the control unit and the sensor/actuator level. The space saving design and different connection terminal possibilities optimize your panel installation.

The broad portfolio of R600 range offers the most suitable interface solution for your application.

5

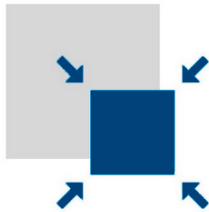

Space saving

Thanks to the 6 mm slim and 70 mm short housing, you maximize the foot print of your panel. The 75 mm depth allows you use in a compact cabinet.

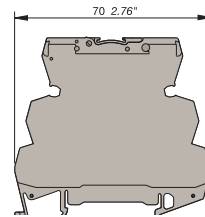

Screw clamp module

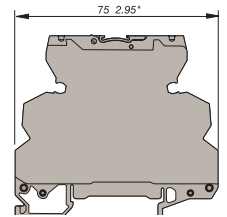

Spring clamp module



Easy to install

The R600 interface relays and optocouplers are easy to mount by snapping onto a DIN-rail which is according to IEC/EN 60715. Time saving wiring thanks to jumper bar.



Global availability

Applicable all over the world according to the highest standards. You will find R600 boxed interface relays and optocouplers in any application and every corner of the world.



Boxed interface relays and optocouplers R600 range

Benefits and advantages

Marine certification

R600 Range offers the LR approval, which allows usage of the boxed interface relays and optocouplers in many applications around the marine segment. The performance of the R600 Range has proven by successfully passing tests required harshest conditions.

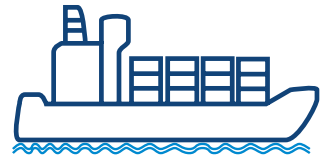

5

Complete product line

1 n/o, 1 n/c, 1 c/o, 2 c/o output configuration. Standard contact material for switching high current signals as well as gold-plated contacts for reliable switching of low current signals.

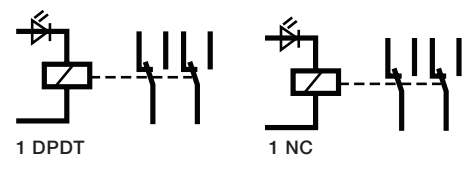
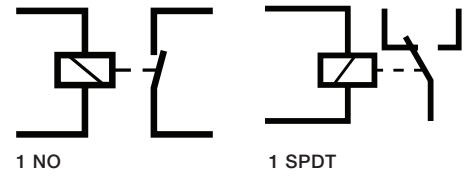

Optocoupler with transistor, MOS-FET and triac output for longer life-time, higher reliability and quiet operation.

Screw and spring connection terminals.

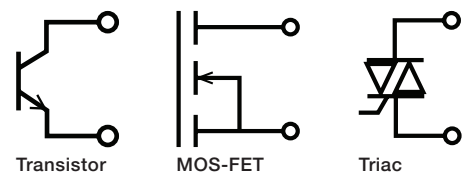

Safe operation

High resistance to vibration and shock thanks to the relay soldered inside of the housing.

Wrong relay replacement or relay lose not possible .

Devices with immunity to the leakage currents.

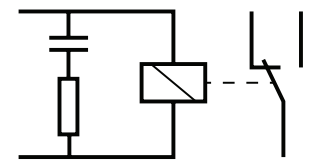

Leakage current protection

Clear functioning status

Green LED for the status of the supply control voltage applied.



Boxed interface relays R600 range

Selection

Type	Order number																							
	RB12IP-5VDC	RB12IPG-5VDC	RBR12IP-5VDC	RB121-12VDC	RB12IP-12VDC	RB12IG-12VDC	RBR12IP-12VDC	RB101R-24VUC	RBR101R-24VUC	RB111-24VUC	RB111R-24VUC	RBR111R-24VUC	RBR111-24VUC	RB121-24VUC	RB12IG-24VUC	RBR12IG-24VUC	RB121G-24VUC	RBR121G-24VUC	RB121-48-60VUC	RB12IG-48-60VUC	RBR121G-48-60VUC	RBR12IG-48-60VUC		
	1SNA645034R2300	1SNA645036R2500	1SNA645534R2500	1SNA645073R0000	1SNA645038R2400	1SNA645075R0000	1SNA645535R2600	1SNA645019R0400	1SNA645519R0600	1SNA645014R2700	1SNA645018R0300	1SNA645518R0500	1SNA645514R2100	1SNA645001R0300	1SNA645005R0700	1SNA645501R0500	1SNA645505R0100	1SNA645012R2500	1SNA645512R2700	1SNA645071R0000	1SNA645571R0000	1SNA645072R0000	1SNA645572R0000	
Input voltage																								
5 V DC	■	■	■																					
12 V DC				■	■	■	■																	
24 V DC								■	■	■	■	■	■	■	■	■	■	■						
48-60 V DC																			■	■	■	■		
115 V DC																								
230 V DC																								
60-230 V DC																								
24 V AC								■	■	■	■	■	■	■	■	■	■	■						
48-60 V AC																			■	■	■	■		
115 V AC																								
230 V AC																								
60-230 V AC																								
Output rating																								
10 mA - 6 A	■	■	■	■	■	■	■	■	■	■	■	■	■	■	■	■	■			■	■	■	■	■
3 mA - 6 A		■				■														■	■		■	■
1 mA - 8 A																		■	■					
Output contacts																								
c/o	1	1	1	1	1	1	1							1	1	1	1	2	2	1	1	1	1	1
n/o									1	1	1	1												
n/c								1	1															
Terminal type																								
Screw	■	■	■	■	■	■	■	■	■	■	■	■	■	■	■	■	■	■			■	■	■	■
Spring			■				■		■		■	■			■	■		■			■	■		■

Boxed interface relays R600 range

Ordering details



R600 - 6 mm

2CDC 291 024 S0013



R600 - 12 mm

2CDC 291 013 S0013

1 n/c contact: 250 V, 10 mA - 6 A, width 12 mm

Rated control supply voltage	Connection type	Particularities	Type	Order code	Pkg qty	Weight (1 pc) kg (lb)
24 V AC/DC	Screw	RC circuit parallel to output contact	RB101R-24VUC	1SNA645019R0400	5	0.04 (0.088)
	Spring		RBR101R-24VUC	1SNA645519R0600		

1 n/o contact: 250 V, 10 mA - 6 A, width 6 mm

Rated control supply voltage	Connection type	Particularities	Type	Order code	Pkg qty	Weight (1 pc) kg (lb)
24 V AC/DC	Screw		RB111-24VUC	1SNA645014R2700	10	0.02 (0.044)
115 V AC/DC	Screw		RB111-115VUC	1SNA645016R2100		
230 V AC/DC	Screw		RB111-230VUC	1SNA645017R2200		
24 V AC/DC	Spring		RBR111-24VUC	1SNA645514R2100		

1 n/o contact: 250 V, 10 mA - 6 A, width 12 mm

Rated control supply voltage	Connection type	Particularities	Type	Order code	Pkg qty	Weight (1 pc) kg (lb)
24 V AC/DC	Screw	RC circuit parallel to output contact	RB111R-24VUC	1SNA645018R0300	5	0.04 (0.088)
	Spring		RBR111R-24VUC	1SNA645518R0500		

1 c/o (SPDT) contact: 250 V, 10 mA - 6 A, width 6 mm

Rated control supply voltage	Connection type	Particularities	Type	Order code	Pkg qty	Weight (1 pc) kg (lb)
5 V DC	Screw	A1-A2 polarized	RB121P-5VDC	1SNA645034R2300	10	0.02 (0.044)
12 V DC	Screw	A1-A2 polarized	RB121P-12VDC	1SNA645035R2400		
12 V DC	Screw		RB121-12VDC	1SNA645073R0000		
24 V DC	Screw		RB121-24VDC	1SNA645071R0000		
24 V AC/DC	Screw		RB121-24VUC	1SNA645001R0300		
48-60 V AC/DC	Screw		RB121-48-60VUC	1SNA645002R0400		
115 V AC/DC	Screw		RB121-115VUC	1SNA645003R0500		
230 V AC/DC	Screw		RB121-230VUC	1SNA645004R0400		
5 V DC	Spring	A1-A2 polarized	RBR121P-5VDC	1SNA645534R2500		
12 V DC	Spring	A1-A2 polarized	RBR121P-12VDC	1SNA645535R2600		
24 V DC	Spring		RBR121-24VDC	1SNA645571R0000		
24 V AC/DC	Spring		RBR121-24VUC	1SNA645501R0500		
48-60 V AC/DC	Spring		RBR121-48-60VUC	1SNA645502R0600		
115 V AC/DC	Spring		RBR121-115VUC	1SNA645503R0700		
230 V AC/DC	Spring		RBR121-230VUC	1SNA645504R0000		

1 c/o (SPDT) contact: 250 V, 3 mA - 6 A, gold-plated contacts, width 6 mm

Rated control supply voltage	Connection type	Particularities	Type	Order code	Pkg qty	Weight (1 pc) kg (lb)
5 V DC	Screw	A1-A2 polarized	RB121PG-5VDC	1SNA645036R2500	10	0.02 (0.044)
12 V DC	Screw		RB121G-12VDC	1SNA645075R0000		
24 V DC	Screw		RB121G-24VDC	1SNA645072R0000		
24 V AC/DC	Screw		RB121G-24VUC	1SNA645005R0700		
48-60 V AC/DC	Screw		RB121G-48-60VUC	1SNA645006R0000		
115 V AC/DC	Screw		RB121G-115VUC	1SNA645007R0100		
230 V AC/DC	Screw		RB121G-230VUC	1SNA645008R1200		
24 V DC	Spring		RBR121G-24VDC	1SNA645572R0000		
24 V AC/DC	Spring		RBR121G-24VUC	1SNA645505R0100		
48-60 V AC/DC	Spring		RBR121G-48-60VUC	1SNA645506R0200		
115 V AC/DC	Spring		RBR121G-115VUC	1SNA645507R0300		
230 V AC/DC	Spring		RBR121G-230VUC	1SNA645508R1400		



Further documentation
R600 range on www.abb.com

Boxed interface relays R600 range

Ordering details

1 c/o (SPDT) contact: 250 V, 10 mA - 6 A, width 12 mm

Rated control supply voltage	Connection type	Particularities	Type	Order code	Pkg qty	Weight (1 pc) kg (lb)
60-230 V AC/DC	Screw		RB121-60-230VUC	1SNA645020R0100	5	0.04 (0.088)
115 V AC/DC	Screw	Leakage current protection, RC circuit parallel to input	RB121R-115VUC	1SNA645046R0700		
230 V AC/DC	Screw		RB121R-230VUC	1SNA645011R2400		
60-230 V AC/DC	Spring		RBR121-60-230VUC	1SNA645520R0300		
230 V AC/DC	Spring	Leakage current protection, RC circuit parallel to input	RBR121R-230VUC	1SNA645511R2600		

2 c/o (SPDT) contacts: 250 V, 1 mA - 8 A, gold-plated contacts, width 12 mm

Rated control supply voltage	Connection type	Type	Order code	Pkg qty	Weight (1 pc) kg (lb)
24 V AC/DC	Screw	RB122G-24VUC	1SNA645012R2500	5	0.04 (0.088)
48-60 V AC/DC	Screw	RB122G-48-60VUC	1SNA645040R1500		
115 V AC/DC	Screw	RB122G-115VUC	1SNA645041R0200		
230 V AC/DC	Screw	RB122G-230VUC	1SNA645013R2600		
24 V AC/DC	Spring	RBR122G-24VUC	1SNA645512R2700		
48-60 V AC/DC	Spring	RBR122G-48-60VUC	1SNA645540R1700		
115 V AC/DC	Spring	RBR122G-115VUC	1SNA645541R0400		
230 V AC/DC	Spring	RBR122G-230VUC	1SNA645513R2000		

Ordering details - Accessories

Description	Type	Order code	Pkg qty	Weight (1 pc) kg (lb)
Jumper bar, 10 poles	BJ612-10	1SNA290488R0100	10	0.05 (0.11)
Jumper bar, 20 poles	BJ612-20	1SNA206754R0000		0.01 (0.022)
Separator end section	SC612	1SNA290474R0200		0.05 (0.11)
Front marking blank cards, 100 pcs.	RC610	1SNA233000R0100		
Terminal marking blank cards, 100 pcs.	RC65	1SNA232000R0000		

Boxed interface relays R600 range

Connection diagrams

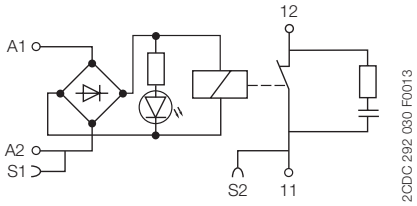

RB(R)101R - 24VUC

2CDC 292 030 F0013

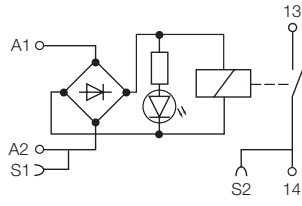

RB(R)111-24VUC

2CDC 292 031 F0013

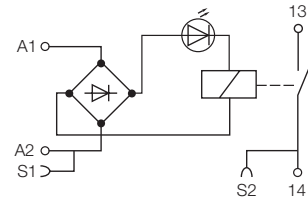

RB111-115VUC/230VUC

2CDC 292 033 F0013

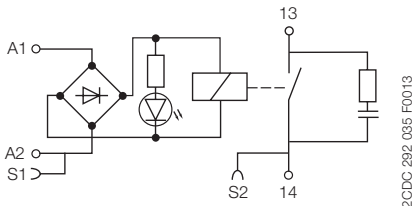

RB(R)111R-24VUC

2CDC 292 035 F0013

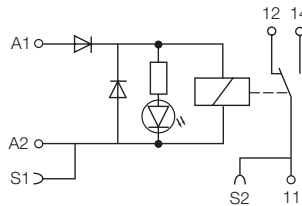

RB(R)121P(G)-5VDC/12VDC

2CDC 292 036 F0013

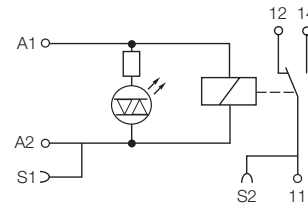

RB(R)121-12VDC/24VDC

2CDC 292 038 F0013

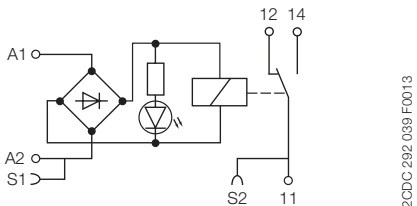

RB(R)121(G)-24VUC

2CDC 292 039 F0013

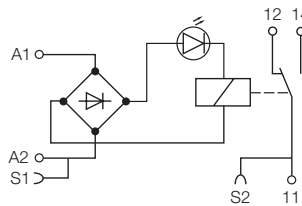

**RB(R)121(G)-48-60VUC/
115VUC/230VUC/60-230VUC**

2CDC 292 040 F0013

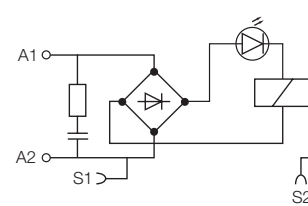

RB(R)121R-115VUC/230VUC

2CDC 292 042 F0013

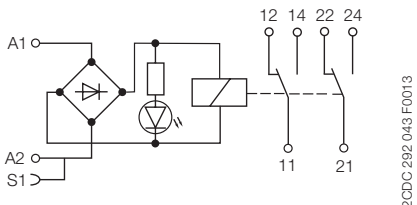

RB(R)122G-24VUC/48-60VUC

2CDC 292 043 F0013

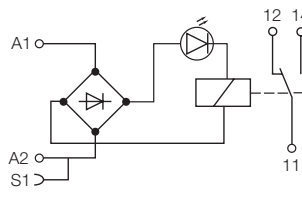

RB(R)122G-115VUC/230VUC

2CDC 292 044 F0013

Boxed interface relays R600 range

Technical data

	RB(R)101R-		RB(R)111R-
	24VUC	24VUC	24VUC
Input circuit			
Rated control supply voltage U_s	24 V AC/DC		
Rated control supply voltage U_s tolerance	DC	-15 %, +20 %	
	AC	-/+ 10 %	
Rated frequency	50/60 Hz		
Typical power consumption	0.24 W		
Typical current	10 mA		
Drop-out voltage	at 20 °C 4.5 V		
Indication of operational states	green LED	┐ ┌: control supply voltage applied	
Output circuit			
Kind of output	11-12	relay, 1 n/c contact	-
	13-14	-	relay, 1 n/o contact
Rated operational voltage U_o (IEC/EN 60947-1)	250 V AC		
Minimum switching voltage	12 V		
Maximum switching voltage	250 V AC		
Minimum switching current	10 mA		
Rated free air thermal current I_{th}	6 A		
Rated operational current I_o (IEC/EN 60947-5-1)	AC-12 (resistive) 230 V	6 A	
	AC-15 (inductive) 230 V	1.5 A	
	AC-15 (inductive) 120 V	3 A	
	DC-12 (resistive) 24 V	6 A	
	DC-13 (inductive) 24 V	1 A	
	DC-13 (inductive) 110 V	0.2 A	
	DC-13 (inductive) 220 V	0.1 A	
AC rating (UL 508; NEMA ICS-5)	Utilization category (pilot duty)	B300	
DC rating (UL 508; NEMA ICS-5)	Utilization category (pilot duty)	R300	
Minimum switching power	0.6 W / 0.6 VA		
Mechanical lifetime	1 x 10 ⁷ switching cycles		
Electrical lifetime	at AC-15 1 x 10 ⁵ switching cycles		
Max. fuse rating to achieve short-circuit protection	6 A fast		
Response time	5 ms		
Release time	8 ms		

	RB(R)111-		
	24VUC	115VUC	230VUC
Input circuit			
Rated control supply voltage U_s	24 V AC/DC	115 V AC/DC	230 V AC/DC
Rated control supply voltage U_s tolerance	DC -15 %, +20 %	-15 %, +10 %	
	AC -/+ 10 %		
Rated frequency	50/60 Hz		
Typical power consumption	0.24 W	0.46 W	0.8 W
Typical current	10 mA	4 mA	3.5 mA
Drop-out voltage	at 20 °C 4.5 V	17 V	27 V
Indication of operational states	green LED	┐ ┌: control supply voltage applied	
Output circuit			
Kind of output	13-14	relay, 1 n/o contact	
Rated operational voltage U_o (IEC/EN 60947-1)	250 V AC		
Minimum switching voltage	12 V		
Maximum switching voltage	250 V AC		
Minimum switching current	10 mA		
Rated free air thermal current I_{th}	6 A		
Rated operational current I_o (IEC/EN 60947-5-1)	AC-12 (resistive) 230 V	6 A	
	AC-15 (inductive) 230 V	1.5 A	
	AC-15 (inductive) 120 V	3 A	
	DC-12 (resistive) 24 V	6 A	
	DC-13 (inductive) 24 V	1 A	
	DC-13 (inductive) 110 V	0.2 A	
	DC-13 (inductive) 220 V	0.1 A	
AC rating (UL 508; NEMA ICS-5)	Utilization category (pilot duty)	B300	
DC rating (UL 508; NEMA ICS-5)	Utilization category (pilot duty)	R300	
Minimum switching power	0.6 W / 0.6 VA		
Mechanical lifetime	1 x 10 ⁷ switching cycles		
Electrical lifetime	at AC-15 1 x 10 ⁵ switching cycles		
Max. fuse rating to achieve short-circuit protection	6 A fast		
Response time	5 ms	6 ms	7 ms
Release time	8 ms	15 ms	15 ms

Boxed interface relays R600 range

Technical data

		RB(R)121(P)(G)-							
		5VDC	12VDC	24VDC	24VUC	48-60VUC	115VUC	230VUC	
Input circuit									
Rated control supply voltage U_s		5 V DC	12 V DC	24 V DC	24 V AC/DC	48 V AC/DC	60 V AC/DC	115 V AC/DC	230 V AC/DC
Rated control supply voltage U_s	DC	-15 %, +20 %							
tolerance	AC	-		-/+ 10 %					
Rated frequency				50/60 Hz					
Typical power consumption		0.2 W	0.2 W	0.24 W		0.33 W	0.54 W	0.46 W	0.8 W
Typical current		40 mA	16 mA	10 mA		7 mA	9 mA	4 mA	3.5 mA
Drop-out voltage	at 20 °C	1.2 V	2.2 V	4.5 V		8 V	8 V	17 V	27 V
Indication of operational states	green LED	 l: control supply voltage applied							
Output circuit									
Kind of output	11-12/14	relay, 1 c/o (SPDT) contact							
Rated operational voltage U_o (IEC/EN 60947-1)		250 V AC							
Minimum switching voltage		12 V / gold-plated contacts: 5 V							
Maximum switching voltage		250 V AC							
Minimum switching current		10 mA / gold-plated contacts: 3 mA at 20 V							
Rated free air thermal current I_{th}		6 A							
Rated operational current I_e (IEC/EN 60947-5-1)	AC-12 (resistive) 230 V	6 A							
	AC-15 (inductive) 230 V	1.5 A							
	AC-15 (inductive) 120 V	3 A							
	DC-12 (resistive) 24 V	6 A							
	DC-13 (inductive) 24 V	1 A							
	DC-13 (inductive) 110 V	0.2 A							
	DC-13 (inductive) 220 V	0.1 A							
AC rating (UL 508; NEMA ICS-5)	Utilization category (pilot duty)	B300							
DC rating (UL 508; NEMA ICS-5)	Utilization category (pilot duty)	R300							
Minimum switching power		0.6 W / 0.6 VA; gold plated contacts: 0.06 V / 0.06 VA							
Mechanical lifetime		1 x 10 ⁷ switching cycles							
Electrical lifetime	at AC-15	1 x 10 ⁵ switching cycles							
Max. fuse rating to achieve short-circuit protection		6 A fast							
Response time		5 ms	5 ms	5 ms		5 ms	5 ms	6 ms	7 ms
Release time		8 ms	8 ms	8 ms		8 ms	8 ms	15 ms	16 ms

		RB(R)121R-				115VUC				230VUC			
Input circuit													
Rated control supply voltage U_s		115 V AC/DC				230 V AC/DC							
Rated control supply voltage U_s	DC	-20%, +15%				-10%, +15%							
tolerance	AC	-/+ 10 %											
Rated frequency		50/60 Hz											
Typical power consumption		2 W				2.8 W							
Typical current		18 mA				12 mA							
Drop-out voltage	at 20 °C	17 V				27 V							
Indication of operational states	green LED	 l: control supply voltage applied											
Output circuit													
Kind of output	11-12/14	relay, 1 c/o (SPDT) contact											
Rated operational voltage U_o (IEC/EN 60947-1)		250 V AC											
Minimum switching voltage		12 V											
Maximum switching voltage		250 V AC											
Minimum switching current		10 mA											
Rated free air thermal current I_{th}		6 A											
Rated operational current I_e (IEC/EN 60947-5-1)	AC-12 (resistive) 230 V	6 A											
	AC-15 (inductive) 230 V	1.5 A											
	AC-15 (inductive) 120 V	3 A											
	DC-12 (resistive) 24 V	6 A											
	DC-13 (inductive) 24 V	1 A											
	DC-13 (inductive) 110 V	0.2 A											
	DC-13 (inductive) 220 V	0.1 A											
AC rating (UL 508; NEMA ICS-5)	Utilization category (pilot duty)	B300											
DC rating (UL 508; NEMA ICS-5)	Utilization category (pilot duty)	R300											
Minimum switching power		0.6 W / 0.6 VA											
Mechanical lifetime		1 x 10 ⁷ switching cycles											
Electrical lifetime	at AC-15	1 x 10 ⁵ switching cycles											
Max. fuse rating to achieve short-circuit protection		6 A fast											
Response time		6 ms								7 ms			
Release time		15 ms								16 ms			

Boxed interface relays R600 range

Technical data

	RB(R)122G				
	24 V UC	48-60 V UC	60 V AC/DC	115 V UC	230 V UC
Input circuit					
Rated control supply voltage U_s	24 V AC/DC	48 V AC/DC	60 V AC/DC	115 V AC/DC	230 V AC/DC
Rated control supply voltage U_s tolerance	DC -15 %, +20 % AC +/- 10 %				-15 %, +10 %
Rated frequency	50/60 Hz				
Typical power consumption	0.48 W	0.62 W	0.96 W	0.58 W	1.15 W
Typical current	20 mA	13 mA	16 mA	5 mA	5 mA
Drop-out at 20 °C	5.4 V	8.8 V	8.8 V V	20 V	10 V
Indication of operational states	green LED	L: control supply voltage applied			
Output circuit					
Kind of output	11-12/14 21-22/24	relay, 1st c/o (SPDT) contact relay, 2nd c/o (SPDT) contact			
Rated operational voltage U_b (IEC/EN 60947-1)	250 V AC				
Minimum switching voltage	5 V				
Maximum switching voltage	250 V DC - 250 V AC				
Minimum switching current	1 mA				
Rated free air thermal current I_{th}	8 A				
Rated operational current I_b (IEC/EN 60947-5-1)	AC-12 (resistive) 230 V	8 A			
	AC-15 (inductive) 230 V	1.5 A			
	DC-12 (resistive) 24 V	8 A			
	DC-13 (inductive) 24 V	1 A			
	DC-13 (inductive) 110 V	0.2 A			
	DC-13 (inductive) 220 V	0.1 A			
Minimum switching power	5 mW / 5 mVA				
Mechanical lifetime	2 x 10 ⁷ switching cycles				
Electrical lifetime at AC-15	1 x 10 ⁵ switching cycles				
Max. fuse rating to achieve short-circuit protection	10 A fast				
Response time	6 ms	10 ms	10 ms	6 ms	6 ms
Release time	10 ms	14 ms	14 ms	15 ms	15 ms

General technical data - Interface relays

		RB	RBR
General data			
Material of housing		UL 94 V0	
Mounting		DIN Rail	
Degree of protection	housing / terminals	IP20 NEMA1	
Electrical connection			
Wire size	fine-strand	0.22-2.5 mm ² (24-14 AWG)	
	rigid	0.2-4 mm ² (24-12 AWG)	0.2-2.5 mm ² (24-14 AWG)
Stripping length		9 mm (0.354 in)	
Tightening torque		0.4-0.6 Nm (3.5-5.3 lb.in)	
		n/a	
Environmental data			
Ambient temperature ranges	storage	-40...+80 °C (-40...+176 °F)	
	operation	-20...+70 °C (-4...+158 °F) ¹⁾	
Isolation data			
Rated insulation voltage U_i		250 V	
Rated impulse withstand voltage U_{imp}	input / output	4 kV	
	shock coil / output	4 kV	
	output / output	1 kV	
Overvoltage category		III	
Pollution degree		2	
Standards			
Product standards		EN 60947-5-1	
Low Voltage Directive		2014/35/EC	
RoHS Directive		2011/65/EC	

¹⁾ Over 55 °C, blocks have to be mounted on horizontal rail with 10 mm spacing between each block. For vertical rail mounting use temperature is 15 °C less decreased.

Boxed interface relays R600 range

Dimensional drawings, Load limit curves

Load limit curves

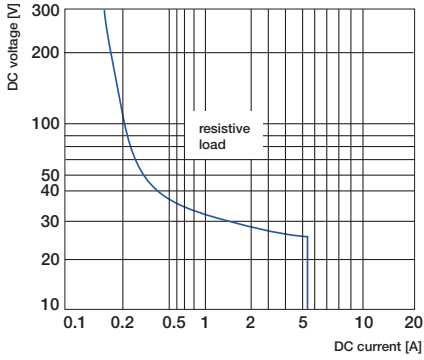

2CDC 292 022 F0212

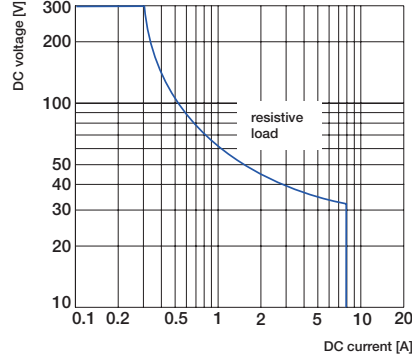

2CDC 292 028 F0213

5

Versions with 1 n/o, 1 n/c or 1 c/o contact

Versions with 2 c/o contacts

	DC-12	AC-12	DC-13	AC-15
24 V	6 A	6 A	1	3 A
110/120 V	0.3 A	6 A	0.2 A	3 A
220/230 V	0.2 A	6 A	0.1 A	3 A

Dimensions

in mm and inches

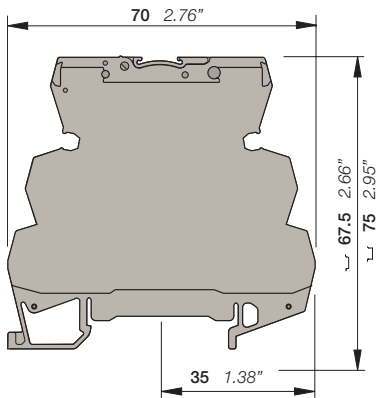

2CDC 292 025 F0013

Versions with screw terminals

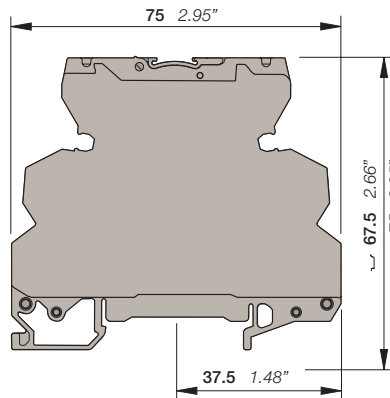

2CDC 292 026 F0013

Versions with spring-type terminals

Boxed interface relays R600 range

Notes

Boxed interface optocouplers R600 range

Ordering details



R600 - 6 mm

2CDC 281 024 50013

Transistor output, 58 V DC, 100 mA, width 6 mm

Rated control supply voltage	Connection type	Type	Order code	Pkg qty	Weight (1 pc) kg (lb)
5 - 12 V DC	Screw	OBIC0100-5-12VDC	1SNA645047R0000	10	0.02 (0.044)
24 V DC	Screw	OBIC0100-24VDC	1SNA645021R2600		
48 - 60 V AC/DC	Screw	OBIC0100-48-60VUC	1SNA645049R1200		
115 - 230 V AC/DC	Screw	OBIC0100-115-230	1SNA645022R2700	10	0.02 (0.044)
5 - 12 V DC	Spring	OBRIC0100-5-12VDC	1SNA645547R0200		
24 V DC	Spring	OBRIC0100-24VDC	1SNA645521R2000		
48 - 60 V AC/DC	Spring	OBRIC0100-48-60VUC	1SNA645549R1400		
115 - 230 V AC/DC	Spring	OBRIC0100-115-230	1SNA645522R2100		



R600 - 12 mm

2CDC 291 013 50013

MOS-FET output, 58 V DC, 2 A, width 6 mm

Rated control supply voltage	Connection type	Type	Order code	Pkg qty	Weight (1 pc) kg (lb)
5 - 12 V DC	Screw	OBOC2000-5-12VDC	1SNA645050R1700	10	0.02 (0.044)
24 V DC	Screw	OBOC2000-24VDC	1SNA645051R0400		
24 V AC/DC	Screw	OBOC2000-24VUC	1SNA645025R2200		
48 - 60 V AC/DC	Screw	OBOC2000-48-60VUC	1SNA645053R0600		
115 V AC/DC	Screw	OBOC2000-115VUC	1SNA645054R0700		
230 V AC/DC	Screw	OBOC2000-230VUC	1SNA645026R2300		
5 - 12 V DC	Spring	OBROC2000-5-12VDC	1SNA645550R1100	10	0.02 (0.044)
24 V DC	Spring	OBROC2000-24VDC	1SNA645551R0600		
24 V AC/DC	Spring	OBROC2000-24VUC	1SNA645525R2400		
48 - 60 V AC/DC	Spring	OBROC2000-48-60VUC	1SNA645553R0000		
230 V AC/DC	Spring	OBROC2000-230VUC	1SNA645526R2500		

MOS-FET output, 58 V DC, 5 A, width 6 mm

Rated control supply voltage	Connection type	Type	Order code	Pkg qty	Weight (1 pc) kg (lb)
24 V DC	Screw	OBOC5000-24VDC	1SNA645024R2100	10	0.02 (0.044)
115 V AC/DC	Screw	OBOC5000-115VUC	1SNA645058R1300	10	0.02 (0.044)
24 V DC	Spring	OBROC5000-24VDC	1SNA645524R2300		
230 V AC/DC	Spring	OBROC5000-230VUC	1SNA645559R1600		

Triac output, 400 V AC, 1 A, width 6 mm

Rated control supply voltage	Connection type	Type	Order code	Pkg qty	Weight (1 pc) kg (lb)
24 V DC	Screw	OBOA1000-24VDC	1SNA645027R2400	10	0.03 (0.066)
115 V AC/DC	Screw	OBOA1000-115VUC	1SNA645062R0700		
230 V AC/DC	Screw	OBOA1000-230VUC	1SNA645028R0500		
24 V DC	Spring	OBROA1000-24VDC	1SNA645527R2600	10	

Triac output, 230 V AC, 2 A, width 12 mm

Rated control supply voltage	Connection type	Type	Order code	Pkg qty	Weight (1 pc) kg (lb)
24 V DC	Screw	OBOA2000-24VDC	1SNA645029R0600	5	0.03 (0.066)
24 V DC	Spring	OBROA2000-24VDC	1SNA645529R0000	5	

Ordering details - Accessories

Description	Type	Order code	Pkg qty	Weight (1 pc) kg (lb)
Jumper bar, 10 poles	BJ612-10	1SNA290488R0100	10	
Jumper bar, 20 poles	BJ612-20	1SNA206754R0000		
Separator end section	SC612	1SNA290474R0200		
Front marking blank cards, 100 pcs.	RC610	1SNA233000R0100		
Terminal marking blank cards, 100 pcs.	RC65	1SNA232000R0000		

Boxed interface optocouplers R600 range

Connection diagrams

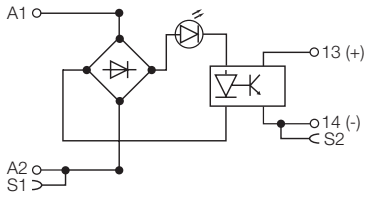

OB(R)OC, OB(R)IC
except 5-12VDC versions

2CDC 292 019 F0016

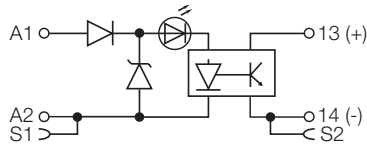

OB(R)IC0100-5-12VDC
OB(R)OC2000-5-12VDC

2CDC 292 017 F0016

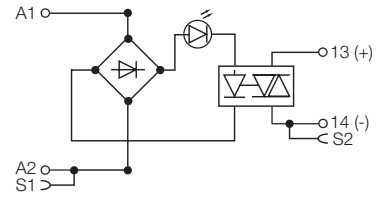

OB(R)OA

2CDC 292 018 F0016

Boxed interface optocouplers R600 range

Technical data

	OB(R)IC0100-...						
	5-12 V DC		24 V DC	48-60 V UC		115-230	
Input circuit							
Input voltage	5 V DC	12 V DC	24 V DC	48 V AC/DC	60 V AC/DC	115 V AC/DC	230 V AC/DC
Frequency	-			50/60 Hz			
Input current	5 mA	9 mA	4 mA	4 mA	5 mA	7 mA (AC) 16 mA (DC)	11.5 mA (AC) 25 mA (DC)
Pull-in voltage	4 V		15 V	25 V		60 V AC / 70 V DC	
Typ. switch-on time	10 µs			5 ms			
Typ. switch-off time	500 µs			20 ms			
Operating frequency	1000 Hz			20 Hz			
Permissible leakage current	0.9 mA		1.0 mA	0.9 mA		1.6 mA	
Output circuit							
11(13+)- 14							
Kind of output	Transistor						
Rated operational voltage	4.5-58 V DC						
Minimum switching current	1 mA						
Maximum switching current	100 mA						
Leakage current at max. switching voltage	< 50 µA						
Rated operational current I _e (IEC/EN 60947-5-1)	DC-12 (resistive) 58 V 0.1 A						
Residual voltage	typical 1 V			maximum 1.3 V			
Max. fuse rating to achieve short-circuit protection	100 mA fast						
Isolation data							
Rated insulation voltage U _i	250 V						
Rated impulse withstand voltage U _{imp}	2.5 kV						
Overvoltage category	II						
Pollution degree	2						

	OB(R)OC2000-...							
	5-12 V DC		24 V DC	24 V UC	48-60 V UC		115 V UC	230 V UC
Input circuit								
Input voltage	5 V DC	12 V DC	24 V DC	24 V AC/DC	48 V AC/DC	60 V AC/DC	115 V AC/DC	230 V AC/DC
Frequency	-			50/60 Hz				
Input current	5 mA	9 mA	5.4 mA	6.3 mA	4 mA	5.1 mA	4.2 mA	4 mA
Pull-in voltage	4 V		12 V	15 V	27 V		50 V	80 V
Typ. switch-on time	15 µs		30 µs	1 ms	5 ms		500 µs	1 ms
Typ. switch-off time	250 µs		400 µs	7 ms	20 ms		10 ms	15 ms
Operating frequency	2000 Hz		1000 Hz	60 Hz	20 Hz		50 Hz	35 Hz
Permissible leakage current	1 mA		0.8 mA	0.9 mA	1 mA		0.3 mA	
Output circuit								
11(13+)- 14								
Kind of output	MOS-FET							
Rated operational voltage	4.5-58 V DC							
Minimum switching current	1 mA							
Maximum switching current	2 A							
Leakage current at max. switching voltage	< 50 µA							
Rated operational current I _e (IEC/EN 60947-5-1)	DC-12 (resistive) 58 V 2 A							
Residual voltage	typical 0.1 V			maximum 0.5 V				
Max. fuse rating to achieve short-circuit protection	2 A ultra-fast							
Isolation data								
Rated insulation voltage U _i	250 V							
Rated impulse withstand voltage U _{imp}	2.5 kV							
Overvoltage category	II							
Pollution degree	2							

Boxed interface optocouplers R600 range

Technical data

5

	OB(R)OC5000-...		
	24VDC	115VUC	230VUC
Input circuit			
Input voltage	24 V DC	115 V AC/DC	230 V AC/DC
Frequency	-	50/60 Hz	-
Input current	5.4 mA	4.2 mA	4 mA
Pull-in voltage	12 V	50 V	80 V
Typ. switch-on time	30 µs	500 µs	1 ms
Typ. switch-off time	400 µs	10 ms	15 ms
Operating frequency	1000 Hz	50 Hz	35 Hz
Permissible leakage current	0.8 mA	0.3 mA	0.3 mA
Output circuit			
Kind of output	11(13+)- 14		
Kind of output	MOS-FET		
Rated operational voltage	4.5-58 V DC		
Minimum switching current	1 mA		
Maximum switching current	5 A		
Leakage current at max. switching voltage	< 50 µA		
Rated operational current DC-12 (resistive) 58 V	5 A		
I _c (IEC/EN 60947-5-1)			
Residual voltage	typical	0.1 V	
	maximum	0.5 V	
Max. fuse rating to achieve short-circuit protection	6 A ultra-fast		
Isolation data			
Rated insulation voltage U _i	250 V		
Rated impulse withstand voltage U _{imp}	2.5 kV		
Overvoltage category	II		
Pollution degree	2		

	OB(R)OA1000-...			OB(R)OA2000-...
	24VDC	115VUC	230VUC	24VDC
Input circuit				
Input voltage	24 V DC	115 V AC/DC	230 V AC/DC	24 V DC
Frequency	-	50/60 Hz	-	-
Input current	3.6 mA	4.15 mA	4.6 mA	3.6 mA
Pull-in voltage	14 V	60 V	135 V	14 V
Typ. switch-on time	150 µs	2.2 ms	2.5 ms	150 µs
Typ. switch-off time	1 ms	18 ms	25 ms	1 ms
Operating frequency	500 Hz	25 Hz	20 Hz	500 Hz
Permissible leakage current	1 mA	-	-	1 mA
Output circuit				
Kind of output	11(13+)- 14			Triac
Kind of output	Triac			Triac
Rated operational voltage	24-400 V AC			10-230 V AC
Minimum switching current	25 mA			25 mA
Maximum switching current	1 A			2 A
Leakage current at max. switching voltage	< 500 µA			< 500 µA
Rated operational current AC-12 (resistive) 400 V	1 A			-
Rated operational current I _c (IEC/EN 60947-5-1) AC-12 (resistive) 230 V	-			2A
Residual voltage	typical	1 V		1 V
	maximum	1.6 V		1.6 V
Max. fuse rating to achieve short-circuit protection	4 A ultra-fast			4 A ultra-fast
Isolation data				
Rated insulation voltage U _i	400 V			230 V
Rated impulse withstand voltage U _{imp}	4 kV			4 kV
Overvoltage category	II			II
Pollution degree	2			2

Boxed interface optocouplers R600 range

Technical data, Dimensions

General technical data - Optocouplers

		OB	OBR
General data			
Material of housing		UL 94 V0	
Mounting		DIN Rail	
Degree of protection	housing / terminals	IP20 NEMA1	
Electrical connection		Screw terminal	Spring-type terminal
Wire size	fine-strand	0.22-2.5 mm ² (24-14 AWG)	
	rigid	0.2-4 mm ² (24-12 AWG)	0.2-2.5 mm ² (24-14 AWG)
Stripping length		9 mm (0.354 in)	
Tightening torque		0.4-0.6 Nm (3.5-5.3 lb.in)	n/a
Environmental data			
Ambient temperature ranges	storage	-40...+80 °C (-40...+176 °F)	
	operation	-20...+70 °C (-4...+158 °F)	
Standards			
Product standards		EN 60947-5-1	
Low Voltage Directive		2014/35/EC	
RoHS Directive		2011/65/EC	

5

Dimensions

in **mm** and inches

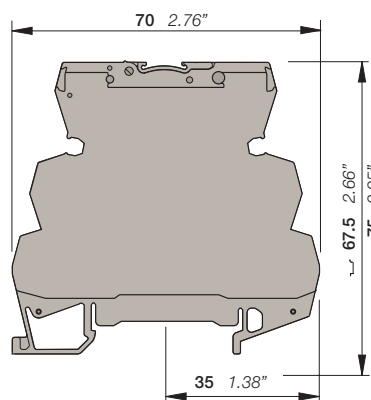

Versions with screw terminals

2CDC 292 025 F0013

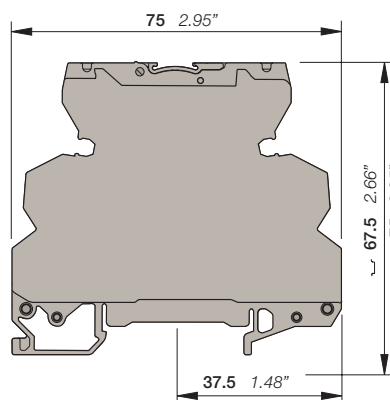

Versions with spring-type terminals

2CDC 292 026 F0013

Logic relays

Product group picture

6



Logic relays

Table of contents

Logic relays

Logic relays	326
System overview	327
Approvals and marks	329
Ordering details - Stand alone logic relays	330
Ordering details - Expandable logic relays	331
Ordering details - Accessories	332
Ordering details - Display systems	333
Technical data	334
Dimensional drawings	348

Logic relays

System overview

Concept

CL range logic relays are suitable for small and medium-sized control tasks and are able to substitute logic wiring in a quick and simple manner.

They can be used for applications in control as well as for timing functions, e.g.

- in buildings, lighting systems, air-conditioning systems, general control functions,
- in small machines and systems or
- as stand-alone control module for small applications.

Steps to the application of CL range

- CL range can be used easily, rapidly and comfortably without any time-consuming planning and programming.
- The user can discover the advantages and the benefit of these logic relays in no time at all.
- CL range provides for the control statements according to a simple circuit diagram.
- Setup, storage, simulation and documentation are performed using the compact and user-friendly CL-SOFT software (CL-LAS.PS002).

6

Software characteristics (CL-SOFT)

- Display on a PC monitor according to IEC, ANSI
- Different languages to choose from
- Easy installation on all Microsoft Windows™ operating systems

Technical data overview

Logic relays

- 8 or 12 digital inputs
- 4 or 6 digital relay outputs
- optionally with 4 or 8 transistor outputs
- 128 rungs
- 3 contacts as n/o or n/c contacts in series plus 1 coil per rung
- optionally with 2 or 4 analog inputs (not 100-240 V AC version)
- power flow display for checking the circuit diagram (devices with display)
- expansions for local or remote level
- enclosure color RAL 7035
- DIN rail mounting

Remote display

- Remote display up to a distance of 5 m
- Illustration of text and status displays
- Remote adjustment via keypad
- Front panel mounting

Logic links instead of wiring

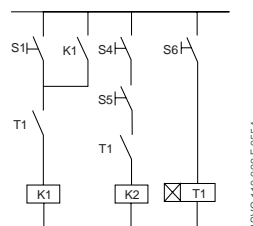

Documentation (download from the internet)

Logic relay manual: 1SVC440795M0100

Remote display manual: 1SVC440795M2100

Display system manual: 1SVC440795M1100

Display system

- useable as compact HMI logic relay
- fully graphic, backlit display module
- 12 digital inputs
- 4 digital relay outputs
- optionally with 4 transistor outputs
- 256 rungs
- 4 contacts as n/o or n/c contacts in series plus 1 coil per rung
- optionally with 4 analog inputs (not 100-240 V AC version)
- networking-compatible via CL-NET
- front panel mounting
- expansion for local

Software

- 16 timing relays 0.01-99:59 h
- 16 counting relays for up-, down counting
- 8 weekly timer, 8 annual timers
- 16 analog value comparators
- 16 freely editable display texts
- 32 markers or auxiliary relays

Logic relays

System overview

Logic relays

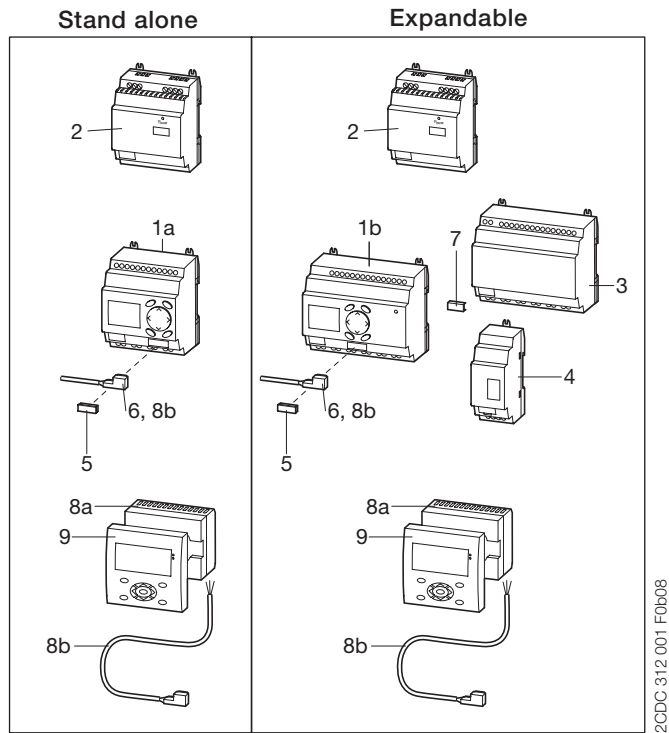

- 1a Logic relay CL-LS..
- 1b Expandable logic relay CL-LM..
- 2 Power supply CP-D...
- 3 I/O expansion CL-LER..., CL-LET.. for logic relays CL-LM..
- 4 Coupler unit CL-LEC.. for remote expansion of logic relays CL-LM..
- 5 Memory module CL-LAS.MD003 for logic relays CL-LS..., CL-LM..
- 6 Connecting cable CL-LAS.TK001, CL-LAS.TK002 to connect PC CL-LINK plug CL-LAS.TK011 to connect expansion to logic relays CL-LM..
- 7 CL-LINK plug CL-LAS.TK011 to connect expansion to logic relays CL-LM..
- 8a Remote display connection module CL-LDC.S..
- 8b Connecting cable CL-LAD.TK007 to connect a remote displays to a logic relay
- 9 Display module CL-LDD..

Expansion of logic relays*

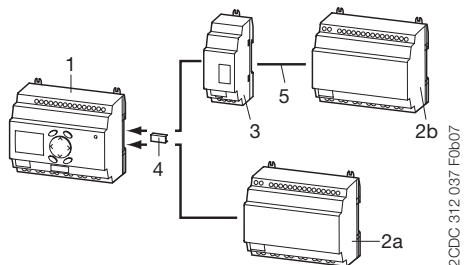

- 1 Logic relay CL-LM..
- 2 I/O expansion CL-LER..., CL-LET..
- 2a local expansion
- 2b remote expansion
- 3 Coupler unit CL-LEC.. for remote expansion of logic relays CL-LM..
- 4 CL-LINK plug CL-LAS.TK011 for expansion of logic relays CL-LM.. up to 30 m

* max. 1 expansion per logic relay

Display system → Compact HMI logic relay

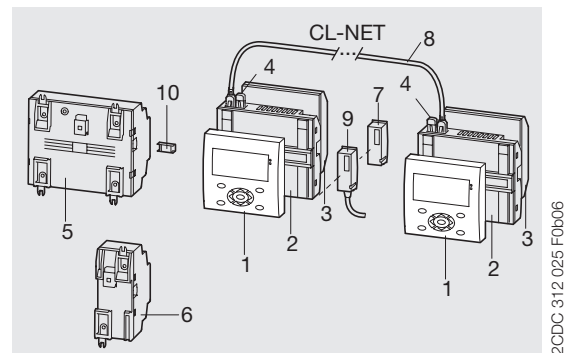

- 1 Display module CL-LDD..
- 2 Display base module CL-LDC.LN..
- 3 Display I/O module CL-LDR..., CL-LDT..
- 4 Termination resistor CL-LAD.TK009
- 5 I/O expansion CL-LER..., CL-LET..
- 6 Coupler unit CL-LEC.. for remote expansion
- 7 Memory module CL-LAD.MD004 for display base module
- 8 Connecting cable CL-LAD.TK002, CL-LAD.TK003, CL-LAD.TK004
- 9 Connecting cable CL-LAD.TK001, CL-LAD.TK011 to connect PC
- 10 CL-LINK plug CL-LAS.TK011 for expansion of logic relays CL-LM.. e.g. door of switchgear cabinet

Stand alone with I/O module

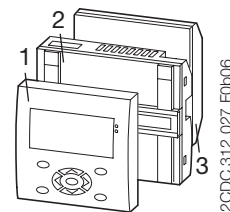

- 1 Display CL-LDD..
- 2 Remote display connection module CL-LDC.S.. incl. connecting cable
- 3 Display base module CL-LDC.L..

Communication via CL-NET

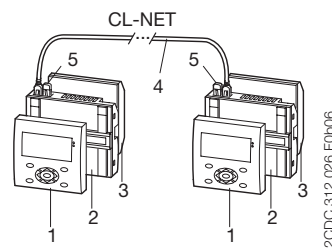









- 1 Display CL-LDD..
- 2 Display base module CL-LDC.LN.. for CL-NET
- 3 Display I/O module CL-LDR..., CL-LDT..
- 4 Connecting cable CL-LAD.TK002, CL-LAD.TK003, CL-LAD.TK004
- 5 Termination resistor CL-LAD.TK009

Logic relays

Approvals and marks

- existing
- pending

		Logic relays				Expansions			Display system				Accessories	
		CL-LSR	CL-LST	CL-LMR	CL-LMT	CL-LEK	CL-LET	CL-LEC	CL-LDD	CL-LDC	CL-LDR	CL-LDT	CL-LAS	CL-LAD
Approvals														
	UL	■	■	■	■	■	■	■	■	■	■	■	■ ¹⁾	■ ²⁾
	CAN/CSA C22.2 No.14	■	■	■	■	■	■	■	■	■	■	■	■ ¹⁾	■ ²⁾
	CAN/CSA C22.2 No.213 (hazardous locations)	■	■	■	■	■	■	■	■	■	■	■	■ ¹⁾	■ ²⁾
	GL	■	■	■	■				■	■ ³⁾	■ ⁴⁾	■		
	EAC	□	□	□	□	□	□	□	□	□	□	□	□	□
	Lloyds Register	■	■	■	■				■	■ ³⁾	■ ⁴⁾	■		
Marks														
	CE	■	■	■	■	■	■	■	■	■	■	■	■	■
	C-Tick	□	□	□	□	□	□	□	□	□	□	□	□	□

¹⁾ not for: CL-LAS-PS002, CL-LAS.TD001, CL-LAS.FD001, CL-LAS.TK002, CL-LAS.TK011

²⁾ not for: CL-LAD.TK006, CL-LAD.TK011, CL-LAD.FD002

³⁾ not for: CL-LDC.SDC2, CL-LDC.SAC2, CL-LDC.LAC2, CL-LDC.LNAC2

⁴⁾ not for: CL-LDR.16AC2

Logic relays

Ordering details - Stand alone logic relays



2CDC 281 034 F0006

CL-LSR



2CDC 281 033 F0006

CL-LST

Ordering details - Logic relays stand alone

Rated operational voltage	Display + Keypad	Timer	Input / Output	Type	Order code	Price 1 pce	Weight (1 pce) kg (lb)
24 V AC	■	■	8 inputs / 4 relay outputs	CL-LSR.C12AC1	1SVR440712R0300		0.20 (0.44)
				CL-LSR.CX12AC1	1SVR440712R0200		
100-240 V AC	■	■		CL-LSR.12AC2	1SVR440713R0100		
				CL-LSR.C12AC2	1SVR440713R0300		
12 V DC	■	■		CL-LSR.CX12AC2	1SVR440713R0200		
				CL-LSR.C12DC1	1SVR440710R0300		
24 V DC	■	■		CL-LSR.CX12DC1	1SVR440710R0200		
				CL-LSR.12DC2	1SVR440711R0100		
24 V DC	■	■		CL-LSR.C12DC2	1SVR440711R0300		
				CL-LSR.CX12DC2	1SVR440711R0200		
			CL-LST.C12DC2	1SVR440711R1300			
24 V DC	■	■	CL-LST.CX12DC2	1SVR440711R1200			



2CDC 281 028 F0006

CL-LDD.K

Ordering details - Display modules

Rated operational voltage	Description	Type	Order code	Price 1 pce	Weight (1 pce) kg (lb)
-	Graphic display 132 x 64 pixel	CL-LDD.XK	1SVR440839R4500		0.14 (0.30)
-	Graphic display 132 x 64 pixel, with keypad	CL-LDD.K	1SVR440839R4400		0.13 (0.29)
24 V DC	Module to displace the display from the logic relay, incl. connecting cable CL-LAD.	CL-LDC.SDC2	1SVR440841R0000		0.16 (0.36)
100-240 V AC	TK007, 5m, lenght adaptable	CL-LDC.SAC2	1SVR440843R0000		0.16 (0.36)



2CDC 281 017 F0007

CL-LDC.S..

Logic relays

Ordering details - Expandable logic relays



2CDC 311 038 F0006

CL-LMR



2CDC 311 037 F0007

CL-LER



2CDC 311 038 F0006

CL-LEC

Ordering details - Logic relays expandable

Rated operational voltage	Display + Keypad	Timer	Input / Output	Type	Order code	Price 1 pce	Weight (1 pce) kg (lb)
24 V AC	■	■	12 inputs / 6 relay outputs	CL-LMR.C18AC1	1SVR440722R0300		0.36 (0.79)
100-240 V AC	■	■		CL-LMR.CX18AC1	1SVR440722R0200		
				CL-LMR.C18AC2	1SVR440723R0300		
12 V DC	■	■		CL-LMR.CX18AC2	1SVR440723R0200		
				CL-LMR.C18DC1	1SVR440720R0300		
24 V DC	■	■		CL-LMR.CX18DC1	1SVR440720R0200		
			CL-LMR.C18DC2	1SVR440721R0300			
24 V DC	■	■	12 inputs, 8 transistor outputs	CL-LMT.C20DC2	1SVR440721R1300		0.36 (0.79)
				CL-LMT.CX20DC2	1SVR440721R1200		

Ordering details - Expansions

Rated operational voltage	Description	Type	Order code	Price 1 pce	Weight (1 pce) kg (lb)
-	2 relay outputs	CL-LER.20	1SVR440709R5000		0.07 (0.15)
100-240 V AC	12 inputs, 6 relay outputs	CL-LER.18AC2	1SVR440723R0000		0.26 (0.57)
24 V DC		CL-LER.18DC2	1SVR440721R0000		0.22 (0.49)
24 V DC	12 inputs, 8 transistor outputs	CL-LET.20DC2	1SVR440721R1000		0.21 (0.46)
-	Coupler unit for remote expansion with a distance of up to 30 m	CL-LEC.CI000	1SVR440709R0000		0.07 (0.15)

Logic relays

Ordering details - Accessories



CL-LAS.PS002



CL-LAS.TK001



CL-LAS.MD003

2CDC 311 012 F0007

2CDC 311 014 F0007

2CDC 311 013 F0007

Ordering details - CL-LA...

Description	Type	Order code	Price 1 pce	Weight (1 pce) kg (lb)
Software for programming and control of CL range devices. Installation CD-ROM for Microsoft Windows™.	CL-LAS.PS002	1SVR440799R8000		0.10 (0.21)
Memory module for logic relays Memory size: 32 kB	CL-LAS.MD003	1SVR440799R7000		0.02 (0.04)
Cable with serial interface to connect PC and logic relay. Length: 2 m	CL-LAS.TK001	1SVR440799R6000		0.10 (0.22)
Cable with USB interface to connect PC and logic relay. Length: 2 m	CL-LAS.TK002	1SVR440799R6100		0.06 (0.13)
Cable for point-to-point connection of remote-display connection module and logic relay, length: 5m, adaptable	CL-LAD.TK007	1SVR440899R6600		0.20 (0.44)
Fixing brackets for screw mounting of logic relay, expansion, display base module	CL-LAS.FD001	1SVR440799R5000		0.01 (0.01)
Spare plug (CL-LINK) for connection of logic relay to expansion	CL-LAS.TK011	1SVR440799R5100		0.10 (0.22)
Primary switch mode power supplies, Rated input voltage: 100-240 V AC Rated output voltage/current: 24 V DC / 0.42 A	CP-D 24/0.421)	1SVR427041R0000		0.06 (0.13)
Primary switch mode power supplies, Rated input voltage: 100-240 V AC Rated output voltage/current: 24 V DC / 1.3 A	CP-D 24/1.32)	1SVR427043R0100		0.19 (0.41)

¹⁾ replaces CL-LAS.SD001, technical data see chapter "Primary switch mode power supplies"

²⁾ replaces CL-LAS.SD002, technical data see chapter "Primary switch mode power supplies"

Logic relays

Ordering details - Display systems



CL-LDD.K

2CDC 311 028 F0006



CL-LDC.LN..

2CDC 311 031 F0006

Ordering details - Display systems

Rated operational voltage	Description	Type	Order code	Price 1 pce	Weight (1 pce) kg (lb)
-	Display module Graphic display 132 x 64 pixel	CL-LDD.XK	1SVR440839R4500		0.14 (0.30)
-	Display module Graphic display 132 x 64 pixel, with keypad	CL-LDD.K	1SVR440839R4400		0.13 (0.29)
24 V DC	Display base module CPU / power supply	CL-LDC.LDC2	1SVR440821R0000		0.16 (0.36)
100-240 V AC		CL-LDC.LAC2	1SVR440823R0000		
24 V DC	Display base module CPU / power supply, networking-compatible (CL-NET)	CL-LDC.LNDC2	1SVR440821R1000		0.17 (0.38)
100-240 V AC		CL-LDC.LNAC2	1SVR440823R1000		
100-240 V AC	Display I/O module 12 inputs, 4 relay outputs	CL-LDR.16AC2	1SVR440853R0000		0.17 (0.38)
24 V DC		CL-LDR.16DC2	1SVR440851R0000		
24 V DC	Display I/O module 12 inputs, 4 relay outputs, 1 analog output	CL-LDR.17DC2	1SVR440851R2000		0.17 (0.38)
24 V DC	Display I/O module 12 inputs, 4 transistor outputs	CL-LDT.16DC2	1SVR440851R1000		0.14 (0.30)
24 V DC	Display I/O module 12 inputs, 4 transistor outputs, 1 analog output	CL-LDT.17DC2	1SVR440851R3000		0.14 (0.30)

Ordering details - CL-LAD...

Description	Type	Order code	Price 1 pce	Weight (1 pce) kg (lb)
Memory module for display base modules Memory size: 256 kB	CL-LAD.MD004	1SVR440899R7000		0.02 (0.03)
Cable with serial interface to connect PC and display base module	CL-LAD.TK001	1SVR440899R6000		0.11 (0.23)
Cable with USB interface to connect PC and display base module	CL-LAD.TK011	1SVR440899R6700		
Network cable (CL-NET) to connect 2 display base modules Length: 0.3 m	CL-LAD.TK002	1SVR440899R6100		0.05 (0.12)
Network cable (CL-NET) to connect 2 display base modules Length: 0.8 m	CL-LAD.TK003	1SVR440899R6200		0.07 (0.14)
Network cable (CL-NET) to connect 2 display base modules Length: 1.5 m	CL-LAD.TK004	1SVR440899R6300		0.08 (0.18)
Cable for point-to-point connection of remote display connection modules and display base module, length adaptable, Length: 5 m	CL-LAD.TK005	1SVR440899R6400		0.20 (0.44)
Cable for point-to-point connection of 2 display base modules, length adaptable. Length: 5 m	CL-LAD.TK006	1SVR440899R6500		0.12 (0.26)
Termination resistor, content: 2 pieces	CL-LAD.TK009	1SVR440899R6900		0.01 (0.02)
Protective cover, transparent, for harsh environmental conditions and application in the food industry	CL-LAD.FD001	1SVR440899R1000		0.03 (0.07)
Protective cover, transparent and sealable	CL-LAD.FD011	1SVR440899R2000		0.03 (0.07)
Assembly tool for mounting of display modules	CL-LAD.FD002	1SVR440899R3000		

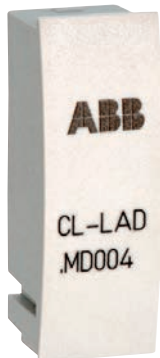

CL-LAD.MD004

2CDC 311 018 F0007



CL-LAD.TK001

2CDC 311 019 F0007



CL-LAD.TK002

2CDC 311 020 F0006

Logic relays

Technical data

Data at $T_a = 25\text{ °C}$ and rated values, if nothing else indicated.

Type	CL-LSR.C...12DC1	CL-LSR...12DC2 CL-LST.C...12DC2	CL-LSR.C...12AC1	CL-LSR...12AC2
Input circuit - supply circuit				
Rated operational voltage U_o	12 V DC	24 V DC	24 V AC	100-240 V AC
Rated operational voltage tolerance	-15...+30 %	-15...+20 %	-15...+10 %	-
Operational voltage range	10.2-15.6 V DC	20.4-28.8 V DC	20.4-26.4 V AC	85-264 V AC
Rated frequency	0 Hz	-	50/60 Hz	-
Rated frequency tolerance	-	-	±5 %	-
Residual ripple	≤ 5 %	-	-	-
Input current	at 12 V DC typ. 140 mA	-	-	-
	at 24 V DC	typ. 80 mA	-	-
	at 24 V AC	-	typ. 200 mA	-
	at 115/120 V AC (60 Hz)	-	-	typ. 40 mA
	at 230/240 V AC (50 Hz)	-	-	typ. 20 mA
Power failure buffering (IEC/EN 61131-2)	10 ms	-	20 ms	-
Power dissipation	at 12 V DC typ. 2 W	-	-	-
	at 24 V DC	typ. 2 W	-	-
	at 24 V AC	-	typ. 5 VA	-
	at 115/120 V AC	-	-	typ. 5 VA
	at 230/240 V AC	-	-	typ. 5 VA
Type	CL-LMR.C...18DC1	CL-LMR.C...18DC2 CL-LMT.C...20DC2	CL-LMR.C...18AC1	CL-LMR.C...18AC2
Input circuit - supply circuit				
Rated operational voltage U_o	12 V DC	24 V DC	24 V AC	100-240 V AC
Rated operational voltage tolerance	-15...+30 %	-15...+20 %	-15...+10 %	-
Operational voltage range	10.2-15.6 V DC	20.4-28.8 V DC	20.4-26.4 V AC	85-264 V AC
Rated frequency	0 Hz	-	50/60 Hz	-
Rated frequency tolerance	-	-	±5 %	-
Residual ripple	≤ 5 %	-	-	-
Input current	at 12 V DC typ. 200 mA	-	-	-
	at 24 V DC	typ. 140 mA	-	-
	at 24 V AC	-	typ. 300 mA	-
	at 115/120 V AC (60 Hz)	-	-	typ. 70 mA
	at 230/240 V AC (50 Hz)	-	-	typ. 35 mA
Power failure buffering (IEC/EN 61131-2)	10 ms	-	20 ms	-
Power dissipation	at 12 V DC typ. 3.5 W	-	-	-
	at 24 V DC	typ. 3.5 W	-	-
	at 24 V AC	-	typ. 7 VA	-
	at 115/120 V AC	-	-	typ. 10 VA
	at 230/240 V AC	-	-	typ. 10 VA
Type	CL-LER.18DC2 CL-LET.20DC2	CL-LER.18AC2		
Input circuit - supply circuit				
Rated operational voltage U_o	24 V DC	100-240 V AC		
Rated operational voltage tolerance	-15...+20 %	-15...+10 %		
Operational voltage range	20.4-28.8 V DC	85-264 V AC		
Rated frequency	0 Hz	50/60 Hz		
Rated frequency tolerance	-	±5 %		
Residual ripple	≤ 5 %	-		
Input current	at 24 V DC typ. 140 mA	-		
	at 115/120 V AC (60 Hz)	typ. 70 mA		
	at 230/240 V AC (50 Hz)	typ. 35 mA		
Power failure buffering (IEC/EN 61131-2)	10 ms	20 ms		
Power dissipation	at 24 V DC typ. 3.4 W	-		
	at 115/120 V AC	typ. 10 VA		
	at 230/240 V AC	typ. 10 VA		

Logic relays

Technical data

Data at $T_a = 25\text{ °C}$ and rated values, if nothing else indicated.

Type		CL-LSR.C...12DC1	CL-LSR...12DC2 CL-LST.C...12DC2	CL-LSR.C...12AC1	CL-LSR.C...12AC2
Input circuit - Digital inputs					
Number		8			
Inputs can be used as analog inputs		2 (I7, I8)			-
Indication of operational states		LCD-Display (if existing)			
Electrical isolation	from voltage supply	no			
	between digital inputs	no			
	from the outputs	yes			
Rated operational voltage U_o		12 V DC	24 V DC	24 V AC	
	U_o on „0“ signal	4 V DC (I1-I8)	< 5 V DC (I1-I8)	0-6 V AC (sinusoidal)	0-40 V AC (sinusoidal)
	U_o on „1“ signal	8 V DC (I1-I8)	> 15 V DC (I1-I6), > 8 V DC (I7, I8)	> 9.5 V DC, 14-26.4 V AC (sinusoidal) (I1-I6), > 7 V AC (sinusoidal) (I7, I8)	79-264 V AC (sinusoidal)
Rated frequency		-		50-60 Hz	
Input current on „1“ signal		3.3 mA (at 12 V DC, I1-I6), 1.1 mA (at 12 V DC, I7, I8)	3.3 mA (at 24 V DC, I6-I7), 2.2 mA (at 24 V DC, I7, I8)	4 mA (at 24 V AC, 50 Hz, I1-I6), 2 mA (at 24 V AC, 50 Hz, I7, I8), 2 mA (at 24 V DC, I7, I8)	6x0.25 mA (at 115 V AC, 60 Hz, I1-I6), 6x0.5 mA (at 230 V AC, 50 Hz, I1-I6), 2x4 mA (at 115 V AC, 60 Hz, I7, I8), 2x6 mA (at 230 V AC, 50 Hz, I7, I8)
Time delay from „0“ to „1“	debounce ON	20 ms		80 ms (at 50 Hz), 66 2/3 ms (at 60 Hz)	
	debounce OFF	typ. 0.3 ms (I1-I6), typ. 0.35 ms (I7, I8)	typ. 0.25 ms (I1-I8)	20 ms (at 50 Hz), 16 2/3 ms (at 60 Hz)	
Time delay from „1“ to „0“	debounce ON	20 ms		80 ms (at 50 Hz), 66 2/3 ms (at 60 Hz)	80 ms (at 50 Hz, I1-I6), 66 2/3 ms (at 60 Hz, I1-I6), 160 ms (at 50 Hz, I7, I8), 150 ms (at 60 Hz, I7, I8)
	debounce OFF	typ. 0.3 ms (I1-I6), typ. 0.15 ms (I7, I8)	-	20 ms (at 50 Hz), 16 2/3 ms (at 60 Hz)	20 ms (at 50 Hz, I1-I6), 16 2/3 ms (at 60 Hz, I1-I6), 100 ms (at 50 Hz, I7, I8), 100 ms (at 60 Hz, I7, I8)
Cable length (unshielded)		100 m			
Maximum cable length per input		-		40 m	40 m (I1-I6), 100 m (I7, I8)
Frequency counter	Number	2 (I3, I4)			
	counting frequency	< 1 kHz			
	pulse shape	square-wave			
	pulse / pause ratio	1:1			
Rapid counter inputs	Number	2 (I1, I2)			
	counting frequency	< 1 kHz			
	pulse shape	square-wave			
	pulse / pause ratio	1:1			
Cable length (shielded)		< 20 m			
Input circuit - Analog inputs					
Number		2 (I7, I8)			
Electrical isolation	from voltage supply	no			
	from the digital inputs	no			
	from the outputs	yes			
	from PC interface, memory module, CL-NET, CL-LINK	no			
Input type		DC voltage			
Signal range		0-10 V DC			
Resolution	analog	0.01 V			
	digital	0.01 V; 10 Bit (value 1-1023)			
Input impedance		11.2 k Ω			
Accuracy of the actual value	two CL devices	$\pm 3\%$			
	within one device	$\pm 2\%$, $\pm 0.12\text{ V}$			
Conversion time analog/digital	Input delay ON	20 ms			
	Input delay OFF	each cycle			
Input current		< 1 mA			
Cable length (shielded)		< 30 m			

Logic relays

Technical data

Data at $T_a = 25\text{ °C}$ and rated values, if nothing else indicated.

Type	CL-LMR.C...18DC1	CL-LMR.C...18DC2 CL-LMT.C...20DC2	CL-LMR.C...18AC1	CL-LMR.C...18AC2
Input circuit - Digital inputs	12 V DC	24 V DC	24 V AC	115 / 230 V AC
Number	12			
Inputs can be used as analog inputs	4 (I7, I8, I11, I12)			-
Indication of operational states	LCD-Display (if existing)			
Electrical isolation				
from voltage supply	no			
between digital inputs	no			
from the outputs	yes			
from PC interface,	no			yes
memory module, CL-NET,				
CL-LINK				
Rated operational voltage U_e				
U_e on „0“ signal	12 V DC 4 V DC (I1-I12)	24 V DC < 5 V DC (I1-I12, R1-R12)	24 V AC 0-6 V AC (sinusoidal)	0-40 V AC (sinusoidal)
U_e on „1“ signal	8 V DC (I1-I12)	> 15 V DC (I1-I6, I9, I10) > 8 V DC (I7, I8, I11, I12)	> 9.5 V DC, 14-26.4 V AC (sinusoidal) (I1-I6, I9, I10) > 7 V AC (sinusoidal) (I7, I8; I11, I12)	79-264 V AC (sinusoidal)
Rated frequency	-		50-60 Hz	
Input current on „1“ signal	3.3 mA (at 12 V DC, I1-I6, I9-I12), 1.1 mA (at 12 V DC, I7, I8)	3.3 mA (at 24 V DC, I1-I6, I9, I10), 2.2 mA (at 24 V DC, I7, I8, I11, I12)	4 mA (at 24 V AC, 50 Hz, I1-I6, I9, I10), 2 mA (at 24 V AC, 50 Hz, I7, I8, I11, I12), 2 mA (at 24 V DC, I7, I8, I11, I12)	6x0.25 mA (at 115 V AC, 60 Hz, I1-I6), 6x0.5 mA (at 230 V AC, 50 Hz, I1-I6) 2x4 mA (at 115 V AC, 60 Hz, I7, I8), 2x6 mA (at 230 V AC, 50 Hz, I7, I8), 4x0.25 mA (at 115 V AC, 60 Hz, I9-I12), 4x0.5 mA (at 230 V AC, 50 Hz, I9-I12)
Time delay from „0“ to „1“	debounce ON 20 ms debounce OFF typ. 0.3 ms (I1-I6, I9, I10), typ. 0.35 ms (I7, I8, I11, I12)	typ. 0.25 ms	80 ms (at 50 Hz), 66 2/3 ms (at 60 Hz) 20 ms (at 50 Hz), 16 2/3 ms (at 60 Hz)	
Time delay from „1“ to „0“	debounce ON 20 ms debounce OFF typ. 0.4 ms (I1-I6, I9, I10), typ. 0.35 ms (I7, I8, I11, I12)	-	80 ms (at 50 Hz), 66 2/3 ms (at 60 Hz) 20 ms (at 50 Hz), 16 2/3 ms (at 60 Hz)	
Cable length (unshielded)	100 m			
Maximum cable length per input			max. 40 m, typ. 40 m (I9, I10)	typ. 40 m (I1-I6, I9-I12), typ. 100 m (I7, I8)
Frequency counter				
number	2 (I3, I4)			
counting frequency	< 1 kHz			
pulse shape	square-wave			
pulse / pause ratio	1:1			
Rapid counter inputs				
number	2 (I1, I2)			
counting frequency	< 1 kHz			
pulse shape	square-wave			
pulse / pause ratio	1:1			
Cable length (shielded)	< 20 m			
Input circuit - Analog inputs				
Number	4 (I7, I8, I11, I12)			
Electrical isolation				
from voltage supply	no			
from the digital inputs	no			
from the outputs	yes			
from PC interface,	no			
memory module, CL-NET,				
CL-LINK				
Input type	DC voltage			
Signal range	0-10 V DC			
Resolution	analog 0.01 V digital 0.01 V; 10 Bit (value 1-1023)			
Input impedance	11.2 k Ω			
Accuracy of the actual value	two CL devices $\pm 3\%$ within one device $\pm 2\%$, $\pm 0.12\text{ V}$			
Conversion time	Input delay ON 20 ms			
analog/digital	Input delay OFF each cycle			
Input current	< 1 mA			
Cable length (shielded)	< 30 m			

Logic relays

Technical data

Data at $T_a = 25\text{ °C}$ and rated values, if nothing else indicated.

Type		CL-LER.18DC2, CL-LET.20DC2	CL-LER.18AC2
Input circuit - Digital inputs		24 V DC	115 / 230 V AC
Number		12	
Inputs can be used as analog inputs		-	
Indication of operational states		-	
Electrical isolation	from voltage supply	no	
	between digital inputs	no	
	from the outputs	yes	
	from PC interface, memory module, CL-NET, CL-LINK	no	
Rated operational voltage U_e		24 V DC	
	U_e on „0“ signal	< 5 V DC (I1-I12, R1-R12)	0-40 V AC (sinusoidal)
	U_e on „1“ signal	-	79-264 V AC (sinusoidal)
Rated frequency		-	50-60 Hz
Input current on „1“ signal		3.3 mA (at 24 V DC, R1-R12)	12x0.25 mA (at 115 V AC, 60 Hz, R1-R12), 12x0.5 mA (at 230 V AC, 50 Hz, R1-R12)
	Time delay from „0“ to „1“	debounce ON	20 ms
Time delay from „1“ to „0“	debounce OFF	typ. 0.25 ms (R1-R12)	20 ms (at 50 Hz, I1-I12, R1-R12), 16 2/3 ms (at 60 Hz, I1-I12, R1-R12)
	debounce ON	20 ms	80 ms (at 50 Hz, I1-I12, R1-R12), 66 2/3 ms (at 60 Hz, I1-I12, R1-R12)
Cable length (unshielded)	debounce OFF	-	20 ms (at 50 Hz, I1-I12, R1-R12), 16 2/3 ms (at 60 Hz, I1-I12, R1-R12)
		100 m	-
Maximum cable length per input		-	typ. 40 m (I1-I6, I9-I12, R1-R12), typ. 100 m (I7, I8)

6

Logic relays

Technical data

Data at $T_a = 25\text{ °C}$ and rated values, if nothing else indicated.

Type	CL-LSR...	CL-LMR... CL-LER...	CL-LER.20
Output circuit - Relay outputs			
Number	4	6	2
Outputs in groups of	1		2
Parallel switching of outputs to increase capacity	not permissible		
Fusing of the output relay	circuit-breaker B16 or fuse 8 A (slow-acting)		
Electrical isolation	from voltage supply	yes	
	from the inputs	yes	
	from PC interface, memory module, CL-NET, CL-LINK	no	
	protective separation	300 V AC	
	basic isolation	600 V AC	
Mechanical lifetime	10x10 ⁶ switching cycles		
Rung	conventional thermal current (10 A UL)	8 A	
	recommended for load 12 V AC/DC	> 500 mA	
	short-circuit proof $\cos \varphi = 1$; characteristic B16 at 600 A	16 A	
	short-circuit proof $\cos \varphi = 0,5$ up to 0,7; characteristic B16 at 900 A	16 A	
	Rated impulse withstand voltage U_{imp} contact-coil	6 kV	
	Rated operational voltage U_o	250 V AC	
	Rated insulation voltage U_i	250 V AC	
Protective separation (EN 50178)	between coil and contact	300 V AC	
	between two contacts	300V AC	
Making capacity	AC-15, 250 V AC, 3 A (600 ops./h)	300.000 switching cycles	
	DC13, L/R \leq 150 ms, 24 V DC, 1 A (500 ops./h)	200.000 switching cycles	
Breaking capacity	AC-15, 250 V AC, 3 A (600 ops./h)	300.000 switching cycles	
	DC13, L/R \leq 150 ms, 24 V DC, 1 A (500 ops./h)	200.000 switching cycles	
Incandescent lamp load	1000 W at 230/240 V AC	25.000 switching cycles	
	500 W at 115/120 V AC	25.000 switching cycles	
Fluorescent lamp load	10 x 58 W at 230/240 V AC with electrical control gear	25.000 switching cycles	
	10 x 58 W at 230/240 V AC uncompensated	25.000 switching cycles	
	1 x 58 W at 230/240 V AC conventional compensated	25.000 switching cycles	
	1 x 58 W at 230/240 V AC mechanical operations	10x10 ⁶	
Switching frequency	switching frequency	10 Hz	
	resistive load / lamp load	2 Hz	
	inductive load	0.5 Hz	
UL/CSA			
Continuous current at 240 V	10 A AC		
Continuous current at 24 V	8 A DC		
AC	Utilization category (Control Circuit Rating Codes)	B 300 Light Pilot Duty	
	max. rated operational voltage	300 V AC	
	max. continuous thermal current $\cos \varphi = 1$ at B 300	5 A	
	max. making / breaking apparent power (Make/Break) $\cos \varphi \neq 1$ at B 300	3600/360 VA	
DC	Utilization category (Control Circuit Rating Codes)	R 300 Light Pilot Duty	
	max. rated operational voltage	300 V DC	
	max. continuous thermal current at R 300	1 A	
	max. making / breaking apparent power (Make/Break) at R 300	28/28 VA	

Logic relays

Technical data

Data at $T_a = 25\text{ °C}$ and rated values, if nothing else indicated.

Type	CL-LST...	CL-LMT...	CL-LET...
Output circuit - Transistor outputs			
Number	4	8	
Rated operational voltage U_o	24 V DC		
Operational voltage range	20.4-28.8 V DC		
Residual ripple	$\leq 5\%$		
Supply current	on „0“ signal typ. 9 mA / max. 16 mA	typ. 18 mA / max. 32 mA	
	on „1“ signal	typ. 12 mA / max. 22 mA	typ. 24 mA / max. 44 mA
Reverse voltage protection	yes (Attention: If supply voltage is reversed, applying voltage at the outputs, causes a short circuit.)		
Electrical isolation	from voltage supply	yes	
	from the inputs	yes	
	from PC interface, memory module, CL-NET, CL-LINK	-	
Rated operational current I_o on „1“ signal DC	max. 0.5 A		
Lamp load without R_v	5 W		
Residual current on „0“ signal per channel	$< 0.1\text{ mA}$		
Max. output voltage	on „0“ signal at external load $< 10\text{ M}\Omega$	2.5 V	
	on „1“ signal at $I_e = 0.5\text{ A}$	$U = U_e - 1\text{ V}$	
Short-circuit protection	yes, thermal (analysis results from diagnosis input I16, I15; R15, R16)		
Short-circuit tripping current for $R_a \leq 10\text{ m}\Omega$	$0.7\text{ A} \leq I_o \leq 2\text{ A}$ per output		
Total short-circuit current	8 A	16 A	
Peak short-circuit current	16 A	32 A	
Thermal tripping	yes		
Max. switching frequency with constant resistive load $R_L < 100\text{ k}\Omega$ (depending on active channels and their load)	40.000 switching cycles/h		
Parallel connection of outputs	with resistive load, inductive load with external suppressor, combination within one group	group 1: Q1-Q4 group 2: Q5-Q8	group 1: S1-S4, group 2: S5-S8
	number of outputs	max. 4	
	max. total current	2 A (Attention! Outputs must be actuated simultaneously and for the same length of time.)	
Indication of operational states of the outputs	LCD-Display (if existing)		
Inductive load ¹⁾ without external suppressor			
$T_{0.95} = 1\text{ ms}$,	utilization factor	0.25 g	
$R = 48\ \Omega$,	duty time	100 %	
$L = 16\text{ mH}$	max. switching frequency $f = 0.5\text{ Hz}$ (max. duty time = 50 %)	1500 switching cycles	
DC13,	utilization factor	0.25 g	
$T_{0.95} = 72\text{ ms}$,	duty time	100 %	
$R = 48\ \Omega$,	max. switching frequency $f = 0.5\text{ Hz}$ (max. duty time = 50 %)	1500 switching cycles	
$L = 1.15\text{ H}$			
$T_{0.95} = 15\text{ ms}$,	utilization factor	0.25 g	
$R = 48\ \Omega$,	duty time	100 %	
$L = 0.24\text{ H}$	max. switching frequency $f = 0.5\text{ Hz}$ (max. duty time = 50 %)	1500 switching cycles	
Inductive load ¹⁾ with external suppressor	demand factor	1 g	
	duty time	100 %	
	max. switching frequency	depends on suppressor	
	max. duty time		

1) For inductive loading, without external suppression of the transistor outputs, the following applies:

$T_{0.95}$ = time in ms, until 95 % of the steady-state current is achieved. $T_{0.95} \cdot 3 \times T_{0.65} = 3 \times L/R$.

Data transfer rate in the CL-NET network: bus lengths of 40 m and over only attainable with cables with additional cross-section and connection adapter.

Logic relays

Technical data

Data at $T_a = 25\text{ °C}$ and rated values, if nothing else indicated.

Type	CL-LSR..., CL-LST...	CL-LMR... CL-LMT... CL-LET..., CL-LER.18..	CL-LER.20 CL-LEC.CI000
General data			
Dimensions (W x H x D)	71.5 mm x 90 mm x 58 mm (2.81 inch x 3.54 inch x 2.28 inch)	107.5 mm x 90 mm x 58 mm (4.23 inch x 3.54 inch x 2.28 inch)	35.5 mm x 90 mm x 58 mm (1.40 inch x 3.54 inch x 2.28 inch)
Weight	0.2 kg (0.44 lb)	0.3 kg (0.66 lb)	0.07 kg (0.15 lb)
Mounting	DIN rail (IEC/EN 60715), 35 mm or screw mounting with fixing brackets CL-LAS.FD001 (accessories)		
Mounting position	horizontal / vertical		
Electrical connection			
Wire size	rigid fine-strand with wire end ferrule	0.2-4 mm ² (22-12 AWG) 0.2-2.5 mm ² (22-12 AWG)	
Max. tightening torque	0.6 Nm		
Environmental data			
Ambient temperature range	operation storage	-25...+55 °C, cold acc. to IEC 60068-2-1, heat acc. to IEC 60068-2-2 -40...+70 °C	
LCD-Display (clearly legible)	0...+55 °C		
Condensation	avoid condensation with suitable methods		
Humidity, no condensation (IEC/EN 60068-2-30)	5-95 %		
Air pressure (operation)	795-1080 hPa		
Degree of protection (IEC/EN 60529)	IP20		
Vibration (IEC/EN 60068-2-6)	10-57 Hz (constant amplitude 0.15 mm), 57-150 Hz (constant acceleration 2 g)		
Shock resistance (half-sine 15 g / 11 ms) (IEC/EN 60068-2-27)	18 Shocks		
Drop (IEC/EN 60068-2-31) height of fall	50 mm		
Free fall, packaged (IEC/EN 60068-2-32)	1 m		
Insulation data			
Overvoltage category	II		
Pollution degree (DIN EN 60947)	2		
Rating of air and creepage distances	EN 50178, UL 508, CSA C22.2, No. 142		
Insulation resistance	EN 50178		
Standards			
Standards and directives	EN 55011, EN 55022, IEC/EN 61000-4, IEC 60068-2-6, IEC 60068-2-27		
Electromagnetic compatibility			
Interference immunity			
electrostatic discharge (ESD)	IEC/EN 61000-4-2	Level 3 (air discharge 8 kV, contact discharge 6 kV)	
electromag. field (HF radiation resistance)	IEC/EN 61000-4-3	10 V/m	
fast transients (Burst)	IEC/EN 61000-4-4	Level 3 (supply cable 2 kV, signal lines 2 kV)	
powerful impulses (Surge)	IEC/EN 61000-4-5	supply cable symmetrical (AC) 2 kV, Level 2 (supply cable symmetrical (DC) 0.5 kV)	
HF line emission	IEC/EN 61000-4-6	10 V	
Interference suppression (EN 55011, EN 55022)	class B		
Real time clock			
Back-up time	see diagram		-
Accuracy	typ. ±5 (±0.5 h/year)		-
Repeat accuracy of the time relay			
Accuracy (from value)	±1		-
Resolution	range „S“	10 ms	-
	range „M: S“	1 s	-
	range „H: M“	1 min	-
Retention behaviour			
Write cycles of retention memory (minimum)	1.000.000 (10 ⁶)		-

Technical diagram

Back-up time of the real time clock

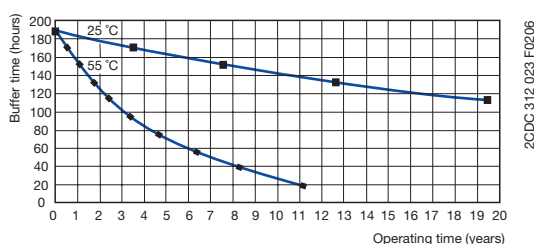

Logic relays

Technical data

Data at T_a = 25 °C and rated values, if nothing else indicated.

Type	CL-LDD...	
Input circuit - Supply circuit		
Power failure buffering (IEC/EN 61131-2)	10 ms	
General data		
Dimensions (W x H x D)	with keypad: 86.5 x 86.5 x 21.5 mm (3.41 x 3.41 x 0.85 inch) without keypad: 86.5 x 86.5 x 20 mm (3.41 x 3.41 x 0.79 inch)	
Weight	0.13 kg (0.29 lb)	
Mounting	2 x 22.5 mm, with 2 retainers screwed	
Mounting position	horizontal / vertical	
Environmental data		
Ambient temperature range	operation	-25...+55 °C (cold acc. to IEC 60068-2-1, heat acc. to IEC 60068-2-2)
	storage	-40...+70 °C
LCD-Display (clearly legible)	-5...+50 °C, -10...0 °C (with backlit / continuous operation)	
Condensation	avoid condensation with suitable methods	
Humidity, no condensation (IEC/EN 60068-2-30)	5-95 %	
Air pressure (operation)	795-1080 hPa	
Degree of protection (IEC/EN 60529)	IP65	
Vibration (IEC/EN 60068-2-6)	10-57 Hz (constant amplitude 0.15 mm), 57-150 Hz (constant acceleration 2 g)	
Shock resistance (half-sine 15 g / 11 ms) (IEC/EN 60068-2-27)	18 Shocks	
Drop (IEC/EN 60068-2-31) height of fall	50 mm	
Free fall, packaged (IEC/EN 60068-2-32)	1 m	
Insulation data		
Pollution degree (DIN EN 60947)	3	
Rating of air and creepage distances	EN 50178, UL 508, CSA 22.2, No. 142	
Insulation resistance	EN 50178	
Standards		
Standards and directives	EN 61000-6-1, EN 61000-6-2, EN 61000-6-3, EN 61000-6-4, IEC 60068-2-6, IEC 60068-2-27	
Electromagnetic compatibility		
Interference immunity		
electrostatic discharge (ESD)	IEC/EN 61000-4-2	Level 3 (air discharge 8 kV, contact discharge 6 kV)
electromag. field (HF radiation resistance)	IEC/EN 61000-4-3	10 V/m
fast transients (Burst)	IEC/EN 61000-4-4	Level 3 (supply cable 2 kV, signal lines 2 kV)
powerful impulses (Surge)	IEC/EN 61000-4-5	Level 3 (supply cable symmetrical 2 kV, CL-LDC.L...AC2) Level 2 (0.5 kV supply cable symmetrical, CL-LDC.L...AC2)
HF line emission	IEC/EN 61000-4-6	10 V
Interference suppression (EN 55011, EN 55022)	class B	

Logic relays

Technical data

Data at $T_a = 25\text{ °C}$ and rated values, if nothing else indicated.

Type	CL-LDC.SDC2	CL-LDC.SAC2	CL-LDC.LDC2	CL-LDC.LAC2	CL-LDC.LNDC2	CL-LDC.LNAC2
Input circuit - Supply circuit						
Rated operational voltage U_o	24 V DC	100-240 V AC	24 V DC	100-240 V AC	24 V DC	100-240 V AC
Rated operational voltage tolerance	-15...+20 %	-15...+10 %	-15...+20 %	-15...+10 %	-15...+20 %	-15...+10 %
Operational voltage range	20.4-28.8 V DC	85-264 V AC	20.4-28.8 V DC	85-264 V AC	20.4-28.8 V DC	85-264 V AC
Frequency	0 Hz	50/60 Hz	0 Hz	50/60 Hz	0 Hz	50/60 Hz
Frequency tolerance	-	± 5 %	-	± 5 %	-	± 5 %
Residual ripple	≤ 5 %	-	≤ 5 %	-	≤ 5 %	-
Input current	at 24 V DC typ. 185 mA	-	at 24 V DC typ. 200 mA	-	at 24 V DC typ. 200 mA	-
	at 115/120 V AC (60 Hz)	typ. 90 mA	-	typ. 90 mA	-	typ. 90 mA
	at 230/240 V AC (50 Hz)	typ. 60 mA	-	typ. 60 mA	-	typ. 60 mA
Power failure buffering (IEC/EN 61131-2)	10 ms	-	3.4 W	-	3.4 W	-
Power dissipation	at 24 V DC 1.5 W	-	at 115/120 V AC typ. 11 VA	-	at 115/120 V AC typ. 11 VA	-
	at 230/240 V AC	typ. 15 VA	-	at 230/240 V AC typ. 15 VA	-	at 230/240 V AC typ. 15 VA
Network - point-to-point connection						
Number of stations	CL-LS..., CL-LM...	1	-	-	-	-
Data transfer rate	CL-LDD	9.6 kBaud	-	-	-	-
		19.2 kBaud	-	-	-	-
Distance		max. 5 m	-	-	-	-
Electrical isolation	to voltage supply	yes	-	-	-	-
	to connected device	yes	-	-	-	-
Termination system		spring-type terminal	-	-	-	-
Network - CL-NET						
Number of stations		max. 1	-	-	max. 8	-
Data transfer rate	6 m	-	-	-	1000 kBit/s	-
	25 m	-	-	-	500 kBit/s	-
	40 m	-	-	-	250 kBit/s	-
	125 m	-	-	-	125 kBit/s	-
	300 m	-	-	-	50 kBit/s	-
	700 m	-	-	-	20 kBit/s	-
	1000 m	-	-	-	10 kBit/s	-
Electrical isolation	to voltage supply	-	-	-	yes	-
	to inputs	-	-	-	yes	-
	to outputs	-	-	-	yes	-
	to PC interface, memory module, CL-NET, CL-LINK	-	-	-	yes	-
Bus terminator (first and last station)		-	-	-	yes	-
Termination system		-	-	-	RJ45, 8 pole	-
General data						
Dimensions (W x H x D)		75 x 58 x 36.2 mm (2.95 x 2.28 x 1.43 inch)		107.5 x 90 x 30 mm (4.23 x 3.54 x 1.18 inch)		
Weight		0.164 kg (0.36 lb)		0.145 kg (0.32 lb)		
Mounting		plugged onto CL-LDD		plugged onto CL-LDD or on DIN rail (IEC/EN 60715)		
Mounting position						
Electrical connection - Supply circuit						
Wire size	fine-strand with wire end ferrule	0.2 mm ² / 2.5 mm ² (24-12 AWG)				
	rigid	0.2 mm ² / 4 mm ² (24-12 AWG)				
Electrical connection - Data cable						
Wire size	fine-strand with wire end ferrule	0.08 mm ² / 1.5 mm ² (28-12 AWG)	-		0.2 mm ² / 2.5 mm ² (24-12 AWG)	
	rigid	0.08 mm ² / 2.5 mm ² (28-12 AWG)	-		0.2 mm ² / 4 mm ² (24-12 AWG)	
Environmental data						
Ambient temperature range	operation	-25...+55 °C (cold acc. to IEC 60068-2-1, heat acc. to IEC 60068-2-2)				
	storage	-40...+70 °C				
Condensation		avoid condensation with suitable methods				
Humidity, no condensation (IEC/EN 60068-2-30)		5-95 %				
Air pressure (operation)		795-1080 hPa				
Degree of protection (IEC/EN 60529)		IP20				
Vibration (IEC/EN 60068-2-6)		10-57 Hz (constant amplitude 0.15 mm), 57-150 Hz (constant acceleration 2 g)				

Logic relays

Technical data

Data at $T_a = 25\text{ °C}$ and rated values, if nothing else indicated.

Type	CL-LDC. SDC2	CL-LDC. SAC2	CL-LDC. LDC2	CL-LDC. LAC2	CL-LDC. LNDC2	CL-LDC. LNAC2
Shock (half-sine 15 g / 11 ms) (IEC/EN 60068-2-27)	18 Shocks					
Drop (IEC/EN 60068-2-31) height of fall	50 mm					
Free fall, packaged (IEC/EN 60068-2-32)	1 m					
Insulation data						
Degree of protection (DIN EN 60947)	2					
Rating of air and creepage distances	EN 50178, UL 508, CSA 22.2, No 142					
Isolation resistance	EN 50178					
Standards						
Standards and directives	EN 61000-6-1, EN 61000-6-2, EN 61000-6-3, EN 61000-6-4, IEC 60068-2-6, IEC 60068-2-27					
Electromagnetical compatibility						
Interference immunity						
electrostatic discharge (ESD)	IEC/EN 61000-4-2	Level 3 (air discharge 8 kV, contact discharge 6 kV)				
electromag. field (HF radiation resistance)	IEC/EN 61000-4-3	10 V/m				
fast transients (Burst)	IEC/EN 61000-4-4	Level 3 (supply cable 2 kV, signal lines 2 kV)				
powerful impulses (Surge)	IEC/EN 61000-4-5	Level 3 (supply cable symmetrical 2 kV, CL-LDC.L...AC2)				
		Level 2 (1 kV supply cable symmetrical)		Level 2 (0.5 kV supply cable symmetrical, CL-LDC.L...AC2)		
HF line emission	IEC/EN 61000-4-6	10 V				
Interference suppression (EN 55011, EN 55022)	class B					
Real time clock						
Back-up time	-		see diagram			
Accuracy	-		typ. ± 5 s/day ($\pm 0,5$ h/year)			
Repeat accuracy of the time relay						
Accuracy (from value)	-		$\pm 0.02\%$			
Resolution	range „S“		5 ms			
	range „M:S“		1 s			
	range „H:M“		1 min			
Retention behaviour						
Write cycles of retention memory (minimum)	-		10^{10} (read/ write cycles)			

6

Technical diagram

Back-up time of the real time clock

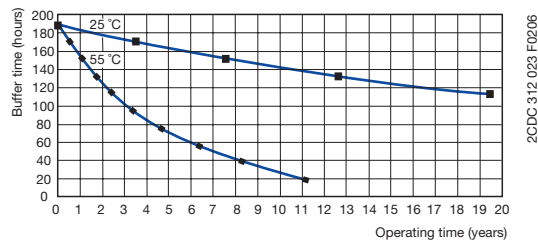

Logic relays

Technical data

Data at $T_a = 25\text{ °C}$ and rated values, if nothing else indicated.

Type	CL-LD...16DC2	CL-LD...17DC2	CL-LDR.16AC2
Input circuit - Digital inputs	24 V DC		115/230 V
Number	12		
Inputs can be used as analog inputs	4 (I7, I8, I11, I12)		
Indication of operational states	-		
Electrical isolation	from supply voltage	no	LCD-Display (if existing)
	from digital inputs	no	
	from the outputs	yes	
	from PC interface, memory module, CL-NET, CL-LINK	yes	
Rated operational voltage U_e	24 V DC		
	U_e on „0“ signal	< 5 V DC (I1-I6, I9, I10), < 8 V DC (I7, I8, I11, I12)	0-40 V AC (sinusoidal)
	U_e on „1“ signal	> 15 V DC (I1-I6, I9, I10), > 8 V DC (I7, I8, I11, I12)	79-264 V AC (sinusoidal)
Rated frequency	0 Hz		
Input current on „1“ signal	3.3 mA (at 24 V DC, I1-I6, I9, I10), 2.2 mA (at 24 V DC, I7, I8, I11, I12)		12x0.2 mA (at 115 V AC, 60 Hz, I1-I12), 12x0.5 mA (at 230 V AC, 50 Hz, I1-I12)
Time delay from „0“ to „1“	debounce ON	20 ms	10 ms (at 50 Hz), 100 ms (at 60 Hz)
	debounce OFF	typ. 0.1 ms (I1-I4), typ. 0.25 ms (I5-I12)	10 ms (at 50 Hz), 100 ms (at 60 Hz)
Time delay from „1“ to „0“	debounce ON	20 ms	10 ms (at 50 Hz), 100 ms (at 60 Hz)
	debounce OFF	typ. 0.1 ms (I1-I4), typ. 0.4 ms (I5, I6, I9, I10), typ. 0.2 ms (I7, I8, I11, I12)	10 ms (at 50 Hz), 100 ms (at 60 Hz)
Cable length (unshielded)	100 m		
Maximum cable length per input	-		
Frequency counter	number	4 (I1, I2, I3, I4)	typ. 60 m
	counting frequency	< 3 kHz	-
	pulse shape	square-wave	-
	pulse / pause ratio	1:1	-
Incremental counter	number	2 (I1 + I2, I3 + I4)	-
	counting frequency	< 3 kHz	-
	pulse shape	square-wave	-
	signal offset	90°	-
	pulse / pause ratio	1:1	-
Rapid counter inputs	number	4 (I1, I2, I3, I4)	-
	counting frequency	< 3 kHz	-
	pulse shape	square-wave	-
	pulse / pause ratio	1:1	-
Cable length (shielded)	< 20 m		
Input circuit - Analog inputs			
Number	4 (I7, I8, I11, I12)		
Electrical isolation	to voltage supply	no	-
	to digital inputs	no	-
	to outputs	yes	-
	to PC interface, memory modul, CL-NET, CL-LINK	yes	-
Input type	DC voltage		
Signal range	0-10 V DC		
Resolution	analog	0.01 V	-
	digital	0.01 V; 10 Bit (value 0-1023)	-
Input impedance	11.2 k Ω		
Accuracy of the actual value	two CL-LD... devices	$\pm 3\%$	-
	within one device	$\pm 2\%$	-
Conversion time analog/digital	each cycle		
Input current	< 1 mA		
Cable length (shielded)	< 30 m		

Logic relays

Technical data

Data at T_a = 25 °C and rated values, if nothing else indicated.

Type		CL-LD...16DC2	CL-LD...17DC2	CL-LDR.16AC2
Output circuit - Analog outputs				
Number		-	1	-
Electrical separation	from voltage supply	-	no	-
	from the digital inputs	-	no	-
	from the digital outputs	-	yes	-
	from PC interface, memory module, CL-NET, CL-LINK	-	yes	-
Output type		-	DC voltage	-
Signal range		-	0-10 V DC	-
Max. output current		-	0.01 A	-
Burden resistance		-	1 kΩ	-
Overload and short-circuit protection		-	yes	-
Resolution	analog	-	0.01 V DC	-
	digital	-	10 Bit, (value: 0-1023)	-
Setting time		-	100 ms	-
Accuracy	-25...+55 °C	-	2 %	-
	25 °C	-	1 %	-
Conversion time		-	each CPU cycle	-
General data				
Dimensions (W x H x D)		CL-LDR: 89 x 90 x 44 mm (3.5 x 3.54 x 1.73 inch) CL-LDT (build-in): 89 x 90 x 25 mm (3.5 x 3.54 x 0.98 inch)		89 x 90 x 44 mm (3.5 x 3.54 x 1.73 inch)
Weight		CL-LDR: 0.15 kg (0.33 lb) / CL-LDT: 0.14 kg (0.31 lb)		0.15 kg (0.33 lb)
Mounting		snap-on power supply unit		
Mounting position		horizontal / vertical		
Electrical connection				
Wire size	fine-strand with wire end ferrule	0.2 mm ² / 2.5 mm ² (24-12 AWG)		
	rigid	0.2 mm ² / 4 mm ² (24-12 AWG)		
Electrical connection - Data cable				
Wire size	fine-strand with wire end ferrule	0.08 mm ² / 1.5 mm ² (28-12 AWG)		
	rigid	0.08 mm ² / 2.5 mm ² (28-12 AWG)		
Environmental data				
Ambient temperature range	operation	-25...+55 °C (cold acc. to IEC 60068-2-1, heat acc. to IEC 60068-2-2)		
	storage	-40...+70 °C		
Condensation		avoid condensation with suitable methods		
Humidity, no condensation (IEC/EN 60068-2-30)		5-95 %		
Atmospheric pressure (operation)		795-1080 hPa		
Degree of protection (IEC/EN 60529)		IP20		
Vibration (IEC/EN 60068-2-6)		10-57 Hz (constant amplitude 0.15 mm), 57-150 Hz (constant acceleration 2 g)		
Shock (half-sine 15 g / 11 ms) (IEC/EN 60068-2-27)		18 Shocks		
Drop (IEC/EN 60068-2-31) height of fall		50 mm		
Free fall, packaged (IEC/EN 60068-2-32)		1 m		
Insulation data				
Pollution degree		2		
Rating of air and creepage distances		EN 50178, UL 508, CSA C22.2, No. 142		
Isolation resistance		EN 50178		
Standards				
Standards and directives		EN 61000-6-1/-2/-3/-4, IEC/EN 61000-4, IEC 60068-2-6, IEC 60068-2-27		
Electromagnetic compatibility				
electrostatic discharge (ESD)	IEC/EN 61000-4-2	Level 3 (air discharge 8 kV, contact discharge 6 kV)		
electromag. field (HF radiation res.)	IEC/EN 61000-4-3	10 V/m		
fast transients (Burst)	IEC/EN 61000-4-4	Level 3 (supply cable 2 kV, signal cable 2 kV)		
powerful impulses (Surge)	IEC/EN 61000-4-5	2 kV (supply cable symmetrical), Level 2 (0.5 kV supply cable symmetrical)		
HF line emission	IEC/EN 61000-4-6	10 V		
Interference suppression (EN 55011, EN 55022)		class B		

Logic relays

Technical data

Data at $T_a = 25\text{ °C}$ and rated values, if nothing else indicated.

Type	CL-LDR...	
Output circuit - Relay outputs		
Number	4	
Outputs in groups of	-	
Parallel switching of outputs to increase capacity	not permissible	
Fusing of the output relay	circuit-breaker B16 or fuse 8 A (slow-acting)	
Electrical isolation	from voltage supply	yes
	from the inputs	yes
	from PC interface, memory module, CL-NET, CL-LINK	yes
	protective separation	300 V AC
	Basic isolation	600 V AC
Mechanical lifetime	10×10^6 switching cycles	
Rung	conventional thermal current (10 A UL)	8 A
	recommended load 12 V AC/DC	> 500 mA
	short-circuit proof $\cos \varphi = 1$; characteristic B16 at 600 A	16 A
	short-circuit proof $\cos \varphi = 0.5$ up to 0.7; characteristic B16 at 900 A	16 A
	Rated impulse withstand voltage U_{imp} contact-coil	6 kV
	Rated operational voltage U_e	250 V AC
Rated insulation voltage U_i	250 V AC	
Protective separation (EN 50178)	between coil and contact	300 V AC
	between two contacts	300 V AC
Making capacity	AC-15, 250 V AC, 3 A (600 ops./h)	300.000 switching cycles
Breaking capacity	DC13, L/R ≤ 150 ms, 24 V DC, 1 A (500 ops./h)	200.000 switching cycles
	AC-15, 250 V AC, 3 A (600 ops./h)	300.000 switching cycles
Incandescent lamp load	DC13, L/R ≤ 150 ms, 24 V DC, 1 A (500 ops./h)	200.000 switching cycles
	1000 W at 230/240 V AC	25.000 switching cycles
Fluorescent lamp load	500 W at 115/120 V AC	25.000 switching cycles
	10 x 58 W at 230/240 V AC with electrical control gear	25.000 switching cycles
	10 x 58 W at 230/240 V AC uncompensated	25.000 switching cycles
	1 x 58 W at 230/240 V AC conventional compensated	25.000 switching cycles
	mechanical operations	10×10^6
Switching frequency	switching frequency	10 Hz
	resistive load / lamp load	2 Hz
	inductive load	0.5 Hz
UL/CSA		
Continuous current at 240 V	10 A AC	
Continuous current at 24 V	8 A DC	
AC	Utilization category (Control Circuit Rating Codes)	B 300 Light Pilot Duty
	max. rated operational voltage	300 V AC
	max. continuous thermal current $\cos \varphi = 1$ at B 300	5 A
	max. making / breaking apparent power (Make/Break) $\cos \varphi \neq 1$ at B 300	3600/360 VA
DC	Utilization category (Control Circuit Rating Codes)	R 300 Light Pilot Duty
	max. rated operational voltage	300 V DC
	max. continuous thermal current at R 300	1 A
	max. making / breaking apparent power (Make/Break) at R 300	28/28 VA

Logic relays

Technical data

Data at $T_a = 25\text{ °C}$ and rated values, if nothing else indicated.

Type	CL-LDT...
Output circuit - Transistor outputs	
Number	4
Rated operational voltage U_o	24 V DC
Operational voltage range	20.4-28.8 V DC
Residual ripple	-
Supply current	on „0“ signal typ. 18 mA / max. 32 mA on „1“ signal typ. 24 mA / max. 44 mA
Reverse voltage protection	yes (Attention: If supply voltage is reversed, applying voltage at the outputs, causes a short circuit.)
Electrical isolation	from voltage supply yes from the inputs yes from PC interface, memory module, CL-NET, CL-LINK yes
Rated operational current I_o on „1“ signal DC	max. 0.5 A
Lamp load without R_v	5 W (Q1-Q4)
Residual current on „0“ signal per channel	< 0.1 mA
Max. output voltage	on „0“ signal at external load < 10 M Ω 2.5 V on „1“ signal at $I_o = 0.5\text{ A}$ $U = U_o - 1\text{ V}$
Short-circuit protection	thermal (Q1-Q4), (analysis results from diagnosis input I16)
Short-circuit tripping current for $R_a \leq 10\text{ m}\Omega$	$0.7\text{ A} \leq I_e \leq 2\text{ A}$ per output
Total short-circuit current	8 A
Peak short-circuit current	16 A
Thermal tripping	yes
Max. switching frequency with constant resistive load $R_L < 100\text{ k}\Omega$ (depending on active channels and their load)	40.000 switching cycles/h
Parallel connection of outputs	with resistive load, inductive load with external suppressor, combination within one group group 1: Q1-Q4 number of outputs max. 4 max. total current 2 A (Attention! Outputs must be actuated simultaneously and for the same length of time.)
Indication of operational states of the outputs	LCD-Display (if existing)
Inductive load ¹⁾ without external suppressor	
$T_{0.95} = 1\text{ ms}$, $R = 48\ \Omega$, $L = 16\text{ mH}$	utilization factor 0.25 g duty time 100 % max. switching frequency $f = 0.5\text{ Hz}$ 1500 switching cycles (max. duty time = 50 %)
DC13, $T_{0.95} = 72\text{ ms}$, $R = 48\ \Omega$, $L = 1.15\text{ H}$	utilization factor 0.25 g duty time 100 % max. switching frequency $f = 0.5\text{ Hz}$ 1500 switching cycles (max. duty time = 50 %)
$T_{0.95} = 15\text{ ms}$, $R = 48\ \Omega$, $L = 0.24\text{ H}$	utilization factor 0.25 g duty time 100 % max. switching frequency $f = 0.5\text{ Hz}$ 1500 switching cycles (max. duty time = 50 %)
Inductive load ¹⁾ with external suppressor	
	demand factor 1 g duty time 100 % max. switching frequency max. duty time depends on suppressor

¹⁾ For inductive loading, without external suppression of the transistor outputs, the following applies:

$T_{0.95}$ = time in ms, until 95 % of the steady-state current is achieved. $T_{0.95} \cdot 3 \times T_{0.65} = 3 \times L/R$.

Data transfer rate in the CL-NET network: bus lengths of 40 m and over only attainable with cables with additional cross-section and connection adapter.

Logic relays

Dimensional drawings

Dimensional drawings

dimensions in mm

CL-LSR, CL-LST

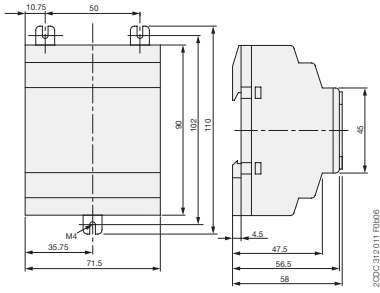

CL-LMR, CL-LMT

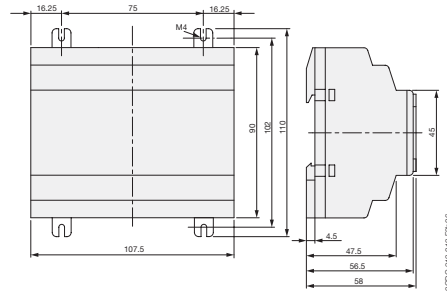

CL-LER.20

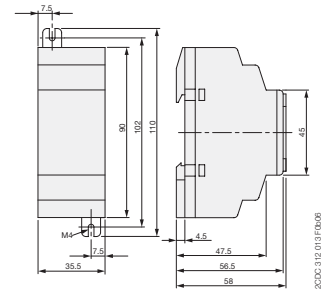

CL-LDD

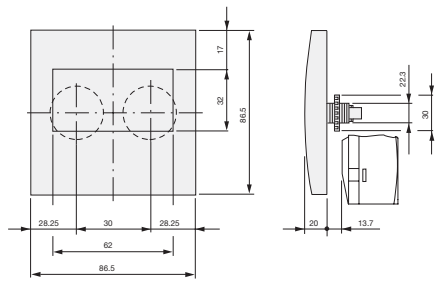

CL-LDD.K + CL-LDC.L.. +
(CL-LDR or CL-LDT)

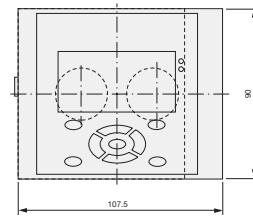

CL-LDC.S..

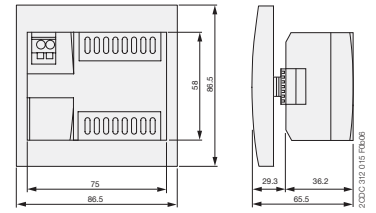

CL-LDR, CL-LDT

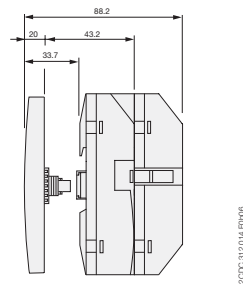
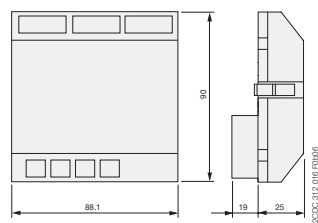

Index

Alphanumerical

Type	Page	Type	Page	Type	Page	Type	Page
Numbers		CC-E IDC/I	258	CC-U/I	267	CL-LMR.CX18DC1	331
		CC-E IDC/I	259	CC-U/RTD	267	CL-LMR.CX18DC2	331
A		CC-E IDC/I	259	CC-U/RTD	267	CL-LMT.C20DC2	331
ADP.01	39	CC-E IDC/V	258	CC-U/STD	267	CL-LMT.CX20DC2	331
ADP.01	39	CC-E IDC/V	259	CC-U/STD	267	CL-LSR.12AC2	330
ADP.01	176	CC-E RTD/I	257	CC-U/STDR	267	CL-LSR.12DC2	330
ADP.01	268	CC-E RTD/I	257	CC-U/STDR	267	CL-LSR.C12AC1	330
ADP.02	176	CC-E RTD/I	257	CC-U/TC	267	CL-LSR.C12AC2	330
		CC-E RTD/I	257	CC-U/TC	267	CL-LSR.C12DC1	330
B		CC-E RTD/I	257	CC-U/TCR	267	CL-LSR.C12DC2	330
BJ612-10	312	CC-E RTD/I	257	CC-U/TCR	267	CL-LSR.CX12AC1	330
BJ612-10	320	CC-E RTD/I	257	CC-U/V	267	CL-LSR.CX12AC2	330
BJ612-20	312	CC-E RTD/I	257	CC-U/V	267	CL-LSR.CX12DC1	330
BJ612-20	320	CC-E RTD/I	257	CL-LAD.FD001	333	CL-LSR.CX12DC2	330
		CC-E RTD/I	257	CL-LAD.FD002	333	CL-LST.C12DC2	330
C		CC-E RTD/I	257	CL-LAD.FD011	333	CL-LST.CX12DC2	330
C011-100	140	CC-E RTD/I	257	CL-LAD.MD004	333	CM-AH-3	166
C011-110	140	CC-E RTD/I	257	CL-LAD.TK001	333	CM-CT 100/1	177
C011-120	140	CC-E RTD/I	257	CL-LAD.TK002	333	CM-CT 100/5	177
C011-130	140	CC-E RTD/I	257	CL-LAD.TK003	333	CM-CT 150/1	177
C011-140	140	CC-E RTD/I	257	CL-LAD.TK004	333	CM-CT 150/5	177
C011-150	140	CC-E RTD/V	257	CL-LAD.TK005	333	CM-CT 200/1	177
C011-160	140	CC-E RTD/V	257	CL-LAD.TK006	333	CM-CT 200/5	177
C011-170	140	CC-E RTD/V	257	CL-LAD.TK007	332	CM-CT 300/1	177
C011-3-150	140	CC-E RTD/V	257	CL-LAD.TK009	333	CM-CT 300/5	177
C011-70	140	CC-E RTD/V	257	CL-LAD.TK011	333	CM-CT 400/1	177
C011-80	140	CC-E RTD/V	257	CL-LAS.FD001	332	CM-CT 400/5	177
C011-90	140	CC-E RTD/V	257	CL-LAS.MD003	332	CM-CT 50/1	177
C512-24	154	CC-E RTD/V	257	CL-LAS.PS002	332	CM-CT 50/5	177
C512-D	154	CC-E TC/I	258	CL-LAS.TK001	332	CM-CT 500/1	177
C512-E	154	CC-E TC/I	258	CL-LAS.TK002	332	CM-CT 500/5	177
C512-W	154	CC-E TC/I	258	CL-LAS.TK011	332	CM-CT 600/1	177
C513-D	154	CC-E TC/I	258	CL-LDC.LAG2	333	CM-CT 600/5	177
C513-E	154	CC-E TC/I	258	CL-LDC.LDC2	333	CM-CT 75/1	177
C513-W	154	CC-E TC/I	258	CL-LDC.LNAC2	333	CM-CT 75/5	177
CC-E I/I	256	CC-E TC/I	258	CL-LDC.LNDC2	333	CM-CT A	177
CC-E I/I	256	CC-E TC/I	258	CL-LDC.SAC2	330	CM-EFS.2P	66
CC-E I/I	256	CC-E TC/V	258	CL-LDC.SDC2	330	CM-EFS.2S	66
CC-E I/I	256	CC-E TC/V	258	CL-LDD.K	330	CM-ENE MAX	166
CC-E I/I	256	CC-E TC/V	258	CL-LDD.K	333	CM-ENE MAX	166
CC-E I/I	256	CC-E TC/V	258	CL-LDD.XK	330	CM-ENE MAX	166
CC-E I/I	256	CC-E V/I	256	CL-LDD.XK	333	CM-ENE MIN	166
CC-E I/I-1	256	CC-E V/I	256	CL-LDR.16AC2	333	CM-ENE MIN	166
CC-E I/I-2	256	CC-E V/I	256	CL-LDR.16DC2	333	CM-ENE MIN	166
CC-E I/V	256	CC-E V/V	256	CL-LDR.17DC2	333	CM-ENS.11P	166
CC-E I/V	256	CC-E V/V	256	CL-LDT.16DC2	333	CM-ENS.11S	166
CC-E I/V	256	CC-E V/V	256	CL-LDT.17DC2	333	CM-ENS.13P	166
CC-E I/V	256	CC-E V/V	256	CL-LEC.CI000	331	CM-ENS.13S	166
CC-E I/V	256	CC-E V/V	256	CL-LER.18AC2	331	CM-ENS.21P	166
CC-E IAC/I	258	CC-E/I	259	CL-LER.18DC2	331	CM-ENS.21S	166
CC-E IAC/I	258	CC-E(I1)	258	CL-LER.20	331	CM-ENS.23P	166
CC-E IAC/I	259	CC-E/RTD	257	CL-LET.20DC2	331	CM-ENS.23S	166
CC-E IAC/I	259	CC-E/RTD	257	CL-LMR.C18AC1	331	CM-ENS.31P	166
CC-E IAC/ILPO	259	CC-E/STD	256	CL-LMR.C18AC2	331	CM-ENS.31S	166
CC-E IAC/V	258	CC-E/STD	256	CL-LMR.C18DC1	331	CM-ESS.1P	66
CC-E IAC/V	259	CC-E/TC	258	CL-LMR.C18DC2	331	CM-ESS.1P	66
CC-E IDC/I	258	CC-E/TC1)	258	CL-LMR.CX18AC1	331	CM-ESS.1P	66
		CC-U/I	267	CL-LMR.CX18AC2	331	CM-ESS.1S	66

Index

Alphanumerical

Type	Page	Type	Page	Type	Page	Type	Page
CM-ESS.1S	66	CM-MSE	140	CM-SRS.12S	64	CP-E 24/10.0	198
CM-ESS.1S	66	CM-MSE	140	CM-SRS.12S	64	CP-E 24/2.5	198
CM-ESS.2P	66	CM-MSS.11P	140	CM-SRS.12S	64	CP-E 24/20.0	198
CM-ESS.2P	66	CM-MSS.11S	140	CM-SRS.21P	64	CP-E 24/5.0	198
CM-ESS.2P	66	CM-MSS.12P	140	CM-SRS.21P	64	CP-E 48/0.62	198
CM-ESS.2S	66	CM-MSS.12S	140	CM-SRS.21P	64	CP-E 48/1.25	198
CM-ESS.2S	66	CM-MSS.13P	140	CM-SRS.21S	64	CP-E 48/10.0	198
CM-ESS.2S	66	CM-MSS.13S	140	CM-SRS.21S	64	CP-E 48/5.0	198
CM-ESS.MP	66	CM-MSS.21P	140	CM-SRS.21S	64	CP-E 5/3.0	198
CM-ESS.MS	66	CM-MSS.21S	140	CM-SRS.22S	64	CP-RUD	229
CM-GM-1	166	CM-MSS.22P	140	CM-SRS.22S	64	CP-T 24/10.0	212
CM-HC	166	CM-MSS.22S	140	CM-SRS.22S	64	CP-T 24/20.0	212
CM-HCT	166	CM-MSS.23P	140	CM-SRS.M1P	64	CP-T 24/40.0	212
CM-HE	166	CM-MSS.23S	140	CM-SRS.M1S	64	CP-T 24/5.0	212
CM-IVN.P	116	CM-MSS.31P	140	CM-SRS.M2S	64	CP-T 48/10.0	212
CM-IVN.S	116	CM-MSS.31S	140	CM-TCS.11P	154	CP-T 48/20.0	212
CM-IWN.1P	116	CM-MSS.32P	140	CM-TCS.11S	154	CP-T 48/5.0	212
CM-IWN.1S	116	CM-MSS.32S	140	CM-TCS.12P	154	CR-M012DC2	288
CM-IWN.4P	116	CM-MSS.33P	140	CM-TCS.12S	154	CR-M012DC2L	289
CM-IWN.4S	116	CM-MSS.33S	140	CM-TCS.13P	154	CR-M012DC3	288
CM-IWN.5P	116	CM-MSS.41P	140	CM-TCS.13S	154	CR-M012DC3L	289
CM-IWN.5S	116	CM-MSS.41S	140	CM-TCS.21P	154	CR-M012DC4	288
CM-IWN.6P	116	CM-MSS.51P	140	CM-TCS.21S	154	CR-M012DC4L	289
CM-IWN.6S	116	CM-MSS.51S	140	CM-TCS.22P	154	CR-M012DC4LDG	290
CM-IWS.1P	116	CM-PAS.31P	82	CM-TCS.22S	154	CR-M012DC4LG	290
CM-IWS.1S	116	CM-PAS.31S	82	CM-TCS.23P	154	CR-M024AC2	288
CM-IWS.2P	116	CM-PAS.41P	82	CM-TCS.23S	154	CR-M024AC2L	289
CM-IWS.2S	116	CM-PAS.41S	82	CM-UFD.M22	104	CR-M024AC3	288
CM-KH-3	166	CM-PBE	82	CM-UFD.M31	104	CR-M024AC3L	289
CM-LWN	126	CM-PBE	82	CM-UFD.M33	104	CR-M024AC4	288
CM-LWN	126	CM-PFE	82	CM-UFD.M34	104	CR-M024AC4G	289
CM-LWN	126	CM-PFE.2	82	COV.01	39	CR-M024AC4L	289
CM-LWN	126	CM-PFS.P	82	COV.01	176	CR-M024AC4LG	290
CM-LWN	126	CM-PFS.S	82	COV.01	268	CR-M024DC2	288
CM-LWN	126	CM-PSS.31P	82	COV.02	176	CR-M024DC2L	289
CM-LWN	126	CM-PSS.31S	82	COV.11	39	CR-M024DC3	288
CM-LWN	126	CM-PSS.41P	82	COV.11	176	CR-M024DC3L	289
CM-LWN	126	CM-PSS.41S	82	COV.12	176	CR-M024DC4	288
CM-LWN	126	CM-PVE	82	CP-A CM	229	CR-M024DC4G	289
CM-MPN.52P	84	CM-PVE	82	CP-A RU	229	CR-M024DC4L	289
CM-MPN.52S	84	CM-PVS.31P	82	CP-B 24/10.0	238	CR-M024DC4LD	289
CM-MPN.62P	84	CM-PVS.31S	82	CP-B 24/20.0	238	CR-M024DC4LDG	290
CM-MPN.62S	84	CM-PVS.41P	82	CP-B 24/3.0	238	CR-M024DC4LG	290
CM-MPN.72P	84	CM-PVS.41S	82	CP-B EXT.2	238	CR-M048AC2	288
CM-MPN.72S	84	CM-PVS.81P	82	CP-C.1 24/10.0	222	CR-M048AC2L	289
CM-MPS.11P	84	CM-PVS.81S	82	CP-C.1 24/20.0	222	CR-M048AC3	288
CM-MPS.11S	84	CM-SE-1000	166	CP-C.1 24/5.0	222	CR-M048AC3L	289
CM-MPS.21P	84	CM-SE-300	166	CP-D 12/0.83	188	CR-M048AC4	288
CM-MPS.21S	84	CM-SE-600	166	CP-D 12/2.1	188	CR-M048AC4L	289
CM-MPS.23P	84	CM-SFS.21P	64	CP-D 24/0.42	188	CR-M048AC4LG	290
CM-MPS.23S	84	CM-SFS.21S	64	CP-D 24/1.3	188	CR-M048DC2	288
CM-MPS.31P	84	CM-SFS.22S	64	CP-D 24/2.5	188	CR-M048DC2L	289
CM-MPS.31S	84	CM-SRS.11P	64	CP-D 24/4.2	188	CR-M048DC3	288
CM-MPS.41P	84	CM-SRS.11P	64	CP-D RU	229	CR-M048DC3L	289
CM-MPS.41S	84	CM-SRS.11P	64	CP-E 12/10.0	198	CR-M048DC4	288
CM-MPS.43P	84	CM-SRS.11S	64	CP-E 12/2.5	198	CR-M048DC4L	289
CM-MPS.43S	84	CM-SRS.11S	64	CP-E 24/0.75	198	CR-M048DC4LG	290
CM-MSE	140	CM-SRS.11S	64	CP-E 24/1.25	198	CR-M060AC3	288

Index

Alphanumerical

Type	Page	Type	Page	Type	Page	Type	Page
CR-M060DC2	288	CR-M4LS	290	CR-PLSx	287	CR-U 61E	293
CR-M060DC2L	289	CR-M4SF	290	CR-PM	287	CR-U 61EV	293
CR-M060DC3	288	CR-M4SS	290	CR-PSS	287	CR-U 61V	293
CR-M060DC3L	289	CR-MH	290	CR-S005VDC1R	286	CR-U 71	293
CR-M060DC4	288	CR-MH1	290	CR-S005VDC1RG	286	CR-U 71A	293
CR-M060DC4L	289	CR-MJ	290	CR-S006/024VDC1SS	286	CR-U 81	293
CR-M060DC4LG	290	CR-MM	290	CR-S006/024VDC1SZ	286	CR-U 91	293
CR-M110AC2	288	CR-P/M 22	291	CR-S012/024VADC1SS	286	CR-U 91C	293
CR-M110AC2L	289	CR-P/M 42	291	CR-S012/024VADC1SZ	286	CR-U 91CV	293
CR-M110AC3	288	CR-P/M 42B	291	CR-S012VDC1R	286	CR-U 91V	293
CR-M110AC3L	289	CR-P/M 42BV	291	CR-S012VDC1RG	286	CR-U T	293
CR-M110AC4	288	CR-P/M 42C	291	CR-S024VADC1CRGS	286	CR-U012DC2	292
CR-M110AC4G	289	CR-P/M 42CV	291	CR-S024VADC1CRGZ	286	CR-U012DC2L	292
CR-M110AC4L	289	CR-P/M 42V	291	CR-S024VADC1CRS	286	CR-U012DC3	292
CR-M110AC4LG	290	CR-P/M 52B	291	CR-S024VADC1CRZ	286	CR-U012DC3L	292
CR-M110DC2	288	CR-P/M 52C	291	CR-S024VDC1MOS	286	CR-U024AC2	292
CR-M110DC2L	289	CR-P/M 52D	291	CR-S024VDC1R	286	CR-U024AC2L	292
CR-M110DC3	288	CR-P/M 62	291	CR-S024VDC1RG	286	CR-U024AC3	292
CR-M110DC3L	289	CR-P/M 62C	291	CR-S024VDC1TRA	286	CR-U024AC3L	292
CR-M110DC4	288	CR-P/M 62CV	291	CR-S024VDC1TRI	286	CR-U024DC2	292
CR-M110DC4L	289	CR-P/M 62D	291	CR-S048/060VADC1SS	286	CR-U024DC2L	292
CR-M110DC4LG	290	CR-P/M 62DV	291	CR-S048/060VADC1SZ	286	CR-U024DC3	292
CR-M120AC2	288	CR-P/M 62E	291	CR-S048VDC1R	286	CR-U024DC3L	292
CR-M120AC2L	289	CR-P/M 62EV	291	CR-S048VDC1RG	286	CR-U048AC2	292
CR-M120AC3	288	CR-P/M 62V	291	CR-S060VDC1R	286	CR-U048AC2L	292
CR-M120AC3L	289	CR-P/M 72	291	CR-S060VDC1RG	286	CR-U048AC3	292
CR-M120AC4	288	CR-P/M 72A	291	CR-S110/125VADC1SS	286	CR-U048AC3L	292
CR-M120AC4L	289	CR-P/M 82	291	CR-S110/125VADC1SZ	286	CR-U048DC2	292
CR-M120AC4LG	290	CR-P/M 92	291	CR-S110VADC1CRGS	286	CR-U048DC2L	292
CR-M125DC2	288	CR-P/M 92C	291	CR-S110VADC1CRGZ	286	CR-U048DC3	292
CR-M125DC2L	289	CR-P/M 92CV	291	CR-S110VADC1CRS	286	CR-U048DC3L	292
CR-M125DC3	288	CR-P/M 92V	291	CR-S110VADC1CRZ	286	CR-U060AC3	292
CR-M125DC3L	289	CR-P012DC1	287	CR-S220/240VADC1SS	286	CR-U110AC2	292
CR-M125DC4	288	CR-P012DC2	287	CR-S220/240VADC1SZ	286	CR-U110AC2L	292
CR-M125DC4L	289	CR-P024AC1	287	CR-S230VADC1CRGS	286	CR-U110AC3	292
CR-M125DC4LG	290	CR-P024AC2	287	CR-S230VADC1CRGZ	286	CR-U110AC3L	292
CR-M220DC2	288	CR-P024AC2G	287	CR-S230VADC1CRS	286	CR-U110DC2	292
CR-M220DC2L	289	CR-P024DC1	287	CR-S230VADC1CRZ	286	CR-U110DC2L	292
CR-M220DC3	288	CR-P024DC2	287	CR-SJB20-BLACK	286	CR-U110DC3	292
CR-M220DC3L	289	CR-P024DC2	287	CR-SJB20-BLUE	286	CR-U110DC3L	292
CR-M220DC4	288	CR-P048AC1	287	CR-SJB20-RED	286	CR-U120AC2	292
CR-M220DC4L	289	CR-P048AC2	287	CR-SM	286	CR-U120AC2L	292
CR-M220DC4LG	290	CR-P048DC1	287	CR-SSEP	286	CR-U120AC3	292
CR-M230AC2	288	CR-P048DC2	287	CR-U 21	293	CR-U120AC3L	292
CR-M230AC2L	289	CR-P110AC1	287	CR-U 41	293	CR-U125DC3	292
CR-M230AC3	288	CR-P110AC2	287	CR-U 41B	293	CR-U220DC2	292
CR-M230AC3L	289	CR-P110AC2G	287	CR-U 41BV	293	CR-U220DC2L	292
CR-M230AC4	288	CR-P110DC1	287	CR-U 41C	293	CR-U220DC3	292
CR-M230AC4G	289	CR-P110DC2	287	CR-U 41CV	293	CR-U220DC3L	292
CR-M230AC4L	289	CR-P120AC1	287	CR-U 41V	293	CR-U230AC2	292
CR-M230AC4LG	290	CR-P120AC2	287	CR-U 51B	293	CR-U230AC2L	292
CR-M2LC	290	CR-P230AC1	287	CR-U 51C	293	CR-U230AC3	292
CR-M2LS	290	CR-P230AC2	287	CR-U 51D	293	CR-U230AC3L	292
CR-M2SF	290	CR-P230AC2G	287	CR-U 61	293	CR-U2S	292
CR-M2SS	290	CR-PH	287	CR-U 61C	293	CR-U2SM	292
CR-M3LS	290	CR-PJ	287	CR-U 61CV	293	CR-U3E	292
CR-M3SS	290	CR-PLC	287	CR-U 61D	293	CR-U3S	292
CR-M4LC	290	CR-PLS	287	CR-U 61DV	293	CR-U3SM	292

Index

Alphanumerical

Type	Page	Type	Page	Type	Page	Type	Page
CR-UH	292	CT-ERE	26	E		OBROC2000-5-12VDC	320
CT- MXS.22S	37	CT-ERE	27	EPD24-TB-101-0.5A	245	OBROC5000-230VUC	320
CT-AHD.12	18	CT-ERE	27	EPD24-TB-101-10A	245	OBROC5000-24VDC	320
CT-AHD.22	18	CT-ERE	27	EPD24-TB-101-12A	245	R	
CT-AHE	26	CT-ERE	27	EPD24-TB-101-1A	245	RB101R-24VUC	311
CT-AHE	26	CT-ERE	27	EPD24-TB-101-2A	245	RB111-115VUC	311
CT-AHE	26	CT-ERE	27	EPD24-TB-101-3A	245	RB111-230VUC	311
CT-AHE	26	CT-ERE	27	EPD24-TB-101-4A	245	RB111-24VUC	311
CT-AHE	26	CT-ERE	27	EPD24-TB-101-6A	245	RB111R-24VUC	311
CT-AHE	26	CT-ERS.12P	38	EPD24-TB-101-8A	245	RB121-115VUC	311
CT-AHE	26	CT-ERS.12S	38	EPD-BB500	245	RB121-12VDC	311
CT-AHE	26	CT-ERS.21P	38	EPD-SB21	245	RB121-230VUC	311
CT-AHE	26	CT-ERS.21S	38	K		RB121-24VDC	311
CT-AHE	27	CT-ERS.22P	38	KA1-8029	39	RB121-24VUC	311
CT-AHE	27	CT-ERS.22S	38	KA1-8030	39	RB121-48-60VUC	311
CT-AHE	27	CT-MBS.22P	37	M		RB121-60-230VUC	312
CT-AHE	27	CT-MBS.22S	37	MA16-1060	39	RB121G-115VUC	311
CT-AHE	27	CT-MFD.12	18	MAR.01	39	RB121G-12VDC	311
CT-AHE	27	CT-MFD.21	18	MAR.01	39	RB121G-230VUC	311
CT-AHE	27	CT-MFE	26	MAR.01	39	RB121G-24VUC	311
CT-AHE	27	CT-MFE	27	MAR.01	176	RB121G-24VUC	311
CT-AHE	27	CT-MFS.21P	37	MAR.01	268	RB121G-48-60VUC	311
CT-AHS.22P	38	CT-MFS.21S	37	MAR.02	39	RB121P-12VDC	311
CT-AHS.22S	38	CT-MVS.12P	37	MAR.02	176	RB121P-5VDC	311
CT-APS.12P	38	CT-MVS.12S	37	MAR.12	39	RB121PG-5VDC	311
CT-APS.12S	38	CT-MVS.21P	37	MAR.12	176	RB121R-115VUC	312
CT-APS.21P	38	CT-MVS.21S	37	MT-150B	39	RB121R-230VUC	312
CT-APS.21S	38	CT-MVS.22P	37	MT-250B	39	RB122G-115VUC	312
CT-APS.22P	38	CT-MVS.22S	37	MT-350B	39	RB122G-230VUC	312
CT-APS.22S	38	CT-MVS.23P	37	O		RB122G-24VUC	312
CT-ARE	26	CT-MVS.23S	37	OBIC0100-115-230	320	RB122G-48-60VUC	312
CT-ARE	26	CT-MXS.22P	37	OBIC0100-24VDC	320	RBR101R-24VUC	311
CT-ARE	26	CT-SAD.22	18	OBIC0100-48-60VUC	320	RBR111-24VUC	311
CT-ARE	26	CT-SDD.22	18	OBIC0100-5-12VDC	320	RBR111R-24VUC	311
CT-ARE	27	CT-SDS.22P	38	OBOA1000-115VUC	320	RBR121-115VUC	311
CT-ARE	27	CT-SDS.22S	38	OBOA1000-230VUC	320	RBR121-230VUC	311
CT-ARE	27	CT-SDS.23P	38	OBOA1000-24VDC	320	RBR121-24VDC	311
CT-ARE	27	CT-SDS.23S	38	OBOA1000-24VDC	320	RBR121-24VUC	311
CT-ARS.11P	38	CT-TGD.12	18	OBOA2000-24VDC	320	RBR121-48-60VUC	311
CT-ARS.11S	38	CT-TGD.22	18	OBOC2000-115VUC	320	RBR121-60-230VUC	312
CT-ARS.21P	38	CT-VWD.12	18	OBOC2000-230VUC	320	RBR121G-115VUC	311
CT-ARS.21S	38	CT-VWE	26	OBOC2000-24VDC	320	RBR121G-230VUC	311
CT-AWE	26	CT-VWE	26	OBOC2000-24VUC	320	RBR121G-24VDC	311
CT-AWE	26	CT-VWE	26	OBOC2000-48-60VUC	320	RBR121G-24VUC	311
CT-AWE	26	CT-VWE	26	OBOC2000-5-12VDC	320	RBR121G-48-60VUC	311
CT-AWE	27	CT-VWE	26	OBOC5000-115VUC	320	RBR121P-12VDC	311
CT-AWE	27	CT-VWE	27	OBOC5000-24VDC	320	RBR121P-5VDC	311
CT-EBD.12	18	CT-VWE	27	OBRIC0100-115-230	320	RBR121R-230VUC	312
CT-ERD.12	18	CT-VWE	27	OBRIC0100-24VDC	320	RBR122G-115VUC	312
CT-ERD.22	18	CT-VWE	27	OBRIC0100-48-60VUC	320	RBR122G-230VUC	312
CT-ERE	26	CT-VWE	27	OBRIC0100-5-12VDC	320	RBR122G-24VUC	312
CT-ERE	26	CT-VWE	27	OBROA1000-24VDC	320	RBR122G-48-60VUC	312
CT-ERE	26	CT-WBS.22P	37	OBROA2000-24VDC	320	RC610	312
CT-ERE	26	CT-WBS.22S	37	OBROC2000-230VUC	320	RC610	320
CT-ERE	26			OBROC2000-24VDC	320	RC65	312
CT-ERE	26			OBROC2000-24VUC	320	RC65	320
CT-ERE	26			OBROC2000-48-60VUC	320		

Index

Alphanumerical

Type	Page	Type	Page	Type	Page
S					
SC612	312				
SC612	320				
SK 615 562-87	39				
SK 615 562-88	39				

Index Numerical

Order code	Type	Page	Order code	Type	Page	Order code	Type	Page
1SAR			1SNA645051R0400..OB0C2000-24VDC..... 320			1SVR011711R1600..CC-E V/I..... 256		
1SAR700100R0005..C512-24.....		154	1SNA645053R0600..OB0C2000-48-60VUC.....		320	1SVR011712R1700..CC-E V/I.....		256
1SAR700100R0010..C512-W.....		154	1SNA645054R0700..OB0C2000-115VUC.....		320	1SVR011713R1000..CC-E I/V.....		256
1SAR700110R0010..C513-W.....		154	1SNA645058R1300..OB0C5000-115VUC.....		320	1SVR011714R1100..CC-E I/I.....		256
1SFA			1SNA645062R0700..OBOA1000-115VUC.....		320	1SVR011715R1200..CC-E I/I.....		256
1SFA611410R1506..MT-150B.....		39	1SNA645071R0000..RB121-24VDC.....		311	1SVR011716R1300..CC-E I/V.....		256
1SFA611410R2506..MT-250B.....		39	1SNA645072R0000..RB121G-24VDC.....		311	1SVR011717R1400..CC-E I/I.....		256
1SFA611410R3506..MT-350B.....		39	1SNA645073R0000..RB121-12VDC.....		311	1SVR011718R2500..CC-E I/I.....		256
1SFA611940R1060..MA16-1060.....		39	1SNA645075R0000..RB121G-12VDC.....		311	1SVR011719R2600..CC-E V/V.....		256
1SFA616920R8029..KA1-8029.....		39	1SNA645501R0500..RBR121-24VUC.....		311	1SVR011720R2300..CC-E V/V.....		256
1SFA616920R8030..KA1-8030.....		39	1SNA645502R0600..RBR121-48-60VUC.....		311	1SVR011721R1000..CC-E V/I.....		256
1SNA			1SNA645503R0700..RBR121-115VUC.....		311	1SVR011722R1100..CC-E V/I.....		256
1SNA206754R0000..BJ612-20.....		312	1SNA645504R0000..RBR121-230VUC.....		311	1SVR011723R1200..CC-E I/V.....		256
1SNA206754R0000..BJ612-20.....		320	1SNA645505R0100..RBR121G-24VUC.....		311	1SVR011724R1300..CC-E I/I.....		256
1SNA232000R0000..RC65.....		312	1SNA645506R0200..RBR121G-48-60VUC.....		311	1SVR011725R1400..CC-E I/I.....		256
1SNA232000R0000..RC65.....		320	1SNA645507R0300..RBR121G-115VUC.....		311	1SVR011726R1500..CC-E I/V.....		256
1SNA233000R0100..RC610.....		312	1SNA645508R1400..RBR121G-230VUC.....		311	1SVR011727R1600..CC-E I/I.....		256
1SNA233000R0100..RC610.....		320	1SNA645511R2600..RBR121R-230VUC.....		312	1SVR011728R2700..CC-E I/I.....		256
1SNA290474R0200..SC612.....		312	1SNA645512R2700..RBR122G-24VUC.....		312	1SVR011729R2000..CC-E V/V.....		256
1SNA290474R0200..SC612.....		320	1SNA645513R2000..RBR122G-230VUC.....		312	1SVR011730R2500..CC-E RTD/V.....		257
1SNA290488R0100..BJ612-10.....		312	1SNA645514R2100..RBR111-24VUC.....		311	1SVR011731R1200..CC-E RTD/I.....		257
1SNA290488R0100..BJ612-10.....		320	1SNA645518R0500..RBR111R-24VUC.....		311	1SVR011732R1300..CC-E RTD/I.....		257
1SNA645001R0300..RB121-24VUC.....		311	1SNA645519R0600..RBR101R-24VUC.....		311	1SVR011733R1400..CC-E RTD/V.....		257
1SNA645002R0400..RB121-48-60VUC.....		311	1SNA645520R0300..RBR121-60-230VUC.....		312	1SVR011734R1500..CC-E RTD/I.....		257
1SNA645003R0500..RB121-115VUC.....		311	1SNA645521R2000..OBRIC0100-24VDC.....		320	1SVR011735R1600..CC-E RTD/I.....		257
1SNA645004R0400..RB121-230VUC.....		311	1SNA645522R2100..OBRIC0100-115-230.....		320	1SVR011736R1700..CC-E RTD/V.....		257
1SNA645005R0700..RB121G-24VUC.....		311	1SNA645524R2300..OBROC5000-24VDC.....		320	1SVR011737R1000..CC-E RTD/I.....		257
1SNA645006R0000..RB121G-48-60VUC.....		311	1SNA645525R2400..OBROC2000-24VUC.....		320	1SVR011738R2100..CC-E RTD/I.....		257
1SNA645007R0100..RB121G-115VUC.....		311	1SNA645526R2500..OBROC2000-230VUC.....		320	1SVR011739R2200..CC-E RTD/V.....		257
1SNA645008R1200..RB121G-230VUC.....		311	1SNA645527R2600..OBROA1000-24VDC.....		320	1SVR011740R0700..CC-E RTD/I.....		257
1SNA645011R2400..RB121R-230VUC.....		312	1SNA645529R0000..OBROA2000-24VDC.....		320	1SVR011741R2400..CC-E RTD/I.....		257
1SNA645012R2500..RB122G-24VUC.....		312	1SNA645534R2500..RBR121P-5VDC.....		311	1SVR011750R0100..CC-E TC/V.....		258
1SNA645013R2600..RB122G-230VUC.....		312	1SNA645535R2600..RBR121P-12VDC.....		311	1SVR011751R2600..CC-E TC/I.....		258
1SNA645014R2700..RB111-24VUC.....		311	1SNA645540R1700..RBR122G-48-60VUC.....		312	1SVR011752R2700..CC-E TC/I.....		258
1SNA645016R2100..RB111-115VUC.....		311	1SNA645541R0400..RBR122G-115VUC.....		312	1SVR011753R2000..CC-E TC/V.....		258
1SNA645017R2200..RB111-230VUC.....		311	1SNA645547R0200..OBRIC0100-5-12VDC.....		320	1SVR011754R2100..CC-E TC/I.....		258
1SNA645018R0300..RB111R-24VUC.....		311	1SNA645549R1400..OBRIC0100-48-60VUC.....		320	1SVR011755R2200..CC-E TC/I.....		258
1SNA645019R0400..RB101R-24VUC.....		311	1SNA645550R1100..OBROC2000-5-12VDC.....		320	1SVR011760R0300..CC-E TC/V.....		258
1SNA645020R0100..RB121-60-230VUC.....		312	1SNA645551R0600..OBROC2000-24VDC.....		320	1SVR011761R2000..CC-E TC/I.....		258
1SNA645021R2600..OBIC0100-24VDC.....		320	1SNA645553R0000..OBROC2000-48-60VUC.....		320	1SVR011762R2100..CC-E TC/I.....		258
1SNA645022R2700..OBIC0100-115-230.....		320	1SNA645559R1600..OBROC5000-230VUC.....		320	1SVR011763R2200..CC-E TC/V.....		258
1SNA645024R2100..OB0C5000-24VDC.....		320	1SNA645571R0000..RBR121-24VDC.....		311	1SVR011764R2300..CC-E TC/I.....		258
1SNA645025R2200..OB0C2000-24VUC.....		320	1SNA645572R0000..RBR121G-24VDC.....		311	1SVR011765R2400..CC-E TC/I.....		258
1SNA645026R2300..OB0C2000-230VUC.....		320	1SNB041391R0610..CR-SM.....		286	1SVR011770R0500..CC-E IAC/V.....		258
1SNA645027R2400..OBOA1000-24VDC.....		320	1SVR			1SVR011771R2200..CC-E IAC/I.....		258
1SNA645028R0500..OBOA1000-230VUC.....		320	1SVR010200R1600..CC-E I/I-1.....		256	1SVR011772R2300..CC-E IAC/I.....		258
1SNA645029R0600..OBOA2000-24VDC.....		320	1SVR010201R0300..CC-E I/I-2.....		256	1SVR011773R2400..CC-E IDC/V.....		258
1SNA645034R2300..RB121P-5VDC.....		311	1SVR010203R0500..CC-E IAC/ILPO.....		259	1SVR011774R2500..CC-E IDC/I.....		258
1SNA645035R2400..RB121P-12VDC.....		311	1SVR011700R0000..CC-E/STD.....		256	1SVR011775R2600..CC-E IDC/I.....		258
1SNA645036R2500..RB121PG-5VDC.....		311	1SVR011701R2500..CC-E/RTD.....		257	1SVR011780R1100..CC-E IAC/V.....		259
1SNA645040R1500..RB122G-48-60VUC.....		312	1SVR011702R2600..CC-E/TC1.....		258	1SVR011781R0600..CC-E IAC/I.....		259
1SNA645041R0200..RB122G-115VUC.....		312	1SVR011703R2700..CC-E/I1.....		258	1SVR011782R0700..CC-E IAC/I.....		259
1SNA645046R0700..RB121R-115VUC.....		312	1SVR011705R2100..CC-E/STD.....		256	1SVR011783R0000..CC-E IDC/V.....		259
1SNA645047R0000..OBIC0100-5-12VDC.....		320	1SVR011706R2200..CC-E/RTD.....		257	1SVR011784R0100..CC-E IDC/I.....		259
1SNA645049R1200..OBIC0100-48-60VUC.....		320	1SVR011707R2300..CC-E/TC.....		258	1SVR011785R1100..CC-E IDC/I.....		259
1SNA645050R1700..OB0C2000-5-12VDC.....		320	1SVR011708R0400..CC-E/I.....		259	1SVR011788R2400..CC-E RTD/V.....		257
			1SVR011710R2100..CC-E V/V.....		256	1SVR011789R2500..CC-E RTD/I.....		257
						1SVR011790R2200..CC-E RTD/I.....		257

Index Numerical

Order code	Type	Page	Order code	Type	Page	Order code	Type	Page
1SVR011791R1700..CC-E RTD/V		257	1SVR405541R3210..CR-S024VADC1CRZ		286	1SVR405611R9000..CR-M220DC2		288
1SVR011792R1000..CC-E RTD/I		257	1SVR405541R3220..CR-S024VADC1CRGZ		286	1SVR405611R9100..CR-M220DC2L		289
1SVR011793R1100..CC-E RTD/I		257	1SVR405541R6110..CR-S110VADC1CRS		286	1SVR405612R0000..CR-M024AC3		288
1SVR011794R1200..CC-E RTD/V		257	1SVR405541R6120..CR-S110VADC1CRGS		286	1SVR405612R0100..CR-M024AC3L		289
1SVR011795R1300..CC-E RTD/I		257	1SVR405541R6210..CR-S110VADC1CRZ		286	1SVR405612R1000..CR-M024DC3		288
1SVR011796R1400..CC-E RTD/I		257	1SVR405541R6220..CR-S110VADC1CRGZ		286	1SVR405612R1100..CR-M024DC3L		289
1SVR011797R1500..CC-E RTD/V		257	1SVR405541R7110..CR-S230VADC1CRS		286	1SVR405612R2000..CR-M120AC3		288
1SVR011798R2600..CC-E RTD/I		257	1SVR405541R7120..CR-S230VADC1CRGS		286	1SVR405612R2100..CR-M120AC3L		289
1SVR011799R2700..CC-U/STD		257	1SVR405541R7210..CR-S230VADC1CRZ		286	1SVR405612R3000..CR-M230AC3		288
1SVR040000R1700..CC-U/STD		267	1SVR405541R7220..CR-S230VADC1CRGZ		286	1SVR405612R3100..CR-M230AC3L		289
1SVR040001R0400..CC-U/STD		267	1SVR405598R0700..CR-SJB20-BLUE		286	1SVR405612R4000..CR-M012DC3		288
1SVR040002R0500..CC-U/RTD		267	1SVR405598R0800..CR-SJB20-RED		286	1SVR405612R4100..CR-M012DC3L		289
1SVR040003R0600..CC-U/RTD		267	1SVR405598R0900..CR-SJB20-BLACK		286	1SVR405612R4200..CR-M060DC3		288
1SVR040004R0700..CC-U/TC		267	1SVR405599R0000..CR-SSEP		286	1SVR405612R4300..CR-M060DC3L		289
1SVR040005R0000..CC-U/TC		267	1SVR405600R0000..CR-P024AC1		287	1SVR405612R5000..CR-M048AC3		288
1SVR040006R0100..CC-U/I		267	1SVR405600R1000..CR-P024DC1		287	1SVR405612R5100..CR-M048AC3L		289
1SVR040007R0200..CC-U/I		267	1SVR405600R2000..CR-P120AC1		287	1SVR405612R5200..CR-M060AC3		288
1SVR040008R1300..CC-U/V		267	1SVR405600R3000..CR-P230AC1		287	1SVR405612R6000..CR-M048DC3		288
1SVR040009R1400..CC-U/V		267	1SVR405600R4000..CR-P012DC1		287	1SVR405612R6100..CR-M048DC3L		289
1SVR040010R0000..CC-U/STDR		267	1SVR405600R5000..CR-P048AC1		287	1SVR405612R7000..CR-M110AC3		288
1SVR040011R2500..CC-U/STDR		267	1SVR405600R6000..CR-P048DC1		287	1SVR405612R7100..CR-M110AC3L		289
1SVR040014R2000..CC-U/TCR		267	1SVR405600R7000..CR-P110AC1		287	1SVR405612R8000..CR-M110DC3		288
1SVR040015R2100..CC-U/TCR		267	1SVR405600R8000..CR-P110DC1		287	1SVR405612R8100..CR-M110DC3L		289
1SVR360563R1001..CP-C.1 24/5.0		222	1SVR405601R0000..CR-P024AC2		287	1SVR405612R8200..CR-M125DC3		288
1SVR360663R1001..CP-C.1 24/10.0		222	1SVR405601R1000..CR-P024DC2		287	1SVR405612R8300..CR-M125DC3L		289
1SVR360763R1001..CP-C.1 24/20.0		222	1SVR405601R2000..CR-P120AC2		287	1SVR405612R9000..CR-M220DC3		288
1SVR366017R0100..MAR.01		39	1SVR405601R3000..CR-P230AC2		287	1SVR405612R9100..CR-M220DC3L		289
1SVR366017R0100..MAR.01		39	1SVR405601R4000..CR-P012DC2		287	1SVR405613R0000..CR-M024AC4		288
1SVR366017R0100..MAR.01		176	1SVR405601R5000..CR-P048AC2		287	1SVR405613R0100..CR-M024AC4L		289
1SVR366017R0100..MAR.01		268	1SVR405601R6000..CR-P048DC2		287	1SVR405613R1000..CR-M024DC4		288
1SVR402902R0000..CM-HE		166	1SVR405601R7000..CR-P110AC2		287	1SVR405613R1100..CR-M024DC4L		289
1SVR402902R1000..CM-HC		166	1SVR405601R8000..CR-P110DC2		287	1SVR405613R2000..CR-M120AC4		288
1SVR402902R2000..CM-HCT		166	1SVR405606R0000..CR-P024AC2G		287	1SVR405613R2100..CR-M120AC4L		289
1SVR405501R1010..CR-S005VDC1R		286	1SVR405606R1000..CR-P024DC2		287	1SVR405613R3000..CR-M230AC4		288
1SVR405501R1020..CR-S005VDC1RG		286	1SVR405606R3000..CR-P230AC2G		287	1SVR405613R3100..CR-M230AC4L		289
1SVR405501R2010..CR-S012VDC1R		286	1SVR405606R7000..CR-P110AC2G		287	1SVR405613R4000..CR-M012DC4		288
1SVR405501R2020..CR-S012VDC1RG		286	1SVR405611R0000..CR-M024AC2		288	1SVR405613R4100..CR-M012DC4L		289
1SVR405501R3010..CR-S024VDC1R		286	1SVR405611R0100..CR-M024AC2L		289	1SVR405613R4200..CR-M060DC4		288
1SVR405501R3020..CR-S024VDC1RG		286	1SVR405611R1000..CR-M024DC2		288	1SVR405613R4300..CR-M060DC4L		289
1SVR405501R4010..CR-S048VDC1R		286	1SVR405611R1100..CR-M024DC2L		289	1SVR405613R5000..CR-M048AC4		288
1SVR405501R4020..CR-S048VDC1RG		286	1SVR405611R2000..CR-M120AC2		288	1SVR405613R5100..CR-M048AC4L		289
1SVR405501R5010..CR-S060VDC1R		286	1SVR405611R2100..CR-M120AC2L		289	1SVR405613R6000..CR-M048DC4		288
1SVR405501R5020..CR-S060VDC1RG		286	1SVR405611R3000..CR-M230AC2		288	1SVR405613R6100..CR-M048DC4L		289
1SVR405510R3050..CR-S024VDC1TRA		286	1SVR405611R3100..CR-M230AC2L		289	1SVR405613R7000..CR-M110AC4		288
1SVR405510R3060..CR-S024VDC1MOS		286	1SVR405611R4000..CR-M012DC2		288	1SVR405613R7100..CR-M110AC4L		289
1SVR405510R3070..CR-S024VDC1TRI		286	1SVR405611R4100..CR-M012DC2L		289	1SVR405613R8000..CR-M110DC4		288
1SVR405521R1100..CR-S006/024VDC1SS		286	1SVR405611R4200..CR-M060DC2		288	1SVR405613R8100..CR-M110DC4L		289
1SVR405521R1200..CR-S006/024VDC1SZ		286	1SVR405611R4300..CR-M060DC2L		289	1SVR405613R8200..CR-M125DC4		288
1SVR405521R3100..CR-S012/024VADC1SS		286	1SVR405611R5000..CR-M048AC2		288	1SVR405613R8300..CR-M125DC4L		289
1SVR405521R3200..CR-S012/024VADC1SZ		286	1SVR405611R5100..CR-M048AC2L		289	1SVR405613R9000..CR-M220DC4		288
1SVR405521R5100..CR-S048/060VADC1SS		286	1SVR405611R6000..CR-M048DC2		288	1SVR405613R9100..CR-M220DC4L		289
1SVR405521R5200..CR-S048/060VADC1SZ		286	1SVR405611R6100..CR-M048DC2L		289	1SVR405614R1100..CR-M024DC4LD		289
1SVR405521R6100..CR-S110/125VADC1SS		286	1SVR405611R7000..CR-M110AC2		288	1SVR405618R0000..CR-M024AC4G		289
1SVR405521R6200..CR-S110/125VADC1SZ		286	1SVR405611R7100..CR-M110AC2L		289	1SVR405618R0100..CR-M024AC4LG		290
1SVR405521R7100..CR-S220/240VADC1SS		286	1SVR405611R8000..CR-M110DC2		288	1SVR405618R1000..CR-M024DC4G		289
1SVR405521R7200..CR-S220/240VADC1SZ		286	1SVR405611R8100..CR-M110DC2L		289	1SVR405618R1100..CR-M024DC4LG		290
1SVR405541R3110..CR-S024VADC1CRS		286	1SVR405611R8200..CR-M125DC2		288	1SVR405618R1400..CR-M024DC4LDG		290
1SVR405541R3120..CR-S024VADC1CRGS		286	1SVR405611R8300..CR-M125DC2L		289	1SVR405618R2100..CR-M120AC4LG		290

Index Numerical

Order code	Type	Page	Order code	Type	Page	Order code	Type	Page
1SVR405618R3000..	CR-M230AC4G.....	289	1SVR405651R0000..	CR-P/M 22.....	291	1SVR405664R1100..	CR-U 91V.....	293
1SVR405618R3100..	CR-M230AC4LG.....	290	1SVR405651R1000..	CR-M2SS.....	290	1SVR405664R4000..	CR-U 61E.....	293
1SVR405618R4100..	CR-M012DC4LG.....	290	1SVR405651R1100..	CR-M2LS.....	290	1SVR405664R4100..	CR-U 61EV.....	293
1SVR405618R4300..	CR-M060DC4LG.....	290	1SVR405651R1200..	CR-M2LC.....	290	1SVR405665R0000..	CR-U 61C.....	293
1SVR405618R4400..	CR-M012DC4LDG.....	290	1SVR405651R1300..	CR-M2SF.....	290	1SVR405665R0100..	CR-U 91C.....	293
1SVR405618R5100..	CR-M048AC4LG.....	290	1SVR405651R2000..	CR-M3SS.....	290	1SVR405665R1000..	CR-U 61CV.....	293
1SVR405618R6100..	CR-M048DC4LG.....	290	1SVR405651R2100..	CR-M3LS.....	290	1SVR405665R1100..	CR-U 91CV.....	293
1SVR405618R7000..	CR-M110AC4G.....	289	1SVR405651R3000..	CR-M4SS.....	290	1SVR405665R4000..	CR-U 61D.....	293
1SVR405618R7100..	CR-M110AC4LG.....	290	1SVR405651R3100..	CR-M4LS.....	290	1SVR405665R4100..	CR-U 61DV.....	293
1SVR405618R8100..	CR-M110DC4LG.....	290	1SVR405651R3200..	CR-M4LC.....	290	1SVR405666R0000..	CR-U 71.....	293
1SVR405618R8300..	CR-M125DC4LG.....	290	1SVR405651R3300..	CR-M4SF.....	290	1SVR405666R1000..	CR-U 71A.....	293
1SVR405618R9100..	CR-M220DC4LG.....	290	1SVR405652R0000..	CR-P/M 42.....	291	1SVR405666R2000..	CR-U 81.....	293
1SVR405621R0000..	CR-U024AC2.....	292	1SVR405652R1000..	CR-P/M 42V.....	291	1SVR405667R0000..	CR-U T.....	293
1SVR405621R0100..	CR-U024AC2L.....	292	1SVR405652R4000..	CR-P/M 42B.....	291	1SVR405669R0000..	CR-UH.....	292
1SVR405621R1000..	CR-U024DC2.....	292	1SVR405652R4100..	CR-P/M 42BV.....	291	1SVR405670R0000..	CR-U2S.....	292
1SVR405621R1100..	CR-U024DC2L.....	292	1SVR405652R9000..	CR-P/M 42C.....	291	1SVR405670R1100..	CR-U2SM.....	292
1SVR405621R2000..	CR-U120AC2.....	292	1SVR405652R9100..	CR-P/M 42CV.....	291	1SVR423418R9000..	CP-RUD.....	229
1SVR405621R2100..	CR-U120AC2L.....	292	1SVR405653R0000..	CR-P/M 52B.....	291	1SVR427030R0000..	CP-E 24/0.75.....	198
1SVR405621R3000..	CR-U230AC2.....	292	1SVR405653R1000..	CR-P/M 52C.....	291	1SVR427030R2000..	CP-E 48/0.62.....	198
1SVR405621R3100..	CR-U230AC2L.....	292	1SVR405653R4000..	CR-P/M 52D.....	291	1SVR427031R0000..	CP-E 24/1.25.....	198
1SVR405621R4000..	CR-U012DC2.....	292	1SVR405654R0000..	CR-P/M 62.....	291	1SVR427031R2000..	CP-E 48/1.25.....	198
1SVR405621R4100..	CR-U012DC2L.....	292	1SVR405654R0100..	CR-P/M 92.....	291	1SVR427032R0000..	CP-E 24/2.5.....	198
1SVR405621R5000..	CR-U048AC2.....	292	1SVR405654R1000..	CR-P/M 62V.....	291	1SVR427032R1000..	CP-E 12/2.5.....	198
1SVR405621R5100..	CR-U048AC2L.....	292	1SVR405654R1100..	CR-P/M 92V.....	291	1SVR427033R3000..	CP-E 5/3.0.....	198
1SVR405621R6000..	CR-U048DC2.....	292	1SVR405654R4000..	CR-P/M 62E.....	291	1SVR427034R0000..	CP-E 24/5.0.....	198
1SVR405621R6100..	CR-U048DC2L.....	292	1SVR405654R4100..	CR-P/M 62EV.....	291	1SVR427034R2000..	CP-E 48/5.0.....	198
1SVR405621R7000..	CR-U110AC2.....	292	1SVR405655R0000..	CR-P/M 62C.....	291	1SVR427035R0000..	CP-E 24/10.0.....	198
1SVR405621R7100..	CR-U110AC2L.....	292	1SVR405655R0100..	CR-P/M 92C.....	291	1SVR427035R1000..	CP-E 12/10.0.....	198
1SVR405621R8000..	CR-U110DC2.....	292	1SVR405655R1000..	CR-P/M 62CV.....	291	1SVR427035R2000..	CP-E 48/10.0.....	198
1SVR405621R8100..	CR-U110DC2L.....	292	1SVR405655R1100..	CR-P/M 92CV.....	291	1SVR427036R0000..	CP-E 24/20.0.....	198
1SVR405621R9000..	CR-U220DC2.....	292	1SVR405655R4000..	CR-P/M 62D.....	291	1SVR427041R0000..	CP-D 24/0.42.....	188
1SVR405621R9100..	CR-U220DC2L.....	292	1SVR405655R4100..	CR-P/M 62DV.....	291	1SVR427041R1000..	CP-D 12/0.83.....	188
1SVR405622R0000..	CR-U024AC3.....	292	1SVR405656R0000..	CR-P/M 72.....	291	1SVR427043R0100..	CP-D 24/1.3.....	188
1SVR405622R0100..	CR-U024AC3L.....	292	1SVR405656R1000..	CR-P/M 72A.....	291	1SVR427043R1200..	CP-D 12/2.1.....	188
1SVR405622R1000..	CR-U024DC3.....	292	1SVR405656R2000..	CR-P/M 82.....	291	1SVR427044R0200..	CP-D 24/2.5.....	188
1SVR405622R1100..	CR-U024DC3L.....	292	1SVR405658R0000..	CR-PM.....	287	1SVR427045R0400..	CP-D 24/4.2.....	188
1SVR405622R2000..	CR-U120AC3.....	292	1SVR405658R1000..	CR-MM.....	290	1SVR427049R0000..	CP-D RU.....	229
1SVR405622R2100..	CR-U120AC3L.....	292	1SVR405658R5000..	CR-PJ.....	287	1SVR427054R0000..	CP-T 24/5.0.....	212
1SVR405622R3000..	CR-U230AC3.....	292	1SVR405658R6000..	CR-MJ.....	290	1SVR427054R2000..	CP-T 48/5.0.....	212
1SVR405622R3100..	CR-U230AC3L.....	292	1SVR405659R0000..	CR-PH.....	287	1SVR427055R0000..	CP-T 24/10.0.....	212
1SVR405622R4000..	CR-U012DC3.....	292	1SVR405659R1000..	CR-MH.....	290	1SVR427055R2000..	CP-T 48/10.0.....	212
1SVR405622R4100..	CR-U012DC3L.....	292	1SVR405659R1100..	CR-MH1.....	290	1SVR427056R0000..	CP-T 24/20.0.....	212
1SVR405622R5000..	CR-U048AC3.....	292	1SVR405660R0000..	CR-U3S.....	292	1SVR427056R2000..	CP-T 48/20.0.....	212
1SVR405622R5100..	CR-U048AC3L.....	292	1SVR405660R0100..	CR-U3E.....	292	1SVR427057R0000..	CP-T 24/40.0.....	212
1SVR405622R5200..	CR-U060AC3.....	292	1SVR405660R1100..	CR-U3SM.....	292	1SVR427060R0300..	CP-B 24/3.0.....	238
1SVR405622R6000..	CR-U048DC3.....	292	1SVR405661R0000..	CR-U 21.....	293	1SVR427060R1000..	CP-B 24/10.0.....	238
1SVR405622R6100..	CR-U048DC3L.....	292	1SVR405662R0000..	CR-U 41.....	293	1SVR427060R2000..	CP-B 24/20.0.....	238
1SVR405622R7000..	CR-U110AC3.....	292	1SVR405662R1000..	CR-U 41V.....	293	1SVR427065R0000..	CP-B EXT.2.....	238
1SVR405622R7100..	CR-U110AC3L.....	292	1SVR405662R4000..	CR-U 41B.....	293	1SVR427071R0000..	CP-A RU.....	229
1SVR405622R8000..	CR-U110DC3.....	292	1SVR405662R4100..	CR-U 41BV.....	293	1SVR427075R0000..	CP-A CM.....	229
1SVR405622R8100..	CR-U110DC3L.....	292	1SVR405662R9000..	CR-U 41C.....	293	1SVR430005R0100..	COV.01.....	39
1SVR405622R8200..	CR-U125DC3.....	292	1SVR405662R9100..	CR-U 41CV.....	293	1SVR430005R0100..	COV.01.....	176
1SVR405622R9000..	CR-U220DC3.....	292	1SVR405663R0000..	CR-U 51B.....	293	1SVR430005R0100..	COV.01.....	268
1SVR405622R9100..	CR-U220DC3L.....	292	1SVR405663R1000..	CR-U 51C.....	293	1SVR430029R0100..	ADP.01.....	39
1SVR405650R0000..	CR-PLS.....	287	1SVR405663R4000..	CR-U 51D.....	293	1SVR430029R0100..	ADP.01.....	39
1SVR405650R0100..	CR-PLSx.....	287	1SVR405664R0000..	CR-U 61.....	293	1SVR430029R0100..	ADP.01.....	176
1SVR405650R0200..	CR-PLC.....	287	1SVR405664R0100..	CR-U 91.....	293	1SVR430029R0100..	ADP.01.....	268
1SVR405650R1000..	CR-PSS.....	287	1SVR405664R1000..	CR-U 61V.....	293	1SVR430043R0000..	MAR.02.....	39

Index Numerical

Order code	Type	Page	Order code	Type	Page	Order code	Type	Page
1SVR430043R0000..MAR.02		176	1SVR440899R6400..CL-LAD.TK005		333	1SVR550100R2100..CT-ERE		27
1SVR440005R0100..COV.02		176	1SVR440899R6500..CL-LAD.TK006		333	1SVR550100R4100..CT-ERE		26
1SVR440029R0100..ADP.02		176	1SVR440899R6600..CL-LAD.TK007		332	1SVR550100R4100..CT-ERE		27
1SVR440709R0000..CL-LEC.CI000		331	1SVR440899R6700..CL-LAD.TK011		333	1SVR550100R5100..CT-ERE		26
1SVR440709R5000..CL-LER.20		331	1SVR440899R6900..CL-LAD.TK009		333	1SVR550100R5100..CT-ERE		27
1SVR440710R0200..CL-LSR.CX12DC1		330	1SVR440899R7000..CL-LAD.MD004		333	1SVR550107R1100..CT-ERE		26
1SVR440710R0300..CL-LSR.C12DC1		330	1SVR450056R0000..CM-SE-300		166	1SVR550107R1100..CT-ERE		27
1SVR440711R0100..CL-LSR.12DC2		330	1SVR450056R0100..CM-SE-600		166	1SVR550107R2100..CT-ERE		26
1SVR440711R0200..CL-LSR.CX12DC2		330	1SVR450056R0200..CM-SE-1000		166	1SVR550107R2100..CT-ERE		27
1SVR440711R0300..CL-LSR.C12DC2		330	1SVR450056R6000..CM-KH-3		166	1SVR550107R4100..CT-ERE		26
1SVR440711R1200..CL-LST.CX12DC2		330	1SVR450056R7000..CM-AH-3		166	1SVR550107R4100..CT-ERE		27
1SVR440711R1300..CL-LST.C12DC2		330	1SVR450056R8000..CM-GM-1		166	1SVR550107R5100..CT-ERE		26
1SVR440712R0200..CL-LSR.CX12AC1		330	1SVR450116R1000..CM-CT 50/1		177	1SVR550107R5100..CT-ERE		27
1SVR440712R0300..CL-LSR.C12AC1		330	1SVR450116R1100..CM-CT 75/1		177	1SVR550110R1100..CT-AHE		26
1SVR440713R0100..CL-LSR.12AC2		330	1SVR450116R1200..CM-CT 100/1		177	1SVR550110R1100..CT-AHE		27
1SVR440713R0200..CL-LSR.CX12AC2		330	1SVR450116R1300..CM-CT 150/1		177	1SVR550110R2100..CT-AHE		26
1SVR440713R0300..CL-LSR.C12AC2		330	1SVR450116R1400..CM-CT 200/1		177	1SVR550110R2100..CT-AHE		27
1SVR440720R0200..CL-LMR.CX18DC1		331	1SVR450116R5000..CM-CT 50/5		177	1SVR550110R4100..CT-AHE		26
1SVR440720R0300..CL-LMR.C18DC1		331	1SVR450116R5100..CM-CT 75/5		177	1SVR550110R4100..CT-AHE		27
1SVR440721R0000..CL-LER.18DC2		331	1SVR450116R5200..CM-CT 100/5		177	1SVR550111R1100..CT-AHE		26
1SVR440721R0200..CL-LMR.CX18DC2		331	1SVR450116R5300..CM-CT 150/5		177	1SVR550111R1100..CT-AHE		27
1SVR440721R0300..CL-LMR.C18DC2		331	1SVR450116R5400..CM-CT 200/5		177	1SVR550111R2100..CT-AHE		26
1SVR440721R1000..CL-LET.20DC2		331	1SVR450117R1100..CM-CT 300/1		177	1SVR550111R2100..CT-AHE		27
1SVR440721R1200..CL-LMT.CX20DC2		331	1SVR450117R1200..CM-CT 400/1		177	1SVR550111R4100..CT-AHE		26
1SVR440721R1300..CL-LMT.C20DC2		331	1SVR450117R1300..CM-CT 500/1		177	1SVR550111R4100..CT-AHE		27
1SVR440722R0200..CL-LMR.CX18AC1		331	1SVR450117R1400..CM-CT 600/1		177	1SVR550118R1100..CT-AHE		26
1SVR440722R0300..CL-LMR.C18AC1		331	1SVR450117R5100..CM-CT 300/5		177	1SVR550118R1100..CT-AHE		27
1SVR440723R0000..CL-LER.18AC2		331	1SVR450117R5200..CM-CT 400/5		177	1SVR550118R2100..CT-AHE		26
1SVR440723R0200..CL-LMR.CX18AC2		331	1SVR450117R5300..CM-CT 500/5		177	1SVR550118R2100..CT-AHE		27
1SVR440723R0300..CL-LMR.C18AC2		331	1SVR450117R5400..CM-CT 600/5		177	1SVR550118R4100..CT-AHE		26
1SVR440799R5000..CL-LAS.FD001		332	1SVR450118R1000..CM-CT A		177	1SVR550118R4100..CT-AHE		27
1SVR440799R5100..CL-LAS.TK011		332	1SVR450330R0000..CM-LWN		126	1SVR550120R1100..CT-ARE		26
1SVR440799R6000..CL-LAS.TK001		332	1SVR450330R0100..CM-LWN		126	1SVR550120R1100..CT-ARE		27
1SVR440799R6100..CL-LAS.TK002		332	1SVR450331R0000..CM-LWN		126	1SVR550120R4100..CT-ARE		26
1SVR440799R7000..CL-LAS.MD003		332	1SVR450331R0100..CM-LWN		126	1SVR550120R4100..CT-ARE		27
1SVR440799R8000..CL-LAS.PS002		332	1SVR450332R0000..CM-LWN		126	1SVR550127R1100..CT-ARE		26
1SVR440821R0000..CL-LDC.LDC2		333	1SVR450332R0100..CM-LWN		126	1SVR550127R1100..CT-ARE		27
1SVR440821R1000..CL-LDC.LNDC2		333	1SVR450334R0000..CM-LWN		126	1SVR550127R4100..CT-ARE		26
1SVR440823R0000..CL-LDC.LAC2		333	1SVR450334R0100..CM-LWN		126	1SVR550127R4100..CT-ARE		27
1SVR440823R1000..CL-LDC.LNAC2		333	1SVR450335R0000..CM-LWN		126	1SVR550130R1100..CT-VWE		26
1SVR440839R4400..CL-LDD.K		330	1SVR450335R0100..CM-LWN		126	1SVR550130R1100..CT-VWE		27
1SVR440839R4400..CL-LDD.K		333	1SVR500020R0000..CT-MFD.12		18	1SVR550130R2100..CT-VWE		26
1SVR440839R4500..CL-LDD.XK		330	1SVR500020R1100..CT-MFD.21		18	1SVR550130R2100..CT-VWE		27
1SVR440839R4500..CL-LDD.XK		333	1SVR500100R0000..CT-ERD.12		18	1SVR550130R4100..CT-VWE		26
1SVR440841R0000..CL-LDC.SDC2		330	1SVR500100R0100..CT-ERD.22		18	1SVR550130R4100..CT-VWE		27
1SVR440843R0000..CL-LDC.SAC2		330	1SVR500110R0000..CT-AHD.12		18	1SVR550137R1100..CT-VWE		26
1SVR440851R0000..CL-LDR.16DC2		333	1SVR500110R0100..CT-AHD.22		18	1SVR550137R1100..CT-VWE		27
1SVR440851R1000..CL-LDT.16DC2		333	1SVR500130R0000..CT-VWD.12		18	1SVR550137R2100..CT-VWE		26
1SVR440851R2000..CL-LDR.17DC2		333	1SVR500150R0000..CT-EBD.12		18	1SVR550137R2100..CT-VWE		27
1SVR440851R3000..CL-LDT.17DC2		333	1SVR500160R0000..CT-TGD.12		18	1SVR550137R4100..CT-VWE		26
1SVR440853R0000..CL-LDR.16AC2		333	1SVR500160R0100..CT-TGD.22		18	1SVR550137R4100..CT-VWE		27
1SVR440899R1000..CL-LAD.FD001		333	1SVR500210R0100..CT-SAD.22		18	1SVR550150R3100..CT-AWE		26
1SVR440899R2000..CL-LAD.FD011		333	1SVR500211R0100..CT-SDD.22		18	1SVR550150R3100..CT-AWE		27
1SVR440899R3000..CL-LAD.FD002		333	1SVR550029R8100..CT-MFE		26	1SVR550151R3100..CT-AWE		26
1SVR440899R6000..CL-LAD.TK001		333	1SVR550029R8100..CT-MFE		27	1SVR550151R3100..CT-AWE		27
1SVR440899R6100..CL-LAD.TK002		333	1SVR550100R1100..CT-ERE		26	1SVR550158R3100..CT-AWE		26
1SVR440899R6200..CL-LAD.TK003		333	1SVR550100R1100..CT-ERE		27	1SVR550158R3100..CT-AWE		27
1SVR440899R6300..CL-LAD.TK004		333	1SVR550100R2100..CT-ERE		26	1SVR550800R9300..CM-MSE		140

Index Numerical

Order code	Type	Page	Order code	Type	Page	Order code	Type	Page
1SVR550801R9300	.. CM-MSE	140	1SVR730740R0100	.. CM-TCS.11S	154	1SVR740100R3100	.. CT-ERS.12P	38
1SVR550805R9300	.. CM-MSE	140	1SVR730740R0200	.. CM-TCS.12S	154	1SVR740100R3300	.. CT-ERS.22P	38
1SVR550824R9100	.. CM-PFE	82	1SVR730740R0300	.. CM-TCS.13S	154	1SVR740110R3300	.. CT-AHS.22P	38
1SVR550826R9100	.. CM-PFE.2	82	1SVR730740R9100	.. CM-TCS.21S	154	1SVR740120R3100	.. CT-ARS.11P	38
1SVR550850R9400	.. CM-ENE MAX	166	1SVR730740R9200	.. CM-TCS.22S	154	1SVR740120R3300	.. CT-ARS.21P	38
1SVR550850R9500	.. CM-ENE MIN	166	1SVR730740R9300	.. CM-TCS.23S	154	1SVR740180R0300	.. CT-APS.21P	38
1SVR550851R9400	.. CM-ENE MAX	166	1SVR730750R0400	.. CM-EFS.2S	66	1SVR740180R3100	.. CT-APS.12P	38
1SVR550851R9500	.. CM-ENE MIN	166	1SVR730760R0400	.. CM-SFS.21S	64	1SVR740180R3300	.. CT-APS.22P	38
1SVR550855R9400	.. CM-ENE MAX	166	1SVR730760R0500	.. CM-SFS.22S	64	1SVR740210R3300	.. CT-SDS.22P	38
1SVR550855R9500	.. CM-ENE MIN	166	1SVR730774R1300	.. CM-PAS.31S	82	1SVR740211R2300	.. CT-SDS.23P	38
1SVR550870R9400	.. CM-PVE	82	1SVR730774R3300	.. CM-PAS.41S	82	1SVR740660R0100	.. CM-IWS.1P	116
1SVR550871R9500	.. CM-PVE	82	1SVR730784R2300	.. CM-PSS.31S	82	1SVR740670R0200	.. CM-IWS.2P	116
1SVR550881R9400	.. CM-PBE	82	1SVR730784R3300	.. CM-PSS.41S	82	1SVR740700R0100	.. CM-MSS.12P	140
1SVR550882R9500	.. CM-PBE	82	1SVR730794R1300	.. CM-PVS.31S	82	1SVR740700R0200	.. CM-MSS.22P	140
1SVR560730R3400	.. CM-UFD.M22	104	1SVR730794R2300	.. CM-PVS.81S	82	1SVR740700R2100	.. CM-MSS.13P	140
1SVR560730R3401	.. CM-UFD.M31	104	1SVR730794R3300	.. CM-PVS.41S	82	1SVR740700R2200	.. CM-MSS.23P	140
1SVR560730R3402	.. CM-UFD.M33	104	1SVR730824R9300	.. CM-PFS.S	82	1SVR740712R0200	.. CM-MSS.32P	140
1SVR560730R3403	.. CM-UFD.M34	104	1SVR730830R0300	.. CM-ESS.1S	66	1SVR740712R1200	.. CM-MSS.41P	140
1SVR700101R0100	.. C512-D	154	1SVR730830R0400	.. CM-ESS.2S	66	1SVR740712R1300	.. CM-MSS.51P	140
1SVR700102R0100	.. C512-E	154	1SVR730830R0500	.. CM-ESS.MS	66	1SVR740712R1400	.. CM-MSS.31P	140
1SVR700111R0100	.. C513-D	154	1SVR730831R0300	.. CM-ESS.1S	66	1SVR740712R2200	.. CM-MSS.33P	140
1SVR700112R0100	.. C513-E	154	1SVR730831R0400	.. CM-ESS.2S	66	1SVR740720R1400	.. CM-MSS.11P	140
1SVR730005R0100	.. COV.11	39	1SVR730831R1300	.. CM-ESS.1S	66	1SVR740722R1400	.. CM-MSS.21P	140
1SVR730005R0100	.. COV.11	176	1SVR730831R1400	.. CM-ESS.2S	66	1SVR740740R0100	.. CM-TCS.11P	154
1SVR730006R0000	.. MAR.12	39	1SVR730840R0200	.. CM-SRS.11S	64	1SVR740740R0200	.. CM-TCS.12P	154
1SVR730006R0000	.. MAR.12	176	1SVR730840R0300	.. CM-SRS.12S	64	1SVR740740R0300	.. CM-TCS.13P	154
1SVR730010R0200	.. CT-MFS.21S	37	1SVR730840R0400	.. CM-SRS.21S	64	1SVR740740R9100	.. CM-TCS.21P	154
1SVR730010R3200	.. CT-MBS.22S	37	1SVR730840R0500	.. CM-SRS.22S	64	1SVR740740R9200	.. CM-TCS.22P	154
1SVR730020R0200	.. CT-MVS.21S	37	1SVR730840R0600	.. CM-SRS.M1S	64	1SVR740740R9300	.. CM-TCS.23P	154
1SVR730020R3100	.. CT-MVS.12S	37	1SVR730840R0700	.. CM-SRS.M2S	64	1SVR740750R0400	.. CM-EFS.2P	66
1SVR730020R3300	.. CT-MVS.22S	37	1SVR730841R0200	.. CM-SRS.11S	64	1SVR740760R0400	.. CM-SFS.21P	64
1SVR730021R2300	.. CT-MVS.23S	37	1SVR730841R0300	.. CM-SRS.12S	64	1SVR740774R1300	.. CM-PAS.31P	82
1SVR730030R3300	.. CT-MXS.22S	37	1SVR730841R0400	.. CM-SRS.21S	64	1SVR740774R3300	.. CM-PAS.41P	82
1SVR730040R3300	.. CT-WBS.22S	37	1SVR730841R0500	.. CM-SRS.22S	64	1SVR740784R2300	.. CM-PSS.31P	82
1SVR730100R0300	.. CT-ERS.21S	38	1SVR730841R1200	.. CM-SRS.11S	64	1SVR740784R3300	.. CM-PSS.41P	82
1SVR730100R3100	.. CT-ERS.12S	38	1SVR730841R1300	.. CM-SRS.12S	64	1SVR740794R1300	.. CM-PVS.31P	82
1SVR730100R3300	.. CT-ERS.22S	38	1SVR730841R1400	.. CM-SRS.21S	64	1SVR740794R2300	.. CM-PVS.81P	82
1SVR730110R3300	.. CT-AHS.22S	38	1SVR730841R1500	.. CM-SRS.22S	64	1SVR740794R3300	.. CM-PVS.41P	82
1SVR730120R3100	.. CT-ARS.11S	38	1SVR730850R0100	.. CM-ENS.11S	166	1SVR740824R9300	.. CM-PFS.P	82
1SVR730120R3300	.. CT-ARS.21S	38	1SVR730850R0200	.. CM-ENS.21S	166	1SVR740830R0300	.. CM-ESS.1P	66
1SVR730180R0300	.. CT-APS.21S	38	1SVR730850R0300	.. CM-ENS.31S	166	1SVR740830R0400	.. CM-ESS.2P	66
1SVR730180R3100	.. CT-APS.12S	38	1SVR730850R2100	.. CM-ENS.11P	166	1SVR740830R0500	.. CM-ESS.MP	66
1SVR730180R3300	.. CT-APS.22S	38	1SVR730850R2200	.. CM-ENS.23S	166	1SVR740831R0300	.. CM-ESS.1P	66
1SVR730210R3300	.. CT-SDS.22S	38	1SVR730884R1300	.. CM-MPS.31S	84	1SVR740831R0400	.. CM-ESS.2P	66
1SVR730211R2300	.. CT-SDS.23S	38	1SVR730884R3300	.. CM-MPS.41S	84	1SVR740831R1300	.. CM-ESS.1P	66
1SVR730660R0100	.. CM-IWS.1S	116	1SVR730884R4300	.. CM-MPS.43S	84	1SVR740831R1400	.. CM-ESS.2P	66
1SVR730670R0200	.. CM-IWS.2S	116	1SVR730885R1300	.. CM-MPS.11S	84	1SVR740840R0200	.. CM-SRS.11P	64
1SVR730700R0100	.. CM-MSS.12S	140	1SVR730885R3300	.. CM-MPS.21S	84	1SVR740840R0400	.. CM-SRS.21P	64
1SVR730700R0200	.. CM-MSS.22S	140	1SVR730885R4300	.. CM-MPS.23S	84	1SVR740840R0600	.. CM-SRS.M1P	64
1SVR730700R2100	.. CM-MSS.13S	140	1SVR740010R0200	.. CT-MFS.21P	37	1SVR740841R0200	.. CM-SRS.11P	64
1SVR730700R2200	.. CM-MSS.23S	140	1SVR740010R3200	.. CT-MBS.22P	37	1SVR740841R0400	.. CM-SRS.21P	64
1SVR730712R0200	.. CM-MSS.32S	140	1SVR740020R0200	.. CT-MVS.21P	37	1SVR740841R1200	.. CM-SRS.11P	64
1SVR730712R1200	.. CM-MSS.41S	140	1SVR740020R3100	.. CT-MVS.12P	37	1SVR740841R1400	.. CM-SRS.21P	64
1SVR730712R1300	.. CM-MSS.51S	140	1SVR740020R3300	.. CT-MVS.22P	37	1SVR740850R0100	.. CM-ENS.13S	166
1SVR730712R1400	.. CM-MSS.31S	140	1SVR740021R2300	.. CT-MVS.23P	37	1SVR740850R0200	.. CM-ENS.21P	166
1SVR730712R2200	.. CM-MSS.33S	140	1SVR740030R3300	.. CT-MXS.22P	37	1SVR740850R0300	.. CM-ENS.31P	166
1SVR730720R1400	.. CM-MSS.11S	140	1SVR740040R3300	.. CT-WBS.22P	37	1SVR740850R2100	.. CM-ENS.13P	166
1SVR730722R1400	.. CM-MSS.21S	140	1SVR740100R0300	.. CT-ERS.21P	38	1SVR740850R2200	.. CM-ENS.23P	166

Index

Numerical

Order code	Type	Page	Order code	Type	Page	Order code	Type	Page
1SVR740884R1300..	CM-MPS.31P.....	84						
1SVR740884R3300..	CM-MPS.41P.....	84						
1SVR740884R4300..	CM-MPS.43P.....	84						
1SVR740885R1300..	CM-MPS.11P.....	84						
1SVR740885R3300..	CM-MPS.21P.....	84						
1SVR740885R4300..	CM-MPS.23P.....	84						
1SVR750005R0100..	COV.12.....	176						
1SVR750487R8300..	CM-MPN.52S.....	84						
1SVR750488R8300..	CM-MPN.62S.....	84						
1SVR750489R8300..	CM-MPN.72S.....	84						
1SVR750660R0200..	CM-IWN.1S.....	116						
1SVR750660R0300..	CM-IWN.4S.....	116						
1SVR750660R0400..	CM-IWN.5S.....	116						
1SVR750660R0500..	CM-IWN.6S.....	116						
1SVR750669R9400..	CM-IVN.S.....	116						
1SVR760487R8300..	CM-MPN.52P.....	84						
1SVR760488R8300..	CM-MPN.62P.....	84						
1SVR760489R8300..	CM-MPN.72P.....	84						
1SVR760660R0200..	CM-IWN.1P.....	116						
1SVR760660R0300..	CM-IWN.4P.....	116						
1SVR760660R0400..	CM-IWN.5P.....	116						
1SVR760660R0500..	CM-IWN.6P.....	116						
1SVR760669R9400..	CM-IVN.P.....	116						

2CDE

2CDE601101R2001..	EPD24-TB-101-1A.....	245
2CDE601101R2002..	EPD24-TB-101-2A.....	245
2CDE601101R2003..	EPD24-TB-101-3A.....	245
2CDE601101R2004..	EPD24-TB-101-4A.....	245
2CDE601101R2006..	EPD24-TB-101-6A.....	245
2CDE601101R2008..	EPD24-TB-101-8A.....	245
2CDE601101R2010..	EPD24-TB-101-10A.....	245
2CDE601101R2012..	EPD24-TB-101-12A.....	245
2CDE601101R2905..	EPD24-TB-101-0.5A.....	245
2CDE605100R0500..	EPD-BB500.....	245
2CDE605200R0021..	EPD-SB21.....	245

GHC

GHC0110003R0001..	C011-70.....	140
GHC0110003R0002..	C011-80.....	140
GHC0110003R0003..	C011-90.....	140
GHC0110003R0004..	C011-100.....	140
GHC0110003R0005..	C011-110.....	140
GHC0110003R0006..	C011-120.....	140
GHC0110003R0007..	C011-130.....	140
GHC0110003R0008..	C011-150.....	140
GHC0110003R0009..	C011-160.....	140
GHC0110003R0010..	C011-170.....	140
GHC0110003R0011..	C011-140.....	140
GHC0110033R0008..	C011-3-150.....	140

GJD

GJD6155620R0087..	SK 615 562-87.....	39
GJD6155620R0088..	SK 615 562-88.....	39

Index
Numerical

Contact us

ABB STOTZ-KONTAKT GmbH

You can find the address of your local sales organisation on the ABB homepage:

www.abb.com/contacts

> Low Voltage Products and Systems

Find out more about electronic relays and controls on:

<http://new.abb.com/low-voltage/products/electronicrelays>

Note: We reserve the right to make technical changes or modify the contents of this document without prior notice. With regard to purchase orders, the agreed particulars shall prevail. ABB AG does not accept any responsibility whatsoever for potential errors or possible lack of information in this document.

We reserve all rights in this document and in the subject matter and illustrations contained therein. Any reproduction, disclosure to third parties or utilization of its contents – in whole or in parts – is forbidden without prior written consent of ABB AG.

Copyright © 2016 ABB
All rights reserved